



KRAMER ELECTRONICS LTD.

USER MANUAL

MODEL:

MODULAR TBUS-3xl
Table Connection Bus

P/N: 2900-300062 Rev 3

TBUS-3xl Quick Start Guide

This page guides you through a basic installation and first-time use of your **TBUS-3xl**. For more detailed information, see the **TBUS-3xl** user manual and modular instruction sheets. You can download the latest manual at <http://www.kramerelectronics.com>.

Step 1: Check what's in the box

- ✓ **TBUS-3xl** Table Connection Bus Enclosure
- ✓ 2 table clamps
- ✓ 6 self locking ties
- ✓ 1 Cut out Template
- ✓ 1 Quick start guide
- ✓ 1 User Manual

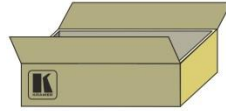

Save the original box and packaging materials in case your Kramer product needs to be returned to the factory for service.

Step 2: Prepare the TBUS-3xl for mounting

Assemble the Inner Frame and install the power socket (if required).

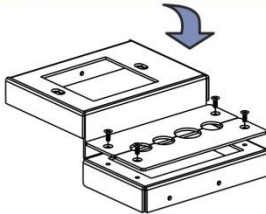

Mount the Inner Frame into the **TBUS-3xl** enclosure.

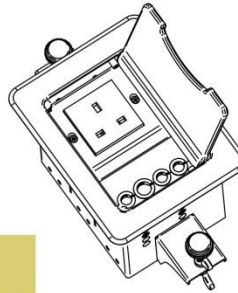

Adjust the height of the Inner Frame.

Step 3: Prepare the table for mounting

Cut out an opening in the table using the cut out template.

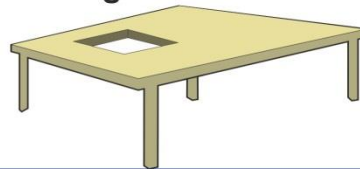

Step 4: Install the TBUS-3xl to the table

Insert the Unit through the table opening.

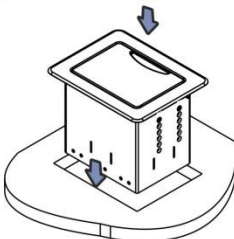

Secure the unit to the table.

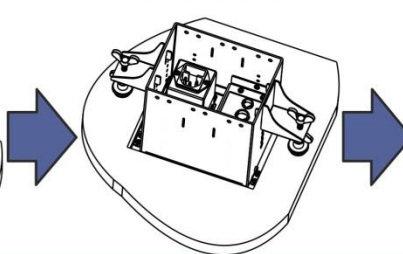

Connect the cables.

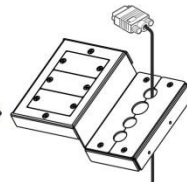

Contents

1	Introduction	1
2	Getting Started	2
2.1	Achieving the Best Performance	2
2.2	Glossary	2
3	Overview	3
4	Your TBUS-3xl Enclosure	4
4.1	TBUS-3xl Optional Inner Frames	5
4.2	TBUS-3xl Accessories	5
4.3	Power Socket Options	6
4.4	Power Cord Options	8
5	Installing the TBUS-3xl	9
5.1	Assembling the Inner Frame	9
5.2	Installing the Inner Frame	11
5.3	Cutting an Opening in the Table	11
5.4	Inserting the TBUS-3xl through the Cut Out Opening	12
5.5	Connecting the Cables	13
5.6	Inserting Cables via the 4-cable Pass-through Insert	13
5.7	Inserting the Pass-through Cables	14
5.8	Adjusting the Height of the Inner frame	15
6	Using the TBUS-3xl	16
7	Technical Specifications of the Assembled TBUS-3xl	17

Figures

Figure 1:	TBUS-3xl inside a Table	3
Figure 2:	TBUS-3xl Enclosure Top View	4
Figure 3:	TBUS-3xl Inner Frame (P/N: 80-003099)	10
Figure 4:	Cut out Dimensions	11
Figure 5:	Inserting TBUS-3xl into the Prepared Opening	12
Figure 6:	4-cable Pass-through Insert (P/N: 80-003199)	14
Figure 7:	TBUS-3xl Boardroom Installation	16

1 Introduction

Welcome to Kramer Electronics! Since 1981, Kramer Electronics has been providing a world of unique, creative, and affordable solutions to the vast range of problems that confront the video, audio, presentation, and broadcasting professional on a daily basis. In recent years, we have redesigned and upgraded most of our line, making the best even better!

Our 1,000-plus different models now appear in 11 groups that are clearly defined by function: GROUP 1: Distribution Amplifiers, GROUP 2: Switchers and Matrix Switchers, GROUP 3: Control Systems, GROUP 4: Format/Standards Converters, GROUP 5: Range Extenders and Repeaters, GROUP 6: Specialty AV Products, GROUP 7: Scan Converters and Scalers, GROUP 8: Cables and Connectors, GROUP 9: Room Connectivity, GROUP 10: Accessories and Rack Adapters and GROUP 11: Sierra Products.

Thank you for purchasing the Kramer **TBUS-3xl** enclosure, which is ideal for boardrooms, conference and training rooms!



Note that the inner frame, power socket assembly, power cord and other inserts for the **TBUS-3xl** enclosure are purchased separately.

2 Getting Started

We recommend that you:

- Unpack the equipment carefully and save the original box and packaging materials for possible future shipment
- Review the contents of this user manual
- Use Kramer high-performance high-resolution cables



Go to www.kramerav.com to check for up-to-date user manuals, a complete list of Kramer wall plates and module connectors, application programs, and to check if firmware upgrades are available (where appropriate).

2.1 Achieving the Best Performance

To achieve the best performance:

- Use only good quality connection cables to avoid interference, deterioration in signal quality due to poor matching, and elevated noise levels (often associated with low quality cables)
- Avoid interference from neighboring electrical appliances that may adversely influence signal quality
- Position your Kramer **TBUS-3xI** away from moisture, excessive sunlight and dust

2.2 Glossary

Inner frame	The inner frame fits into the TBUS enclosure
Universal socket	The Universal socket fits almost all power cords, worldwide
Insert	The insert is fitted in the inner frame. Go to our Web site to check for a variety of single and dual sized inserts

3 Overview

The Kramer **TBUS-3xl** is a high-quality, anodized aluminum, table-mounted connection bus enclosure for boardrooms and conference rooms. Its attractive enclosure is designed to provide maximum connectivity in the smallest possible footprint. The unit is sturdy, cost-effective, and easy to install.

The **TBUS-3xl** features:

- A modular design, letting you tailor the **TBUS-3xl** according to your requirements
- A black anodized or brushed clear aluminum lid with a special opening for cable pass-through (note, that other customized colors can also be ordered)
- Height adjustment screw holes to set the inner frame (ordered separately) to the desired height
- Power socket openings that are suitable for any of the following power sockets: for the USA, Germany (the Europlug), Belgium-France, Italy, Australia, Israel, South Africa or "Universal" for use anywhere (see compatibility restrictions in [Section 7](#))

Order the power sockets separately from Kramer Electronics

TBUS-3xl is height-adjustable and the cover opens and closes manually, keeping the cables and the connectors out of sight when not used.



Figure 1: TBUS-3xl inside a Table



Do not place heavy objects on top of the **TBUS-3xl**.

4 Your TBUS-3xl Enclosure

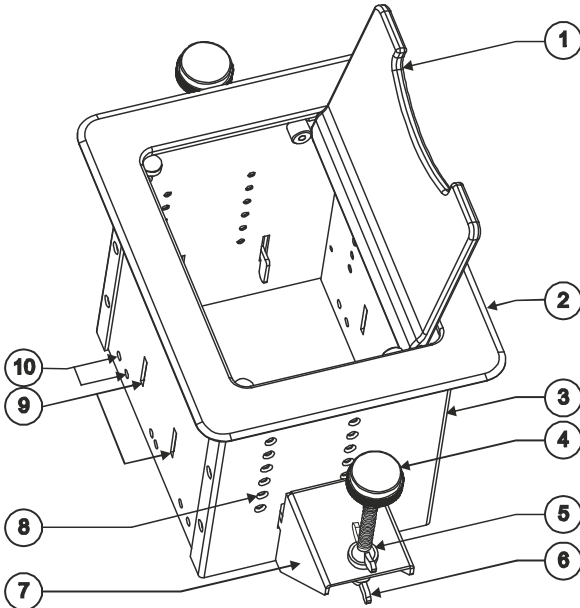

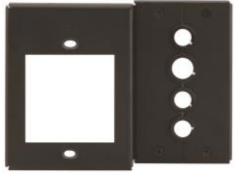

Figure 2: TBUS-3xl Enclosure Top View

#	Feature	Function	
1	Black Anodized/Brushed Clear Textured Lid	Includes an opening for cable pass-through; covers the inner frame, leaving the table surface neat and tidy	
2	Outer Rim	Fits over the table surface. A protective rubber guard protects the outer rim during shipping. Remove it before installing the unit	
3	Enclosure	Inserted into the table cut out	
4	Table Clamping Set	Rubber Protectors	Protect the table surface when mounting the unit and ensure soft tightening to the table underside (one for each clamp)
5		Locking Butterfly Screws	Tighten to lock the mounting butterfly screw (one for each clamp)
6		Mounting Butterfly Screws	Tighten to secure the unit to the table surface (one for each clamp)
7		Mounting Brackets (2 units)	Fit in the bracket slits after inserting the enclosure into the table – to secure the unit to the table surface (one for each clamp)
8	Height Adjustment Screw holes	The screw holes on each side panel are used for adjusting the height of the inner frame	
9	Bracket Slits	For attaching the two mounting brackets on opposite sides	
10	Tie Holes	Insert the self-locking tie through the holes to fix the pass-through cables to the inside walls of the unit	

4.1 TBUS-3xl Optional Inner Frames

The following inner frames can be installed in the **TBUS-3xl** enclosure:

Inner Frames for TBUS-3xl	Specifications (define what you can include in this inner frame):
	<p>T3F-1S (P/N: 80-002999)</p> <ul style="list-style-type: none"> 1 opening for 1 power socket 1 USB connector 1 VGA 15-pin HD connector 1 RJ-45 Ethernet connector A 3.5mm mini jack AUDIO connector
	<p>T3F-13 (P/N: 80-003099)</p> <ul style="list-style-type: none"> 1 opening for 1 power socket 2 blank inserts 1 cable pass-through insert
	<p>T3F-1C (P/N: 80-003199)</p> <ul style="list-style-type: none"> 1 opening for 1 power socket 4-cable pass-through insert



Custom made inner frames can be designed if required.
Contact Kramer Electronics for more details.

4.2 TBUS-3xl Accessories

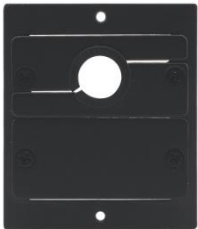





Accessories	Description
<p>Inserts</p>	<p>You can install any wall plate devices as well as any of the single or dual inserts—see our Web site for details.</p>
	<p>T-2INSERT (P/N: 80-00006699)</p> <p>The T-2INSERT kit can be installed inside a single power socket opening and includes:</p> <ul style="list-style-type: none"> 1 single cable pass-through insert 1 dual cable pass-through insert

4.3 Power Socket Options

Inner frames support installing one or more of the following power socket assemblies.

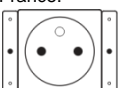

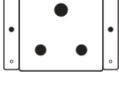
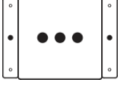

Note: The Brazilian power sockets are supplied as dual power sockets in a single power socket assembly (see table below).

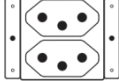
4.3.1 Single Power Socket Assemblies

Socket Type	Power Specs		
Universal: 	TS-1U (80-000899) 100-240V AC, 50/60Hz, 5A Maximum 5A per power outlet	Fully compatible with power plugs in the UK, India, Italy and Denmark, as well as with the 2-prong Europlug. Partially compatible (if the polarity is reversed) with plugs in China, Switzerland, Israel and the USA. The universal socket does not supply grounding to plugs in Central Europe and France and so you should order country specific sockets instead. Not compatible with South African plugs.	
USA: 	TS-1US (80-000999) 100-125V AC, 50/60Hz, 5A Maximum 5A per power outlet	UK 	TS-1UK (91-000022) 100-240V AC, 50/60Hz, 5A Maximum 5A per power outlet
Belgium and France: 	TS-1FR (80-001399) 100-240V AC, 50/60Hz, 5A Maximum 5A per power outlet	Israel: 	TS-1IL (80-001799) 100-240V AC, 50/60Hz, 5A Maximum 5A per power outlet
Germany and EU: 	TS-1DE (80-001299) 100-240V AC, 50/60Hz, 5A Maximum 5A per power outlet	South Africa 	TS-1ZA (80-001699) 100-240V AC, 50/60Hz, 5A Maximum 5A per power outlet
Italy: 	TS-1IT (80-001499) 100-240V AC, 50/60Hz, 5A Maximum 5A per power outlet	Australia: 	TS-1AU (80-001599) 100-240V AC, 50/60Hz, 5A Maximum 5A per power outlet

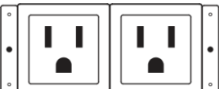
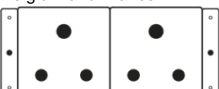
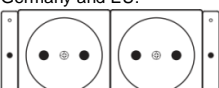
Socket Type	Power Specs	Socket Type	Power Specs
Switzerland 	TS-1CH (80-000027) 100-240V AC, 50/60Hz, 5A Maximum 5A per power outlet	Brazil 	TS-BR (80-000034) 100-240V AC, 50/60Hz, 5A Maximum 5A/2.5A per power outlet

4.3.2 Dual Power Socket Assemblies

Socket Type	Power Specs
Universal: 	TS-2U (80-001899) 100-240V AC, 50/60Hz, 5A Maximum 5A/2.5A per power outlet
USA: 	TS-2US (80-001999) 100-125V AC, 50/60Hz, 5A Maximum 5A/2.5A per power outlet
Belgium and France: 	TS-2FR (80-002299) 100-240V AC, 50/60Hz, 5A Maximum 5A/2.5A per power outlet
Germany and EU: 	TS-2DE (80-002199) 100-240V AC, 50/60Hz, 5A Maximum 5A/2.5A per power outlet
Italy 	TS-2IT (80-002399) 100-240V AC, 50/60Hz, 5A Maximum 5A/2.5A per power outlet
Switzerland 	TS-2CH (80-000026) 100-240V AC, 50/60Hz, 5A Maximum 5A/2.5A per power outlet
UK 	TS-2UK (91-000023) 100-240V AC, 50/60Hz, 5A Maximum 5A/2.5A per power outlet
Israel: 	TS-2IL (80-002699) 100-240V AC, 50/60Hz, 5A Maximum 5A/2.5A per power outlet

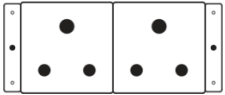
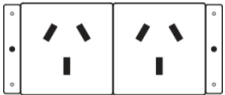
Socket Type	Power Specs
South Africa: 	TS-2ZA (80-002599) 100-240V AC, 50/60Hz, 5A Maximum 5A/2.5A per power outlet
Australia: 	TS-2AU (80-002499) 100-240V AC, 50/60Hz, 5A Maximum 5A/2.5A per power outlet

4.4 Power Cord Options

You can order any of the following power cords to use with a modular TBUS:

Power Cord Type	Description	P/N
6ft/110V (North America)	C-AC/US (110V)	91-000099
6ft/125V (Japan)	C-AC/JP (125V)	91-000699
6ft/220V (Europe)	C-AC/EU (220V)	91-000199
6ft/220V (Israel)	C-AC/IL (220V)	91-000999
6ft/250V (UK)	C-AC/UK (250V)	91-000299
6ft/250V (India)	C-AC/IN (250V)	91-001099
6ft/250V/10A (China)	C-AC/CN (250V)	91-001199
6ft/250V/10A (South Africa)	C-AC/ZA (250V)	91-001299

5 Installing the TBUS-3xl

To install the **TBUS-3xl** perform the following steps:

1. Assemble the inner frame (see [Section 5.1](#)).
2. Install the inner frame (see [Section 5.2](#)).
3. Cut an opening in the table (see [Section 5.3](#)).
4. Insert the unit through the opening and secure to the table (see [Section 5.4](#)).
5. Connect the cables (see [Section 5.5](#)).
6. Insert the cables via the 4-cable pass-through insert (see [Section 5.6](#)).
7. Insert the cables via a pass through insert (see [Section 5.7](#)).
8. Adjust the height of the inner frame (see [Section 5.8](#)).

5.1 Assembling the Inner Frame

The modules mounted on the inner frame can include single inserts and/or dual inserts as well as a power socket (in some models). This section describes how to assemble these modules.



Each module kit comes with detailed assembly instructions.

5.1.1 Mounting the Inserts

You can rearrange or remove any of the plates mounted on the inner frame and replace them with Kramer passive wall plates or connector modules for interfacing A/V type signals.

To mount a Kramer insert or connector module:

1. Unscrew the two screws that fasten the blank plate to the inner frame and remove the blank plate.
2. Place the required Kramer insert over the opening, insert the two screws to fix the Kramer insert in place, and tighten them.

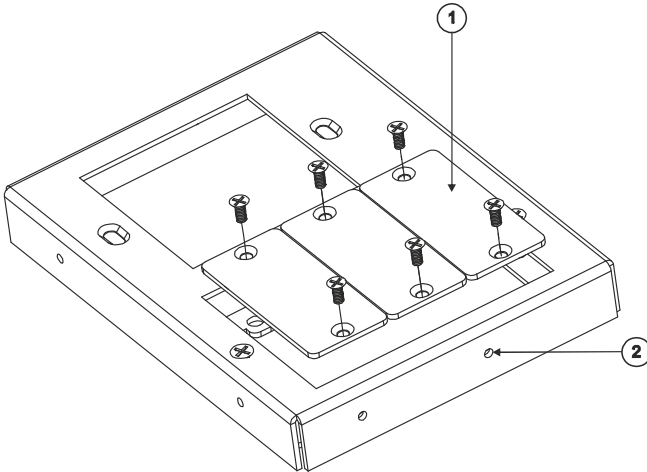

Figure 3: TBUS-3xl Inner Frame (P/N: 80-003099)

#	Feature	Function
1	Blank Plates	Three blank covers that can be replaced with wall plates as required
2	Adjustable Height Screw Holes	For adjusting the height of the Inner frame

5.1.2 Mounting the Power Socket Assemblies

To mount the power socket, place the power socket under the frame in its appropriate place and tighten with the two screws (supplied).



Power socket kits come with assembly instructions.

5.2 Installing the Inner Frame

To install the inner frame:

1. Place the inner frame inside the **TBUS-3xl** enclosure.
2. Set the required height using your fingers to bring the inner frame to the desired position, screw and tighten it in place using the height adjustment screws (supplied with the inner frame).



Inner frame kits come with assembly instructions.

5.3 Cutting an Opening in the Table

To cut an opening in the table:

1. Place the included cut out template (that is included with your **TBUS-3xl**) on the surface of the table exactly where you want to install the **TBUS-3xl**.
2. Attach the template to the table with the included screws (if using the cut out template).
3. Following the **inside** edge of the template, cut a hole in the table surface with a sabre or keyhole saw according to the dimensions shown in [Figure 4](#) (not to scale).



The thickness of the table should be 76.2mm / 3 inches or less.

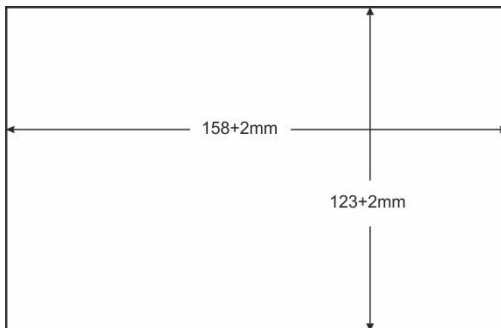

Figure 4: Cut out Dimensions

4. Unscrew and remove the template from the surface of the table and clean the table surface.

Take care not to damage the table.

If needed, you can download a full-scale template from our Web site.



Kramer Electronics is not responsible for any damage caused to the table.

5.4 Inserting the TBUS-3xl through the Cut Out Opening

To install **TBUS-3xl** in the opening:

1. Remove the protective rubber guard from around the outer rim of the **TBUS-3xl** housing. **Beware of the sharp edge!**
2. Carefully insert the unit into the prepared opening (see [Figure 5](#)).
3. Take the support brackets under the table and place them into the support bracket grooves on both sides of the unit (see [Figure 2](#), item 7).
4. Verify proper alignment of the unit before tightening the mounting screws.
5. Tighten both mounting butterfly screws upward until they reach the table surface (from underneath). Tighten firmly (see [Figure 5](#)).
6. Tighten the locking butterfly screws downward until tight against the mounting bracket.

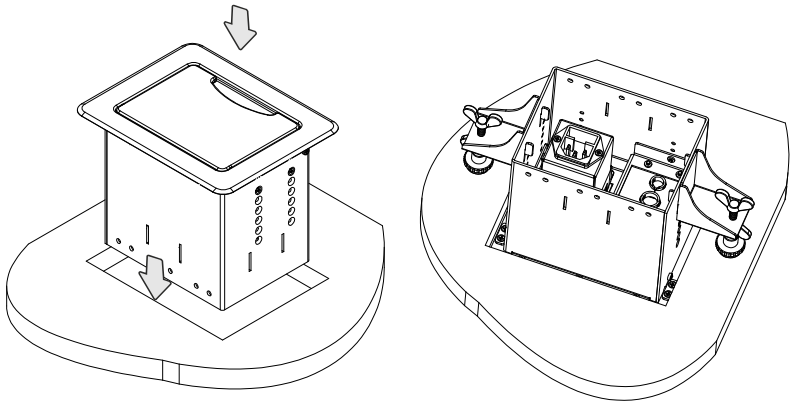

Figure 5: Inserting TBUS-3xl into the Prepared Opening

5.5 Connecting the Cables

When replacing blank inserts with connector inserts (for example, VGA, audio, HDMI and so on):

1. Insert the cables to their appropriate connectors from underneath.
2. Secure the cables to the tie holes on the **TBUS-3xl**.
Do not secure the cables too tightly or too loosely. Leave a small amount of slack.

After the **TBUS-3xl** is connected to mains power and the proper cables, it is ready for use.

5.6 Inserting Cables via the 4-cable Pass-through Insert

To insert the cables via the 4-cable pass-through insert (for example, to pass cables from beneath the table to several laptops) do the following:

1. Remove the four screws attaching the split pass-through bracket.
2. Remove the split grommet(s).
The split grommets are not shown in [Figure 6](#)
3. Insert the cable(s) through the rectangular opening.
4. Open the split grommet slightly and insert the required cables.
5. Place the split bracket around the grommet and position this assembly over the inner frame.
6. Place the four screws appropriately and tighten the split bracket together with the grommet and inserted cables to the inner frame.
7. Insert the self-locking ties through the tie holes to secure the cables to the inside walls of the enclosure.

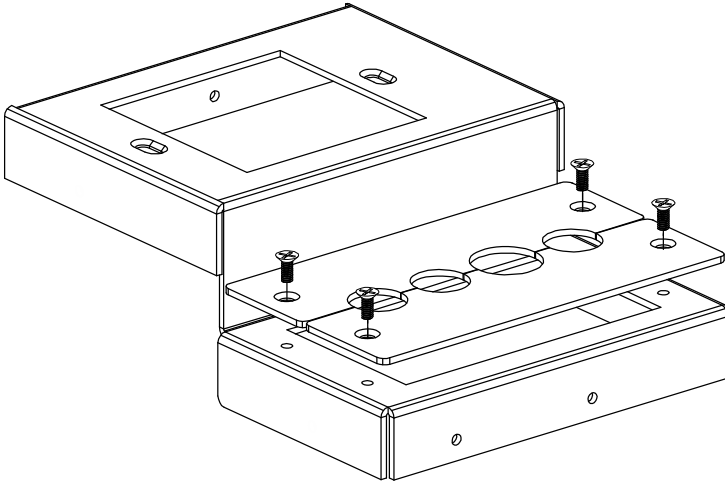

Figure 6: 4-cable Pass-through Insert (P/N: 80-003199)

5.7 Inserting the Pass-through Cables

When replacing a blank insert with the pass-through insert, for example, to connect a laptop, do the following:

1. Remove the two screws attaching the split pass-through bracket.
2. Remove the split grommet.
3. Insert the cable through the rectangular opening.
4. Open the split grommet slightly and insert the required cables.
5. Place the split bracket around the grommet and position this assembly over the Inner Frame.
6. Place the two screws appropriately and tighten the split bracket together with the grommet and inserted cables to the inner frame.
7. Insert the self-locking ties through the tie holes to secure the cables to the inside walls of the enclosure.

5.8 Adjusting the Height of the Inner frame

If needed, you can adjust the inner frame height to accommodate large or bulky cables. To adjust, perform the following:

1. Remove the height adjustment screws, while supporting the surface from underneath with your fingers.
2. Raise or lower the inner frame to the required height, insert the screws, and tighten them in place.

6 Using the TBUS-3xl

Once the **TBUS-3xl** is installed, you can easily customize it to suit your own requirements by plugging in the required A/V equipment, as illustrated in the example in [Figure 7](#).

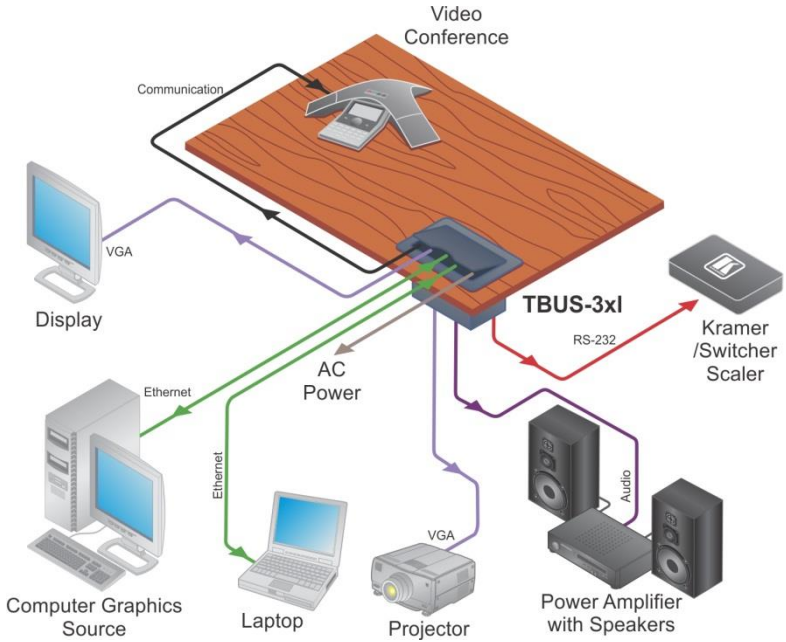

Figure 7: TBUS-3xl Boardroom Installation

7 Technical Specifications of the Assembled TBUS-3xl

POWER SOURCE (AC power limits):	Power Socket Assemblies	
	Universal	100-240V AC, 50/60Hz, 5A Maximum 5A per power outlet
	<p>Fully compatible with power plugs in the UK, India, Italy and Denmark, as well as with the 2-prong Europlug.</p> <p>Partially compatible (if the polarity is reversed) with plugs in China, Switzerland, Israel and the USA. The universal socket does not supply grounding to plugs in Central Europe and France (you should order country specific sockets instead).</p> <p>Not compatible with South African plugs.</p>	
	USA	100-240V AC, 50/60Hz, 5A Maximum 5A per power outlet
	Germany and EU	100-240V AC, 50/60Hz, 5A Maximum 5A per power outlet
	Belgium and France	100-240V AC, 50/60Hz, 5A Maximum 5A per power outlet
	Italy	100-240V AC, 50/60Hz, 5A Maximum 5A per power outlet
	Australia	100-240V AC, 50/60Hz, 5A Maximum 5A per power outlet
	Israel	220V AC, 50/60Hz, 5A Maximum 5A per power outlet
	South Africa	220V AC, 50/60Hz, 5A Maximum 5A per power outlet
FUSE RATING:	T 6.3A 250V	
OPERATING TEMPERATURE RANGE:	+5 to +45 Deg. Centigrade	
OPERATING HUMIDITY RANGE:	10 to 90% RHL, non-condensing	
STORAGE TEMPERATURE RANGE:	-20 to +70Deg. C.	
STORAGE HUMIDITY RANGE:	5 to 95% RHL, non-condensing	
DIMENSIONS:	Top plate: 176mm x 140.4mm (6.9" x 5.5") W, D Enclosure: 136mm x 102mm x 130mm (5.4" x 4.0" x 5.1") W, D, H	
WEIGHT:	TBUS-3: 0.8kg (1.76lbs) approx. Table clamps: 0.26kg (0.57lbs) Template: 0.12kg (0.27lbs)	
ACCESSORIES:	Power cord, six self-locking ties, template, template screws	
OPTIONS:	Inner frames, passive wall plates and interfaces, power socket kits, power cord	
Specifications are subject to change without notice at http://www.kramerav.com		

LIMITED WARRANTY

The warranty obligations of Kramer Electronics for this product are limited to the terms set forth below:

What is Covered

This limited warranty covers defects in materials and workmanship in this product.

What is Not Covered

This limited warranty does not cover any damage, deterioration or malfunction resulting from any alteration, modification, improper or unreasonable use or maintenance, misuse, abuse, accident, neglect, exposure to excess moisture, fire, improper packing and shipping (such claims must be presented to the carrier), lightning, power surges, or other acts of nature. This limited warranty does not cover any damage, deterioration or malfunction resulting from the installation or removal of this product from any installation, any unauthorized tampering with this product, any repairs attempted by a anyone unauthorized by Kramer Electronics to make such repairs, or any other cause which does not relate directly to a defect in materials and/or workmanship of this product. This limited warranty does not cover cartons, equipment enclosures, cables or accessories used in conjunction with this product.

Without limiting any other exclusion herein, Kramer Electronics does not warrant that the product covered hereby, including, without limitation, the technology and/or integrated circuit(s) included in the product, will not become obsolete or that such items are or will remain compatible with any other product or technology with which the product may be used.

How Long Does this Coverage Last

Seven years as of this printing; please check our Web site for the most current and accurate warranty information.

Who is Covered

Only the original purchaser of this product is covered under this limited warranty. This limited warranty is not transferable to subsequent purchasers or owners of this product.

What Kramer Electronics will do

Kramer Electronics will, at its sole option, provide one of the following three remedies to whatever extent it shall deem necessary to satisfy a proper claim under this limited warranty:

1. Elect to repair or facilitate the repair of any defective parts within a reasonable period of time, free of any charge for the necessary parts and labor to complete the repair and restore this product to its proper operating condition. Kramer Electronics will also pay the shipping costs necessary to return this product once the repair is complete.
2. Replace this product with a direct replacement or with a similar product deemed by Kramer Electronics to perform substantially the same function as the original product.
3. Issue a refund of the original purchase price less depreciation to be determined based on the age of the product at the time remedy is sought under this limited warranty.

What Kramer Electronics will not do Under This Limited Warranty

If this product is returned to Kramer Electronics or the authorized dealer from which it was purchased or any other party authorized to repair Kramer Electronics products, this product must be insured during shipment, with the insurance and shipping charges prepaid by you. If this product is returned uninsured, you assume all risks of loss or damage during shipment. Kramer Electronics will not be responsible for any costs related to the removal or re-installation of this product from or into any installation. Kramer Electronics will not be responsible for any costs related to any setting up this product, any adjustment of user controls or any programming required for a specific installation of this product.

How to Obtain a Remedy under this Limited Warranty

To obtain a remedy under this limited warranty, you must contact either the authorized Kramer Electronics reseller from whom you purchased this product or the Kramer Electronics office nearest you. For a list of authorized Kramer Electronics resellers and/or Kramer Electronics authorized service providers, please visit our web site at www.kramerelectronics.com or contact the Kramer Electronics office nearest you.

In order to pursue any remedy under this limited warranty, you must possess an original, dated receipt as proof of purchase from an authorized Kramer Electronics reseller. If this product is returned under this limited warranty, a return authorization number, obtained from Kramer Electronics, will be required. You may also be directed to an authorized reseller or a person authorized by Kramer Electronics to repair the product.

If it is decided that this product should be returned directly to Kramer Electronics, this product should be properly packed, preferably in the original carton, for shipping. Cartons not bearing a return authorization number will be refused.

Limitation on Liability

THE MAXIMUM LIABILITY OF KRAMER ELECTRONICS UNDER THIS LIMITED WARRANTY SHALL NOT EXCEED THE ACTUAL PURCHASE PRICE PAID FOR THE PRODUCT. TO THE MAXIMUM EXTENT PERMITTED BY LAW, KRAMER ELECTRONICS IS NOT RESPONSIBLE FOR DIRECT, SPECIAL, INCIDENTAL OR CONSEQUENTIAL DAMAGES RESULTING FROM ANY BREACH OF WARRANTY OR CONDITION, OR UNDER ANY OTHER LEGAL THEORY. Some countries, districts or states do not allow the exclusion or limitation of relief, special, incidental, consequential or indirect damages, or the limitation of liability to specified amounts, so the above limitations or exclusions may not apply to you.

Exclusive Remedy

TO THE MAXIMUM EXTENT PERMITTED BY LAW, THIS LIMITED WARRANTY AND THE REMEDIES SET FORTH ABOVE ARE EXCLUSIVE AND IN LIEU OF ALL OTHER WARRANTIES, REMEDIES AND CONDITIONS, WHETHER ORAL OR WRITTEN, EXPRESS OR IMPLIED. TO THE MAXIMUM EXTENT PERMITTED BY LAW, KRAMER ELECTRONICS SPECIFICALLY DISCLAIMS ANY AND ALL IMPLIED WARRANTIES, INCLUDING, WITHOUT LIMITATION, WARRANTIES OF MERCHANTABILITY AND FITNESS FOR A PARTICULAR PURPOSE. IF KRAMER ELECTRONICS CANNOT LAWFULLY DISCLAIM OR EXCLUDE IMPLIED WARRANTIES UNDER APPLICABLE LAW, THEN ALL IMPLIED WARRANTIES COVERING THIS PRODUCT, INCLUDING WARRANTIES OF MERCHANTABILITY AND FITNESS FOR A PARTICULAR PURPOSE, SHALL APPLY TO THIS PRODUCT AS PROVIDED UNDER APPLICABLE LAW.

IF ANY PRODUCT TO WHICH THIS LIMITED WARRANTY APPLIES IS A "CONSUMER PRODUCT" UNDER THE MAGNUSON-MOSS WARRANTY ACT (15 U.S.C.A. §2301, ET SEQ.) OR OTHER APPLICABLE LAW, THE FOREGOING DISCLAIMER OF IMPLIED WARRANTIES SHALL NOT APPLY TO YOU, AND ALL IMPLIED WARRANTIES ON THIS PRODUCT, INCLUDING WARRANTIES OF MERCHANTABILITY AND FITNESS FOR THE PARTICULAR PURPOSE, SHALL APPLY AS PROVIDED UNDER APPLICABLE LAW.

Other Conditions

This limited warranty gives you specific legal rights, and you may have other rights which vary from country to country or state to state.

This limited warranty is void if (i) the label bearing the serial number of this product has been removed or defaced, (ii) the product is not distributed by Kramer Electronics or (iii) this product is not purchased from an authorized Kramer Electronics reseller. If you are unsure whether a reseller is an authorized Kramer Electronics reseller, please visit our Web site at www.kramerelectronics.com or contact a Kramer Electronics office from the list at the end of this document.

Your rights under this limited warranty are not diminished if you do not complete and return the product registration form or complete and submit the online product registration form. Kramer Electronics thanks you for purchasing a Kramer Electronics product. We hope it will give you years of satisfaction.



For the latest information on our products and a list of Kramer distributors, visit our Web site where updates to this user manual may be found.

We welcome your questions, comments, and feedback.

Web site: www.krameray.com

E-mail: info@kramerel.com

CE



SAFETY WARNING

Disconnect the unit from the power supply before opening and servicing



P/N: 2900-300062



Rev: 3