



Complete Manual for

# CeilingMIC and EasyIP CeilingMIC D

Overhead Microphones

Document 411-0033-30 Rev F  
September 2020

# Contents

Overview .....	1
About this Manual .....	1
Features .....	1
Product Compatibility .....	1
What's in the Box .....	2
A Quick Look at the Microphone System .....	3
Installation .....	4
Preparing for a Successful Audio Installation .....	4
Tools You Will Need .....	4
Safety Information .....	4
Don't Void Your Warranty! .....	5
Cabling Notes .....	5
Preparing the Ceiling Box .....	6
Preparing the Ceiling .....	7
Installing the Ceiling Box .....	7
Connecting the Microphone Body .....	8
Basic Connections – CeilingMIC .....	8
Basic Connections – EasyIP CeilingMIC D .....	10
Administration and Operation – EasyMic Microphones .....	11
Working with EasyMic Microphones .....	11
Updating EasyMic Microphones from ConferenceSHOT AV or AV Bridge MATRIX PRO .....	12
Updating EasyMic products from EasyUSB Mixer/Amp .....	14
Administration and Operation – EasyIP Microphones .....	17
About Dante Technology and Devices .....	17
Locating and Pairing to Dante Devices .....	18
Using More than Two EasyIP Microphones with a Vaddio Host Device .....	20
About Channels and Flows .....	20
Creating a Multicast Flow .....	21
Combining Microphone Channels into Flows .....	22
Working with EasyIP Microphones .....	24
About the Vaddio Dante Interface Application .....	24
Fine-Tuning EasyIP Microphone Performance .....	25
Installing a Firmware Update for an EasyIP Microphone .....	27
Specifications .....	28
Troubleshooting .....	29
Use, Storage, and Care .....	29
Compliance and Conformity Statements .....	30
FCC Part 15 Compliance .....	30
ICES-003 Compliance .....	30
European Compliance .....	31

Photo Credits .....	32
Index .....	33

## Overview

This manual covers:

- **CeilingMIC** Conference Room Microphone (worldwide) – 999-85100-000 (white); 999-85150-000 (black)
- **EasyIP CeilingMIC D** Overhead Microphone with Dante Networked Audio (worldwide) – 999-85810-000 (white); 999-85820-000 (black)

## About this Manual

Information in this manual includes:

- Unpacking and installation
- Operation
- Updating firmware
- Specifications
- Troubleshooting
- Warranty and compliance/conformity information

## Features

The CeilingMIC offers the great features and performance you expect from the EasyMic family of microphones.

The EasyIP CeilingMIC D provides the same capabilities plus Dante connectivity.

- Three-element design with improved geometry for 360° coverage and better audio pick-up
- Built-in digital signal processor (DSP)
- Easy access to the microphone cable connector
- Designed for customizable ceiling drop cable length
- EasyIP CeilingMIC D only: Dante networked audio
- CeilingMIC only: Vaddio EasyMic connectivity

## Product Compatibility

The **CeilingMIC** conference room microphone maintains compatibility with Vaddio products that provide EasyMic connectivity. It is not compatible with Dante environments.

The **EasyIP CeilingMIC D** network-connected overhead microphone is compatible with Dante environments. It does not offer EasyMic connectivity.



## What's in the Box

Make sure you received all the items you expected.

**CeilingMIC conference room microphone (worldwide) – 999-85100-000 (white); 999-85150-000 (black)**

- In-ceiling interface box
- Microphone body and strain-relief boot (white or black)
- Tile brace
- Trim plates, qty. 2, with mounting hardware (white or black)
- Drop-down cable (white or black)
- Small zip-tie
- Strain relief clamp
- Split grommet

**EasyIP CeilingMIC D network-connected overhead microphone (worldwide) – 999-85810-000 (white); 999-85820-000 (black)**

- In-ceiling interface box
- Microphone body and strain-relief boot (white or black)
- Tile brace
- Trim plates, qty. 2, with mounting hardware (white or black)
- Drop-down cable (white or black)
- Small zip-tie
- Strain relief clamp
- Split grommet

Contact Vaddio Technical Support if you did not receive all the items listed.

Find full product documentation on the applicable product page(s) at [legrandav.com](http://legrandav.com).

## A Quick Look at the Microphone System

### Interface box

- Provides AEC reference from far end and applies it to each microphone element individually
- New design emphasizes simplicity and ease of connection
- CeilingMIC: Up to 100 ft. cable distance from the interface box to the connected device
- EasyIP CeilingMIC D: Single connection from the interface box to the network

### Trim plates

- White or black, to match the microphone body
- Two-piece design can be installed after the rest of the installation is complete

### Drop-down cable

- Matches the trim ring and microphone body
- Up to 15 ft. (4.6 m) drop-down cable length supported

### Strain relief boot

- Securely grips the drop cable to prevent tension at the connector
- Split design and flexible material for easy installation
- Accommodates standard category cable; installers can build cable to length
- Clean lines for visual appeal

### Microphone body

- Three-element design with improved geometry for 360° coverage with better audio pick-up
- Each microphone element features integrated echo cancellation and Digital Signal Processing (DSP), including equalization, filtering and automatic gain control (AGC)
- Easy access to the cable connector in the microphone
- Cloth-wrapped design

### **Note**

Contact Vaddio Technical Support if your installation requires a drop-down cable longer than 15 ft. (4.6 m).



## Installation

This section covers:

- Safety information
- Tips for a successful audio installation
- Tools you will need
- Cabling notes
- Installing the CeilingMIC
- Connection diagrams

## Preparing for a Successful Audio Installation

Here are a few tips for avoiding common audio problems.

- The effective range for each Vaddio conference room microphone is about 12 ft. (3.7 m) under most circumstances. Be sure the room design includes enough microphones to provide adequate coverage.
- Because of its geometry, the overhead microphone is less sensitive in a small area directly below it. In a small to medium corporate conference room, it may make sense to suspend the microphone(s) above the centerline of the conference table.
- To prevent audio feedback, keep microphones at least 4 ft. (1.2 m) from speakers. More separation is better.
- Place microphones closer to the people talking than to the room's speakers. This helps maintain quality echo cancellation.
- Do not route microphone cables across or beside fluorescent light fixtures. Electrical interference from the ballasts may degrade the audio signal.
- Mount the overhead microphone away from air vents, to avoid picking up the sounds of the HVAC system.

## Tools You Will Need

To install the overhead microphone, you will need:

- Hole saw for the appropriate type of ceiling
- #2 Phillips screwdriver
- Wire cutters
- Tape measure
- Ladder or lift
- Appropriate personal protective equipment

## Safety Information

### **Warning**

*Follow standard safety practices when using ladders or lifts. Failure to do so can result in injury or death.*



### **Note**

*All above-ceiling work must conform to local building codes and should be performed by qualified personnel.*

## Don't Void Your Warranty!

### **Caution**

*This product is for indoor use. Do not install it outdoors or in a humid environment without the appropriate protective enclosure. Do not allow it to come into contact with any liquid.*

*Do not install or operate this product if it has been dropped, damaged, or exposed to liquids. If any of these things happen, return it to Vaddio for safety and functional testing.*

## Cabling Notes

Ceiling microphones are shipped with one Cat-5e cable to connect to the interface box.

### **Caution**

*When building cables for Vaddio products, do not use pass-through RJ-45 connectors. If they are crimped incorrectly, they can cause intermittent connections and degrade signal quality. Incorrectly crimped pass-through connectors can also damage the connectors on the product, which will void your warranty.*

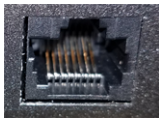

**Intact** – will make reliable contact with cable connector

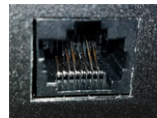

**Damaged** – Bent contact fingers will NOT make reliable contact with cable connector

Use Cat-5e or better cable. We recommend using high-quality connectors and a high-quality crimping tool. We recommend shielded cabling if the cables will be coiled, run tightly with other cables, or routed near sources of electromagnetic interference such as power lines or fluorescent light fixtures.

### **Caution**

*Check your cables. Connecting a cable to the wrong port or using the wrong pin-out can result in equipment damage and will void the warranty.*

### **Pro Tip**

*Label all cables at both ends.*



## Preparing the Ceiling Box

1. Remove the cover from the ceiling box.

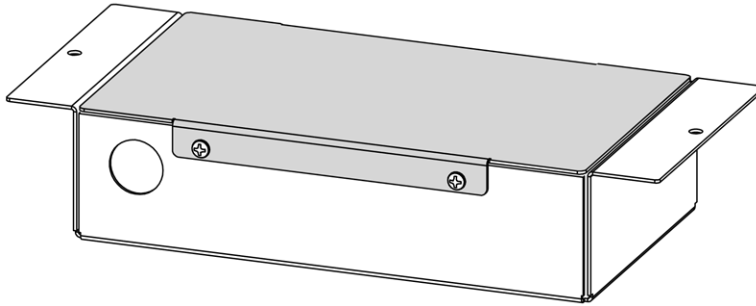

2. Determine the desired length of the drop cable, from the ceiling to the top of the microphone body (not the top of the strain relief boot). Be sure this leaves enough cable inside the ceiling box to avoid placing tension on the connector.

**Note**

*If desired, you can use a Cat-5e cable made to the desired length for the microphone drop-down cable. The cable may be up to 15 ft. (4.6 m); contact Vaddio Technical Support if your installation requires a longer drop cable.*

3. Thread the drop cable through the opening in the floor of the box.
4. Snap the strain relief grommet onto the drop cable at the desired cable length, and press it into the opening in the floor of the box.
5. Connect the drop cable to the port labeled IN FROM MIC.
6. If there is excess cable above the grommet, thread a zip tie through the tie loop in the side of the box and secure the cable.

**Note**

*The photo shows the ceiling box for a CeilingMIC. The EasyIP CeilingMIC D has a larger circuit board.*



## Preparing the Ceiling

### **Warning**

*Follow standard safety practices when using ladders or lifts. Failure to do so can result in injury or death. We like you, we don't want you to be injured or killed, and we hope you understand the gravity of the situation.*

### **If installing in a hard ceiling:**

Using the tile brace as a template, make a hole in the ceiling where the microphone will be mounted.

### **If installing in a suspended tile ceiling:**

1. Remove the ceiling tile where the microphone will be mounted, and make a hole in the ceiling tile using the tile brace as a template.
2. Reinstall the ceiling tile and position the tile brace.

### **Note**

*Because the microphone assembly weighs very little, the tile brace does not need to be physically attached to the tile support grid unless this is required by local building codes.*

## Installing the Ceiling Box

Working above the ceiling:

1. CeilingMIC: Route a Cat-5e (or better) cable from the ceiling box to the mixer or other audio device. The cable may be up to 100 ft. (30 m.) long.  
EasyIP CeilingMIC D: Route a Cat-5e (or better) cable from the ceiling box to the PoE+ switch. The cable may be up to 100 ft. (30 m.) long.
2. Thread the cable through the opening in the side of the ceiling box.
3. Install the split grommet in the opening in the side of the ceiling box to keep the cable from chafing.
4. Connect the cable to the port labeled OUT TO MIXER.
5. Reinstall the cover on the ceiling box.
6. Thread the drop cable through the opening in the tile brace and ceiling, and place the ceiling box flat.

## Connecting the Microphone Body

Working below the ceiling:

1. Connect the drop cable to the port in the microphone body.

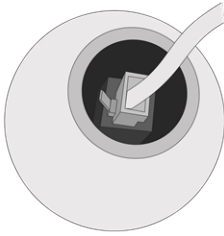

2. Fit the strain relief boot over the drop cable.
3. Fit the strain relief boot into place in the microphone body.
4. Making sure the countersinks face outward, slide both the slotted trim plates over the cable, with the slots on opposite sides. Use the 3/4 inch flat head screws to secure the trim plates to the threaded posts on the bottom of the interface box.

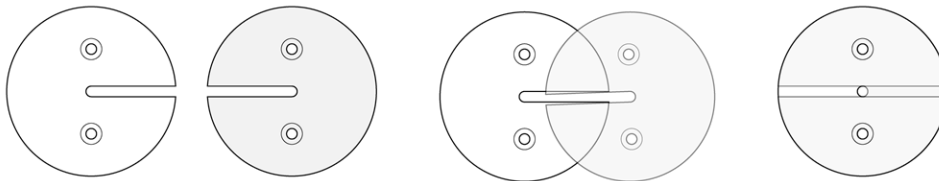

(Illustration shaded for clarity)

Contact Vaddio Technical Support if you have questions or encounter any problems. Phone 800.572.2011 / +1.763.971.4400, email [av.vaddio.support@legrand.com](mailto:av.vaddio.support@legrand.com).

## Basic Connections – CeilingMIC

This is a simple installation for a small conference room, using the CeilingMIC with a ConferenceSHOT AV system. In this installation, the CeilingMIC connects to a ConferenceSHOT AV camera with speaker. The camera connects to a computer over a USB 3 connection, making audio and video available to soft conferencing applications.

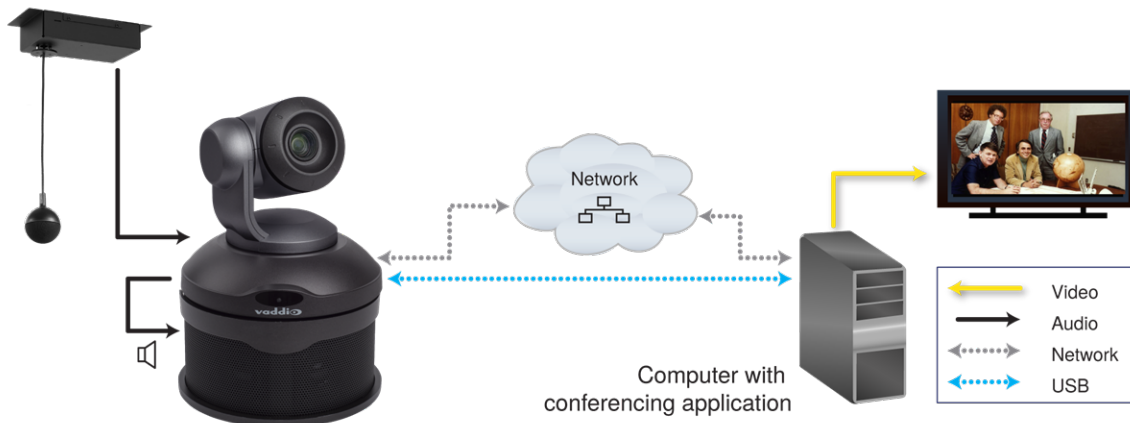

This installation is for a larger room, using an AV Bridge MATRIX PRO to manage the room audio and video. The four CeilingMIC microphones connect directly to EasyMic ports on the AV Bridge MATRIX PRO. The speaker(s) require an amplifier, as shown by the amplifier symbol in the diagram. This system can include multiple cameras.

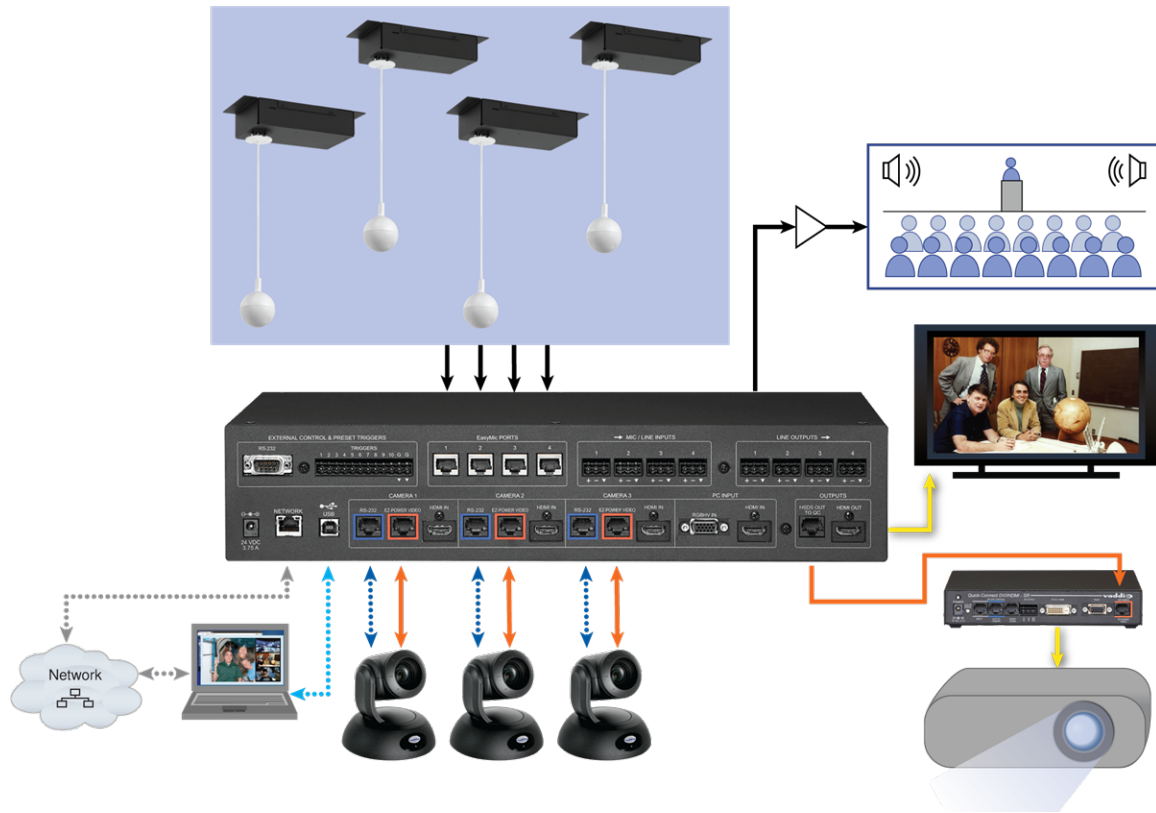

## Basic Connections – EasyIP CeilingMIC D

This is a simple installation for a medium to large conference room, using the EasyIP CeilingMIC D with an EasyIP Mixer. In this installation, the EasyIP CeilingMIC D microphones pair to an EasyIP Mixer over the network. The EasyIP Mixer also manages speakers and video, and originates a USB 3 stream, making audio and video available to soft conferencing applications.

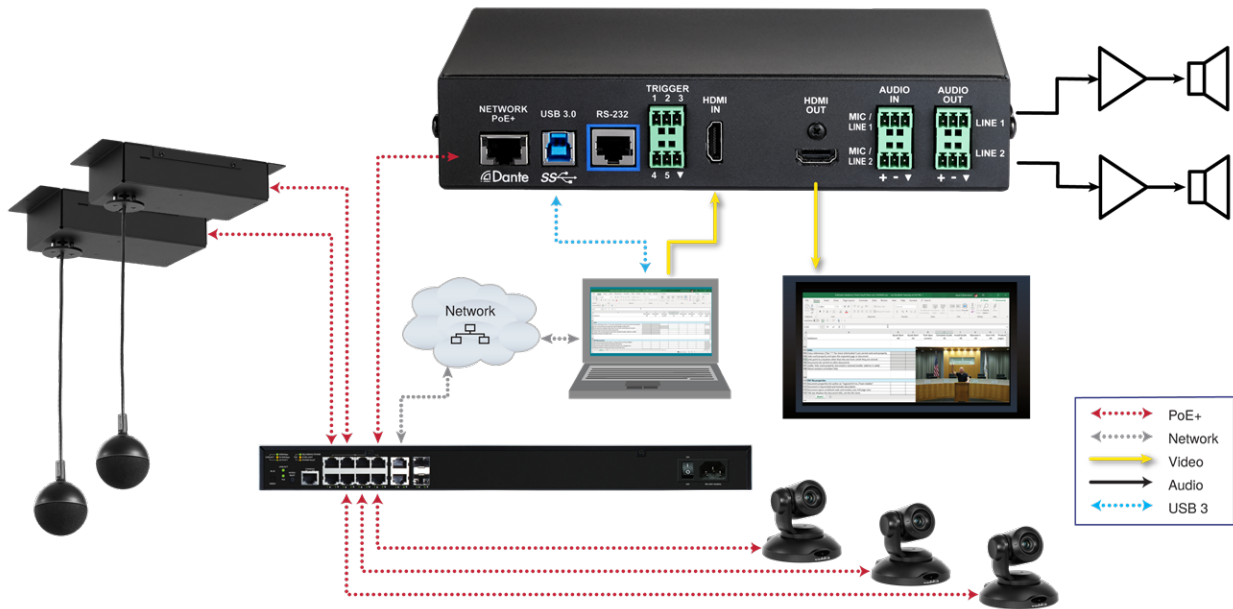

EasyIP CeilingMIC D microphones can also be used with other devices that support Dante connectivity.

### Note

Because EasyIP CeilingMIC D microphones are not directly connected to the device that manages them (an EasyIP Mixer in the diagram above), they must be paired to the device in order to operate.

To work with EasyIP CeilingMIC D and other Dante devices, you will need to download and install the free Dante Controller application from Audinate Pty. Ltd.: [www.audinate.com/products/software/dante-controller](http://www.audinate.com/products/software/dante-controller)

Things to know about Dante Controller:

- Dante Controller does not work over Wi-Fi or across subnets. Your computer must be on the same subnet as the Dante devices you need to work with.
- Device names and IP addresses shown in Dante Controller do not match the corresponding information shown in devices' web interfaces.

Audinate provides information, training, and documentation for Dante technology on their website.

## Administration and Operation – EasyMic Microphones

CeilingMIC microphones do not require any configuration when you connect them to Vaddio equipment. Microphones may occasionally require firmware updates, and you may wish to adjust them. For CeilingMIC microphones, you can do both through the host device's web interface.

### Working with EasyMic Microphones

This chapter is specific to the CeilingMIC. For information about the EasyIP CeilingMIC D with Dante networked audio, see [Administration and Operation – EasyIP Microphones](#).

When a microphone of the EasyMic family is connected to a compatible Vaddio device, you can manage it from that device's web interface. The managing device provides controls for muting/unmuting and for adjusting the microphone's performance, as shown in the screen shots below. In some cases the device may need to be updated to the latest firmware to work properly with the microphone.

The indicator light in the body of the CeilingMIC turns on when the microphone is muted.

Example: Managing a CeilingMIC or TableMIC from a HuddleSHOT camera

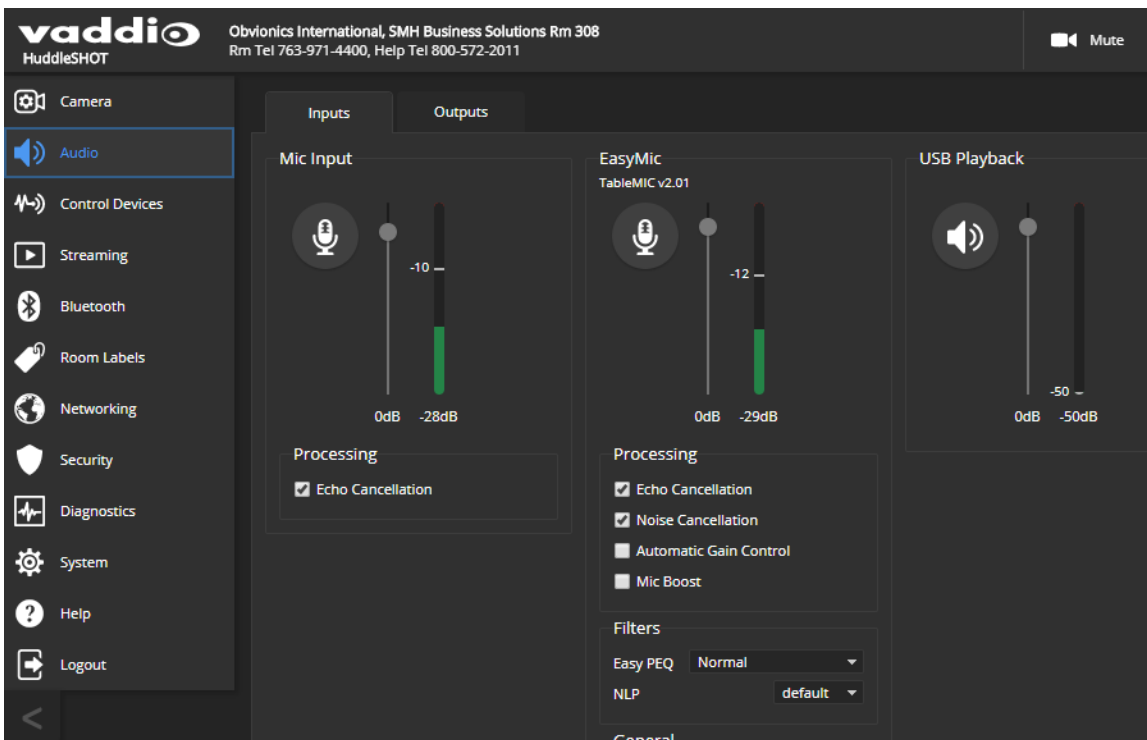

CeilingMIC microphones are updated via the equipment to which they are connected. The procedure varies, depending on the host product.

When you update the microphone firmware, you may also need to update the firmware of the other equipment in the room.

## Updating EasyMic Microphones from ConferenceSHOT AV or AV Bridge MATRIX PRO

Only one microphone at a time can be updated.

### Set everything up:

1. Go to the microphone's product page on the Vaddio website and download the update file identified as the web firmware update. The filename ends in .p7m.
2. Open a browser and enter the host device's IP address to access its web interface.
  - o If the microphone is connected to a ConferenceSHOT AV, point the remote at the camera and press the Data Screen button. The camera's IP address is overlaid on the video outputs.
  - o If the microphone is connected to an AV Bridge MATRIX PRO, use the knob on the front panel to dial to the Network menu, and press the Select button. The front panel display shows the encoder's IP address.

You may need to type `http://` or `https://` (with no space) before the IP address so the browser does not treat the IP address as a search query.

3. Log in as **admin**.

The web interface may differ somewhat from the screen shots in this procedure.

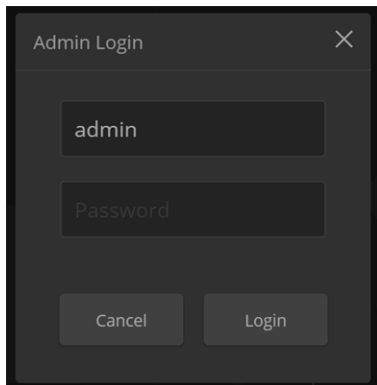
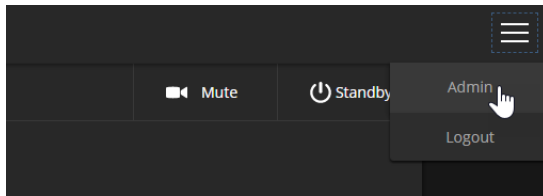

**Specify the microphone to update:**

1. Navigate to the host device's System page and select the Peripherals or Microphones tab.

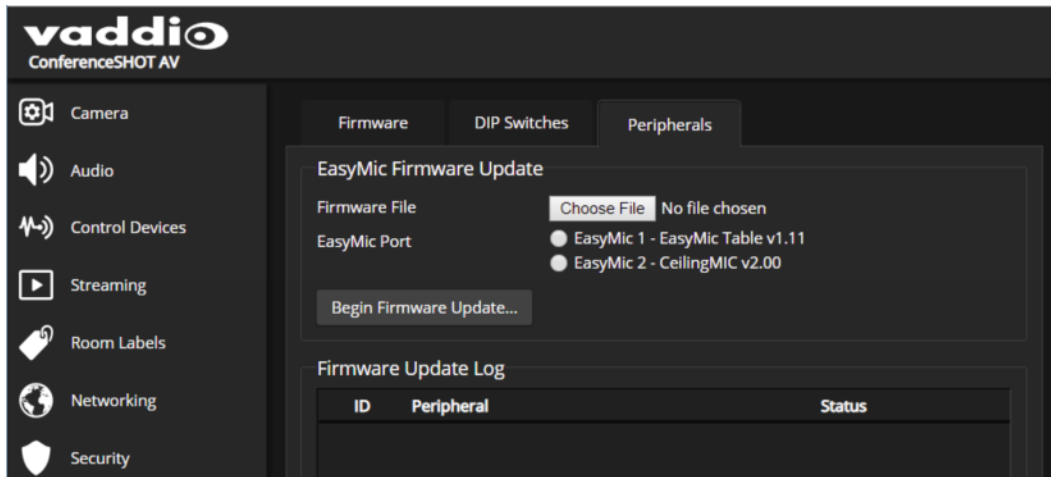

2. Select the port connection for the microphone to be updated.

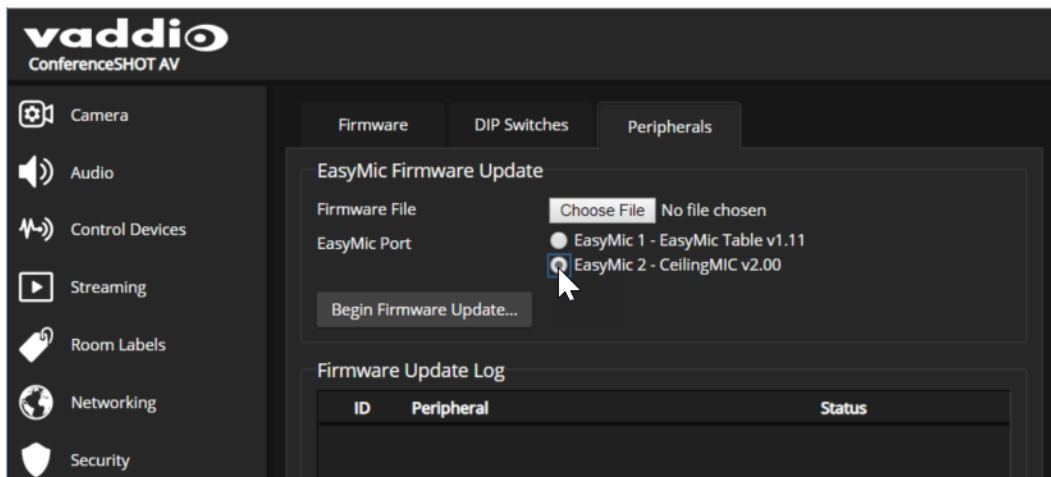



### Install the update:

1. Select Choose File. Then browse to the update file that you downloaded, and select it.
2. Select Begin Firmware Update.
3. READ the information in the Confirm dialog box and be sure you understand it.

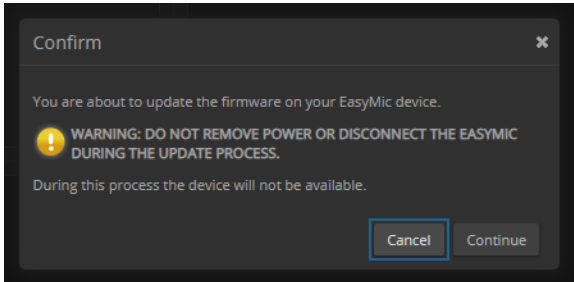

4. When you are ready to start the update, select Continue. The Firmware Update Log pane displays log messages during the update, and displays a success message when the microphone is updated and ready to use.

Repeat the process if you need to update another microphone.

## Updating EasyMic products from EasyUSB Mixer/Amp

You can only update one microphone at a time.

### Download the files you need:

1. Go to the microphone's product page on the Vaddio website and download the update file identified as the serial firmware update. The filename ends in .ldr.
2. Download the current version of the Vaddio Loader from [support.vaddio.com](http://support.vaddio.com) or the Vaddio resources page at [https://www.legrandav.com/en/tools\\_and\\_training/tools/vaddio\\_tools](https://www.legrandav.com/en/tools_and_training/tools/vaddio_tools).

### Connect to a computer:

Connect the EasyUSB Mixer/Amp to a PC as follows:

- Cat-5 cable from the EasyUSB Mixer/Amp's RS-232 port to the EZ Camera RS-232 Control Adapter
  - EZ Camera RS-232 Control Adapter to the PC's serial port, if it has one
- OR
- USB to 9-pin adapter cable from the EZ Camera RS-232 Control Adapter to the PC (shown)

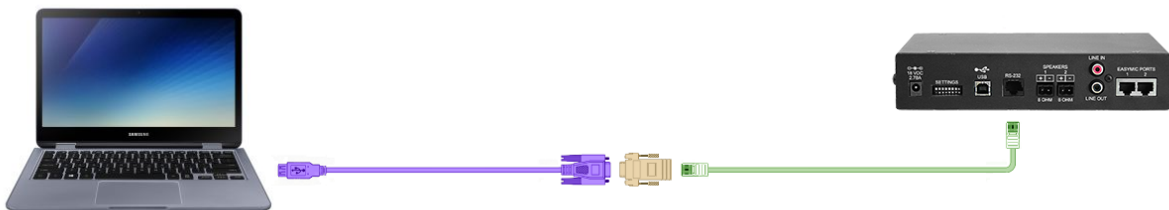

(The cable colors in this diagram do not represent anything. We just liked the idea of cables in fun colors.)

**Check communication using Vaddio Loader:**

1. On the computer, launch Vaddio Loader.
2. Specify the COM port connected to the EasyUSB Mixer/Amp, if prompted to do so.
3. Under Product Type, select Audio. This populates the product list in the box above the Product Type selection.
4. From the product list, select EasyUSB Mixer/Amp.

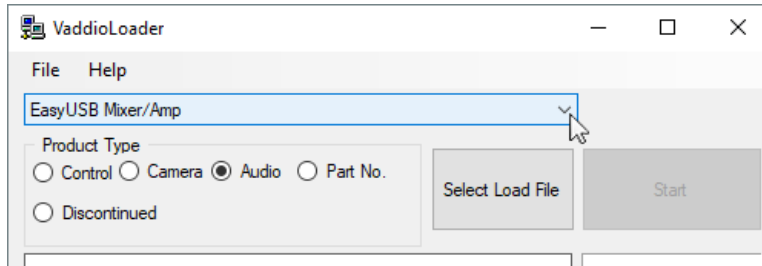

5. From the File menu, select Serial Commands. A new window opens.

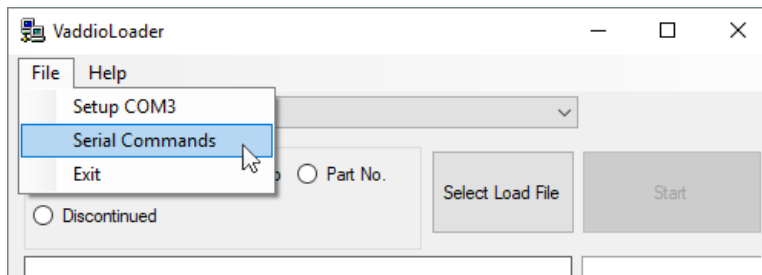

6. In the Command box, enter a question mark. Then select Send. The EasyUSB Mixer/Amp returns its current firmware version and a list of valid commands. This tells you that the device is connected correctly and that you have selected the COM port to which it is connected. If your query times out, returns no response, or returns a different response than expected, contact Vaddio Technical Support to troubleshoot before proceeding.

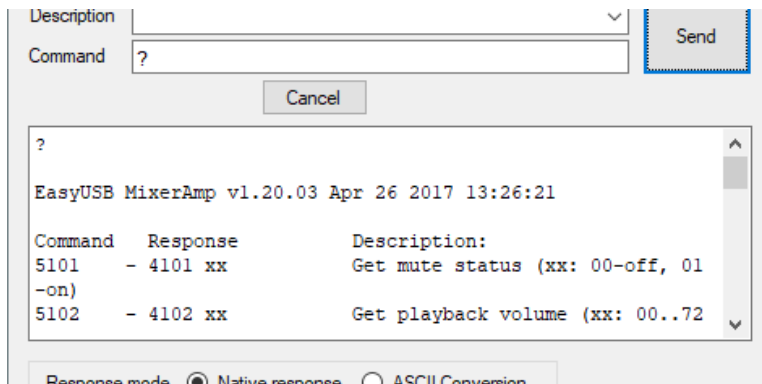

7. To confirm communication to the connected microphone and verify that it has not yet been updated to the latest version, send a version inquiry command to the appropriate EasyMic port:  
 EasyMic port 1: Enter the command 5202 00 and select Send.  
 EasyMic Port 2: Enter the command 5202 01 and select Send.  
 The microphone responds with 4202 followed by a two-digit model identifier and a string of numbers representing the firmware version currently installed.
8. Close the Send Serial Commands window to return to the main Vaddio Loader window.

**Put the EasyUSB Mixer/Amp in firmware update mode:**

1. Disconnect power from the EasyUSB Mixer/Amp and set DIP Switch 8 to the UP position (firmware update mode).
2. If two microphones are connected to the EasyUSB Mixer/Amp, disconnect one of them.
3. Reconnect power and wait for the unit to finish its power-up sequence. The EasyUSB Mixer/Amp is now ready to update the connected microphone.

**Install the update:**

1. From the product drop-down menu of Vaddio Loader, select the name of the microphone to be updated – CeilingMIC or TableMIC.
2. Choose 'Select Load File' and browse to the firmware you downloaded.
3. Select Start. The squares in the bottom right corner flash, the progress bar on the bottom starts to fill in, and the microphone's mute indicator blinks. The update takes a few minutes.

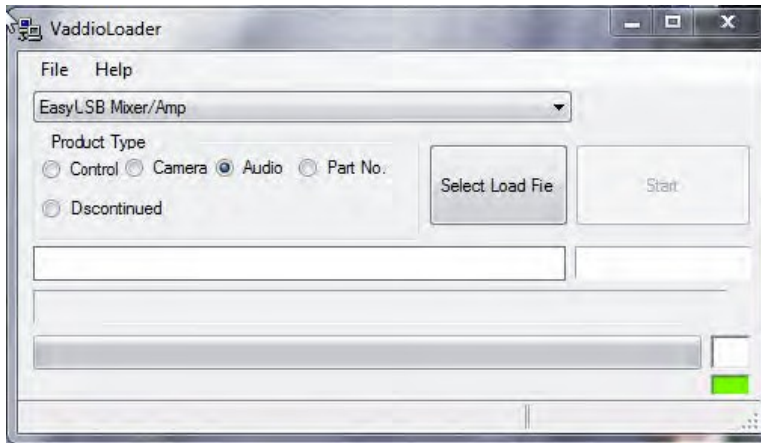

**Caution**

*Do not disconnect any cables until Vaddio Loader indicates a successful firmware load.*

4. When the Vaddio Loader displays the message "Firmware Load and Install Successful", the update is complete. Repeat the process if you need to update another microphone. Be sure to disconnect power from the EasyUSB Mixer/Amp before connecting or disconnecting microphones.

**Return the equipment to its normal operating state:**

1. When all updates are complete, disconnect power from the EasyUSB Mixer/Amp and set DIP Switch 8 to the DOWN position (normal operation).
2. Disconnect the EasyUSB Mixer/Amp from the computer, and reconnect all equipment in its usual configuration.

## Administration and Operation – EasyIP Microphones

This chapter is specific to the EasyIP CeilingMIC D with Dante networked audio. For information about the CeilingMIC, see [Working with EasyMic Microphones](#).

You will need the following applications to work with EasyIP microphones:

- **Dante Controller** – For routing microphones and speakers with Dante® connectivity to the A/V equipment. Download and install the free Dante Controller application from Audinate Pty. Ltd.: [www.audinate.com/products/software/dante-controller](http://www.audinate.com/products/software/dante-controller)
- **Vaddio Dante Interface Application** – For accessing EasyIP microphone settings and adjustments, and for updating EasyIP microphone firmware. Download the Vaddio Dante Interface Application from your microphone's page on [legrandav.com](http://legrandav.com).

### About Dante Technology and Devices

The Dante chip in each Dante device has its own IP address and device name. These do not correspond to devices' hostnames and IP addresses in their Vaddio web interfaces.

**Things to know about Dante technology and the Dante Controller application:**

- **Dante technology does not work over Wi-Fi.**
- **Dante Controller does not work across subnets.** Your computer must be on the same subnet as the Dante devices you need to work with.
- **Default device names and IP addresses shown in Dante Controller do not match the corresponding information shown in Vaddio devices' web interfaces.** The Dante chip in each Dante device has its own IP address and device name. The Dante Controller application uses this information.
- **Dante Controller allows you to rename devices**, so you can make their identifying labels match what's displayed in the Vaddio web interface. We recommend doing this.

Audinate provides the latest information, training, and documentation for Dante technology on their website. Information in this manual about Dante technology and Audinate products may be out of date.

## Locating and Pairing to Dante Devices

### DANTE CONTROLLER APPLICATION

#### Notes

The Dante chip in each EasyIP device has its own IP address and device name. The host device's name and IP address do not correspond to the hostname and IP address in its web interface.

#### To physically locate Dante devices using the Dante Controller application:

1. Open the Device Info tab to see the IP address and other information about each Dante device on the subnet that your computer is on.
2. From the main Network View, select Device : Device View. The Device View window opens.

Note that EasyIP devices will show the IP address of the Dante chip, not device's web server IP address.

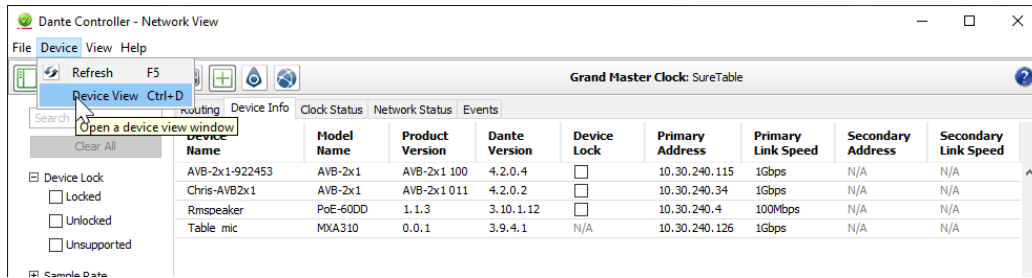

3. In the Device View window, select the device of interest. The window presents information about the device.

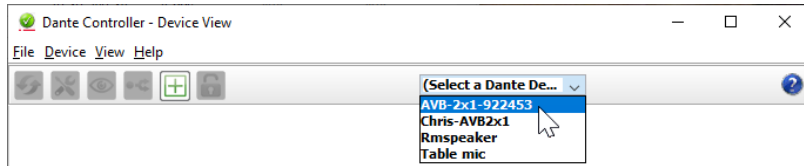

4. Select the Identify icon. The EasyIP microphone responds by blinking its mute light. To stop the identifying behavior, select the Identify icon again.

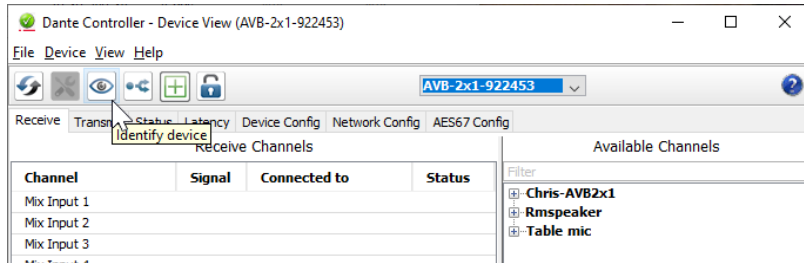

#### Other ways to access the Identify function:

The host device's Audio page provides an Identify button for EasyIP microphones.

The Vaddio Dante Interface Application includes an Identify button.

**To pair EasyIP microphones to the host device:**

1. From the main Network View, select Routing.
2. Use the matrix to pair Dante receivers (speakers) and transmitters (microphones) to the host device, which is both a receiver and a transmitter.

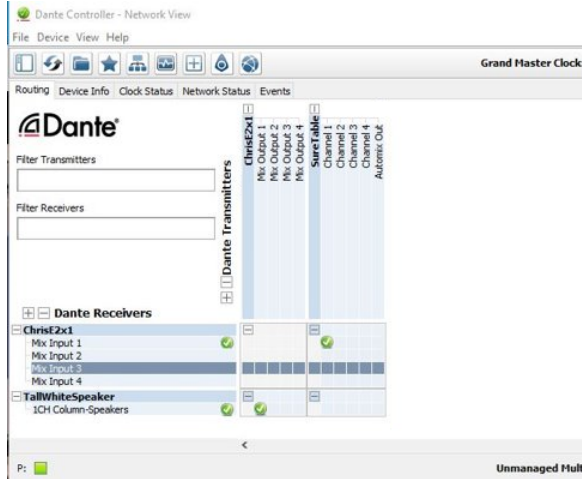

In this example, the receiver "Speaker" is routed to Dante output 1 of the device "ChrisE2x1". The transmitter "Table" (a tabletop microphone) is routed to the device's Dante input 1.

**To rename a device in the Dante Controller application:**

In the Device View window, select the device and go to its Device Config tab. The Rename Device option is near the top of the tab.

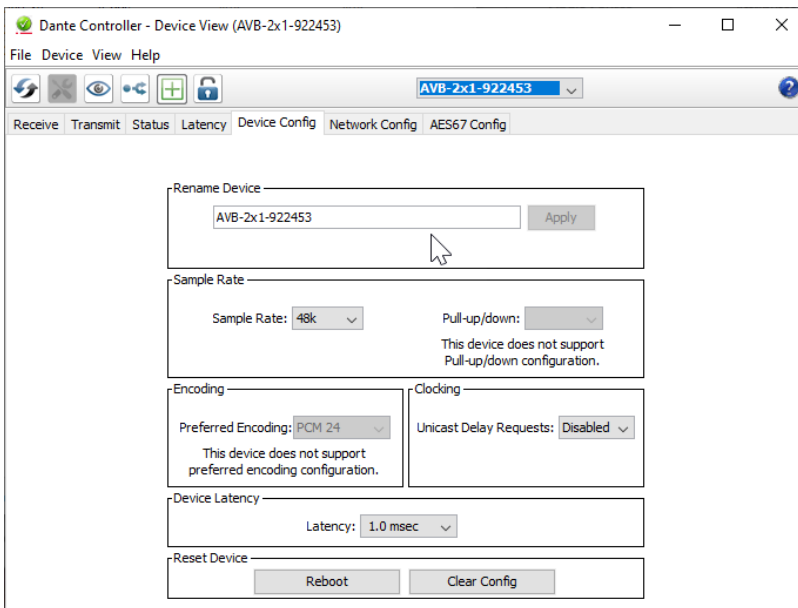

## Using More than Two EasyIP Microphones with a Vaddio Host Device

### DANTE CONTROLLER APPLICATION

In the examples that follow, we're working with a system that uses four Dante-connected microphones and a Dante-connected speaker. The system in the screen shots used an AV Bridge 2x1; the way it's configured in the Dante Controller application is exactly the same as it would be for other Dante-compatible Vaddio devices.

Your devices will be labeled differently from the devices in these screen shots.

For this configuration to work properly, we will need to do these things:

- *Route audio from the host device to the speaker, and route the same audio to the microphones as their AEC reference.* In the example set-up, this audio channel needs to be transmitted to five devices. To allow the signal to go to five places, we will need to **set up a multicast flow**.
- *Create two flows to route audio from the microphones back to the host device.* Although the AV Bridge 2x1 has four Dante input channels, it is limited to two transmit flows and two receive flows. This is also true of the EasyIP Mixer. We will need to **combine the four microphone channels into two flows**.

### About Channels and Flows

- A **channel** in a Dante environment is the same thing it would be in other environments: a signal from a single source.
- A **flow** in a Dante environment is one to four channels that can be routed from device to device. Channels remain separate within the flow. For example, left and right audio channels can be part of the same flow.
- By default, flows are **unicast** – they can only be routed to one receiving device.
- If one or more channels need to be routed to more than one device, the flow needs to be **multicast**. A multicast flow goes to all the receiving devices. Each device subscribes only to the channel it needs to receive.

This manual only covers the very most basic information about working with Dante products; Audinate Pty. Ltd. provides a great deal of useful information on their website. Please visit [www.audinate.com/learning](http://www.audinate.com/learning) for documentation, tutorials, whitepapers, and more.

## Creating a Multicast Flow

### DANTE CONTROLLER APPLICATION

To allow one audio channel from the host device to go to the speaker and also serve as the AEC reference signal that goes to the four microphones in our example set-up, define a multicast flow containing only that channel.

#### To define the multicast flow:

1. Select Device : Device View, and go to the Transmit tab.
2. Select the Multicast icon (labeled 1 in this screen shot).
3. Select the output from the host device. In this case we're using Dante Output 1, which is labeled Mix Output 1 in Dante Controller.
4. Select Create.

Now Dante Output 1 is available to every device that can receive it – the speaker and the four microphones. These devices will only use the channel in the multicast flow if it is routed to them.

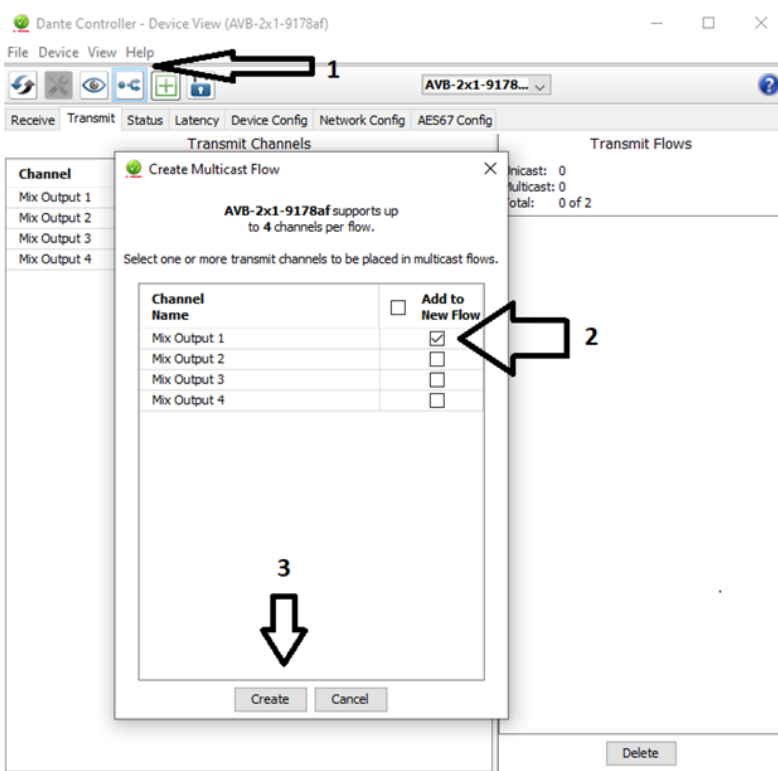



## Combining Microphone Channels into Flows

### DANTE CONTROLLER APPLICATION

The EasyIP Mixer or AV Bridge 2x1 can only receive two Dante audio flows. Each EasyIP microphone provides a pass-through channel as well as its own audio channel, so one microphone can be routed to another, which creates a flow with two microphone channels that can be routed to the host device. Think of it as daisy-chaining the microphones, but without the cable.

In the screen shot below, locate the microphones in the Dante Receivers column. Each receives its AEC reference from the Mix Output 1 channel that we set up as a multicast flow. Microphone EasyIP-1 also receives a pass-through channel from microphone EasyIP-3; microphone EasyIP-2 receives a pass-through channel from microphone EasyIP-4.

Each of the host device's four Mix Inputs receives the channel from the corresponding microphone, but the four channels are all coming from microphones EasyIP-1 and EasyIP-2.

The screenshot shows the Dante Controller Network View for device AVB-2x1-9178af. The interface includes a menu bar (File, Device, View, Help), a toolbar, and a routing matrix. The routing matrix is organized into two columns: Dante Transmitters and Dante Receivers. The Dante Receivers column lists the following channels:

- AVB-2x1-9178af (1..4)
  - Mix Input 1
  - Mix Input 2
  - Mix Input 3
  - Mix Input 4
- EasyIP-1 (1..2)
  - AEC Reference passthrough
- EasyIP-2 (1..2)
  - AEC Reference passthrough
- EasyIP-3 (1..2)
  - AEC Reference passthrough
- EasyIP-4 (1..2)
  - AEC Reference passthrough
- Speaker (1..4)
  - Output 1
  - NA
  - NA
  - NA

The Dante Transmitters column lists the following channels:

- AVB-2x1-9178af (1..4)
- EasyIP-1 (1..2)
  - EasyIP Microphone passthrough
- EasyIP-2 (1..2)
  - EasyIP Microphone passthrough
- EasyIP-3 (1..2)
  - EasyIP Microphone passthrough
- EasyIP-4 (1..2)
  - EasyIP Microphone passthrough
- Speaker (1..4)

The routing matrix shows connections (indicated by green checkmarks) as follows:

Receiver Channel	Transmitter: AVB-2x1-9178af (1..4)	Transmitter: EasyIP-1 (1..2) passthrough	Transmitter: EasyIP-2 (1..2) passthrough	Transmitter: EasyIP-3 (1..2) passthrough	Transmitter: EasyIP-4 (1..2) passthrough	Transmitter: Speaker (1..4)
AVB-2x1-9178af (1..4) - Mix Input 1		✓				
AVB-2x1-9178af (1..4) - Mix Input 2			✓			
AVB-2x1-9178af (1..4) - Mix Input 3		✓				
AVB-2x1-9178af (1..4) - Mix Input 4			✓			
EasyIP-1 (1..2) - AEC Reference passthrough	✓				✓	
EasyIP-2 (1..2) - AEC Reference passthrough	✓					✓
EasyIP-3 (1..2) - AEC Reference passthrough	✓	✓				
EasyIP-4 (1..2) - AEC Reference passthrough	✓	✓				
Speaker (1..4) - Output 1	✓					

**To route four microphones as two flows:**

1. Decide which two microphones will be routed to the host device. In our example, it's EasyIP-1 and EasyIP-2.
2. In the Network View, look under Dante Receivers to find the **passthrough** row for each of these two microphones. Read across the Dante Transmitters to find the EasyIP Microphone column for the microphone originating the signal that will pass through, and select the box where they intersect.

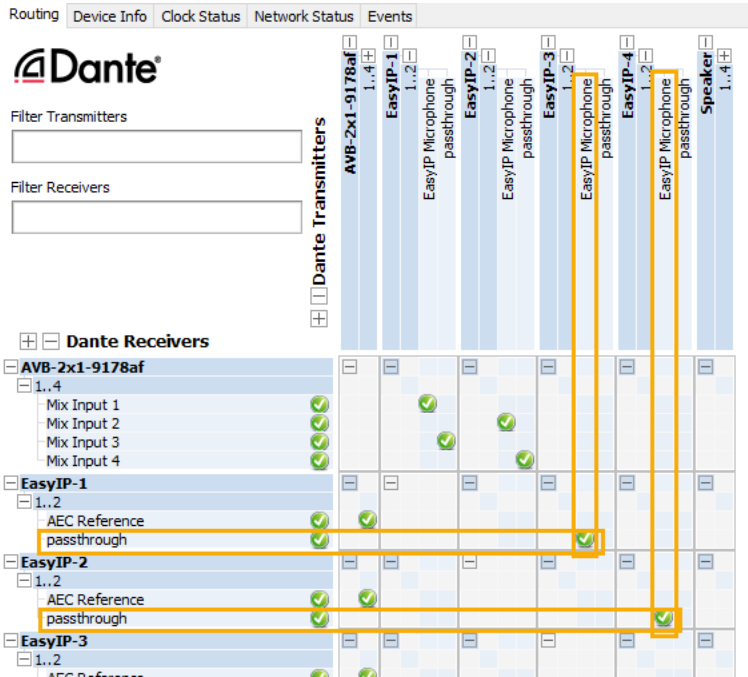

3. Find the rows for the host device's Dante inputs. In this example, it's Mix Input 1 through Mix Input 4 of AVB-2x1-9178af. Read across the Dante transmitters to find the two microphones receiving pass-through channels.
4. For each Mix Input, select the box where the Mix Input row intersects with either the EasyIP Microphone channel or the passthrough channel, to route each microphone to the desired input.

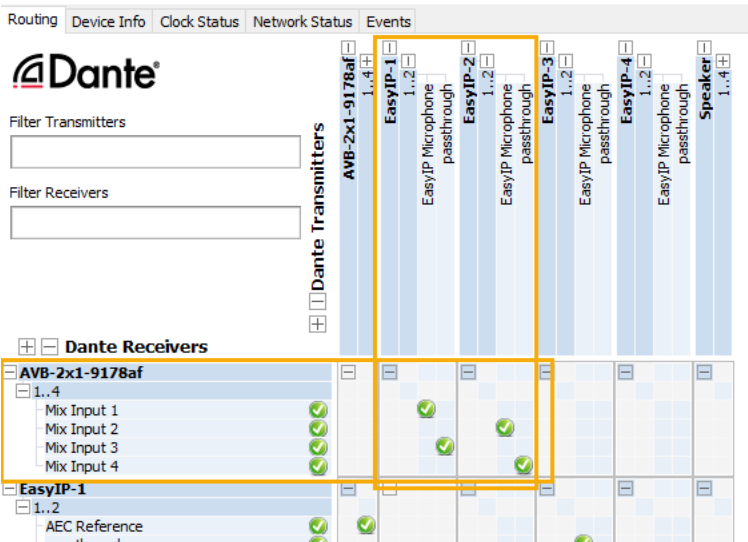

## Working with EasyIP Microphones

To work with EasyIP microphones, you will need to download the free Vaddio Dante Interface Application from the microphone's product page on [legrandav.com](http://legrandav.com). This application provides access to the microphone's adjustments.

### About the Vaddio Dante Interface Application

EasyIP and Dante technologies use differing communication protocols. Because of this, EasyIP microphone controls are not available from the web interface of the EasyIP host device, and the Vaddio Deployment Tool does not recognize them as Vaddio devices. To work with EasyIP microphones, you will need to download the free Vaddio Dante Interface Application from the microphone's product page on [legrandav.com](http://legrandav.com).

The Vaddio Dante Interface Application provides access to the microphone's adjustments. In the event that Vaddio releases an update to the microphone firmware, the Vaddio Dante Interface Application offers firmware update capability.

Things to know about the Vaddio Dante Interface Application:

- The application only detects EasyIP microphones.
- The application does not scan across subnets. Your computer must be on the same subnet as the microphones.

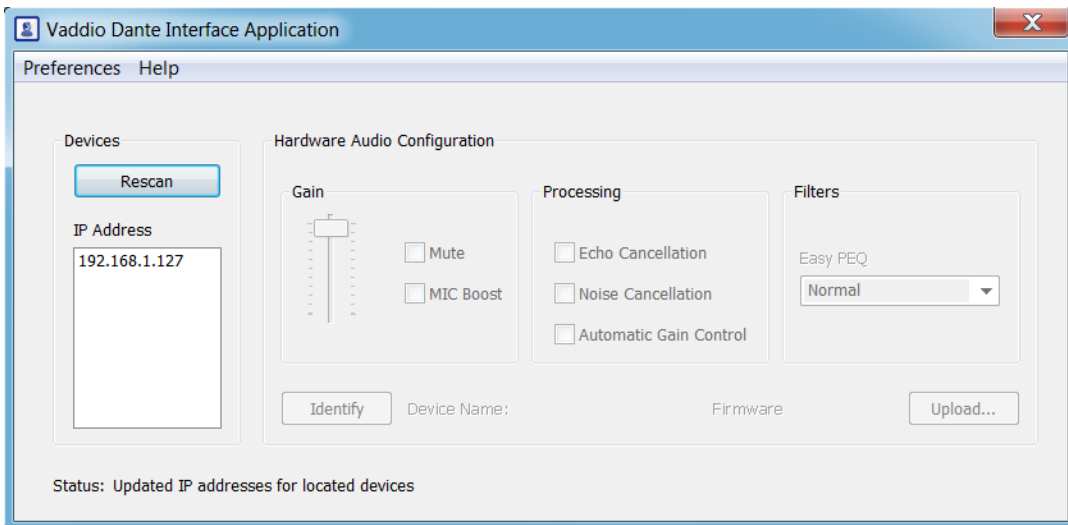

## Fine-Tuning EasyIP Microphone Performance

### VADDIO DANTE INTERFACE APPLICATION

The adjustments for EasyIP microphones are available via the free **Vaddio Dante Interface Application**. You'll find it on the Resources tab of your microphone's product page on [legrandav.com](http://legrandav.com).

When you open the Vaddio Dante Interface Application, it displays the IP addresses of the EasyIP microphones on the subnet. Select a microphone to enable its controls.

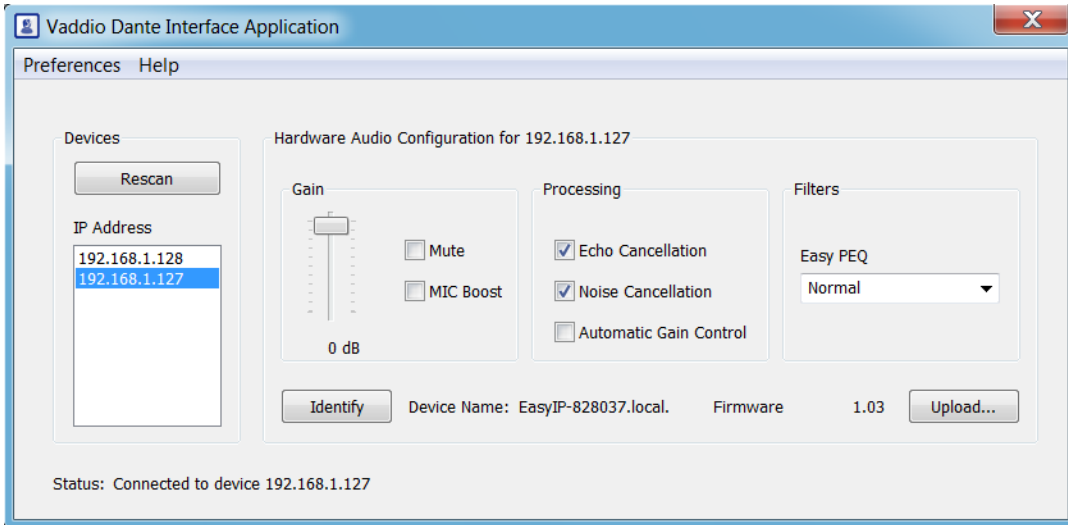

The adjustments and settings are the same as for the EasyMic family CeilingMIC and TableMIC microphones.

### Presentation Adjustments

You may need to adjust the microphones for the participants.

To accomplish this...	Do this
Help participants hear the person who is speaking.	Select the Mic Boost processing option to increase microphone gain overall. Use the slider to set the gain. From the Easy PEQ menu, select Speech Enhancement to increase gain in the frequency range for speech.
Automatically adjust for differences in volume as different people speak	Enable Automatic Gain Control for the appropriate microphone.

## Performance Adjustments

You may need to adjust the microphones to suit the room. Echo cancellation and noise cancellation are on by default; we recommend leaving them on.

To correct this...	Do this
Reverberant room	From the Easy PEQ menu, select Reverberant Room.
Noisy environment	From the Easy PEQ menu, select Ambient Noise to reduce gain in the frequencies above and below the normal speech range.
Participants may be seated beyond the microphones' optimum pick-up range	From the Easy PEQ menu, select Speech Enhancement to increase gain in the frequency range for speech. Select the Mic Boost processing option to increase microphone gain overall.

Devices

Rescan

IP Address

192.168.1.127

Hardware Audio Configuration for 192.168.1.127

Gain

0 dB

Mute

MIC Boost

Processing

Echo Cancellation

Noise Cancellation

Automatic Gain Control

Filters

Easy PEQ

Normal

Normal

Reverberant Room

Ambient Noise

Speech Enhancement

Identify Device Name: EasyIP-828037.local Firmware Version: 1.03 Upload...

Status: Connected to device 192.168.1.127

## Installing a Firmware Update for an EasyIP Microphone

### VADDIO DANTE INTERFACE APPLICATION

You will need the **Vaddio Dante Interface Application** to update EasyIP microphone firmware. This free application is available from [legrandav.com](http://legrandav.com) on the Resources tab of your microphone's product page.

When you open the Vaddio Dante Interface Application, it displays the IP addresses of the EasyIP microphones on the subnet.

#### To update EasyIP microphone firmware:

1. Download the firmware and release notes. Microphone firmware is available on the microphone product page.
2. Open the Vaddio Dante Interface Application if you have not done so already.
3. Select the microphone to update.

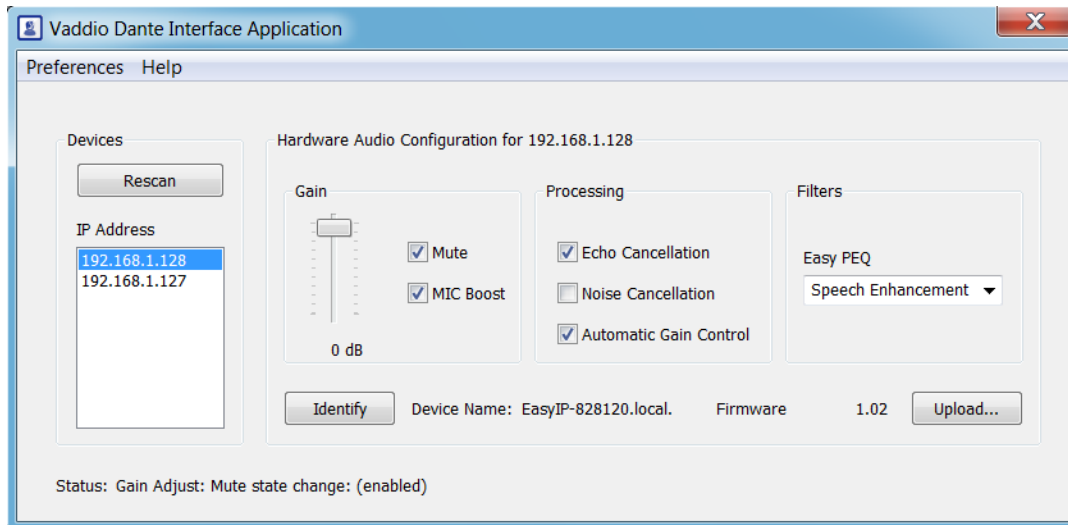

4. Select Upload and navigate to the firmware file.

Do not disconnect the microphone while the progress bar is displayed.

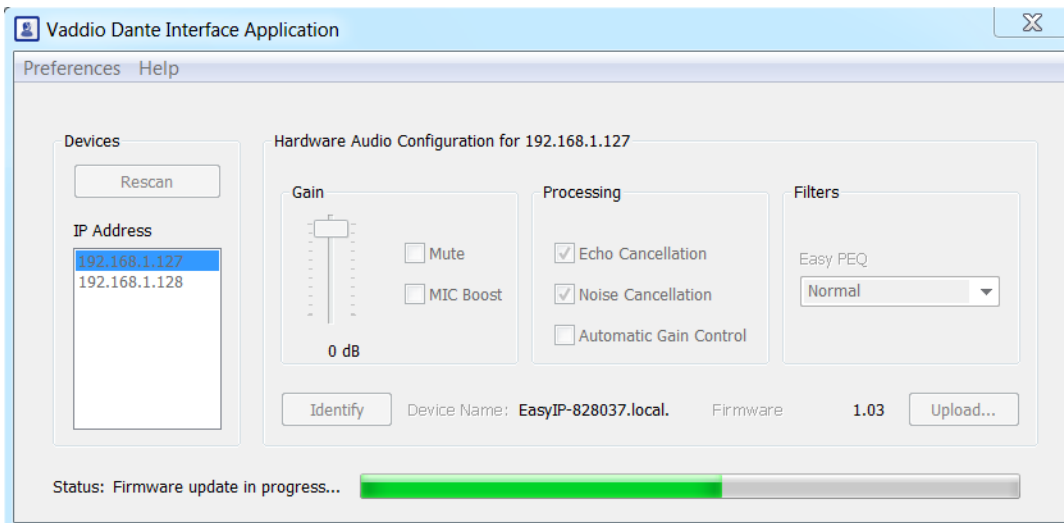

## Specifications

Performance, environmental, and physical specifications are the same for EasyMic and EasyIP microphones.

### Performance

Frequency Response	100 Hz to 16 KHz
THD + Noise	< 0.02%
Dynamic Range	> 90 dB

### Environmental and Physical

Operating/Storage Temperature	32°F to 104°F (0°C to 40°C)
Operating/Storage Humidity	10% to 80% (non-condensing)
Maximum Cabling Distance	Drop cable: 15 ft (4.6 m) Interface box to host device: 100 ft (30 m)
Interface Box Dimensions	Length including flange: 10.25 in (26 cm) Width: 4.6 in (11.7 cm) Height: 2 in. (5.1 cm)
Microphone body dimensions	2.5 in. (6.3 cm) diameter
Installed Weight	2 lbs (0.9 kg, or 422 2x4 LEGO blocks)

## Troubleshooting

What is it doing?	Possible causes	Check and correct
CeilingMIC: Nothing. Connected devices do not recognize the microphone.	The cable from the ceiling box to the AV or conferencing device is not connected, or is bad.	Verify that the cable is connected to the device.
	The drop cable is not fully seated at one end, or is bad.	Check the cable for correct pin-out and continuity.
EasyIP CeilingMIC D: Dante Controller cannot locate the device.	The cable from the ceiling box to the PoE+ switch is not connected, or is bad.	Verify that the cable is connected to the switch.
	The drop cable is not fully seated at one end, or is bad.	Check the cable for correct pin-out and continuity.
Participants at the far end report no audio.	The microphone is muted.	If the indicator light on the microphone is on, it is muted. Unmute it from the device that controls it.
	EasyIP CeilingMIC D: The microphone is not paired to the conferencing device.	Use the Dante Controller application to pair the microphone with the conferencing device.
The connected device does not recognize the microphone.	The device may have outdated firmware.	Download the latest firmware from the device's product page, and update the device.
Participants at the far end report that the audio does not sound natural.	The audio has not been adjusted properly for the room.	Adjust the microphone from the device that controls it.

## Use, Storage, and Care

Keep this device away from food and liquids. Do not attempt to take this product apart. There are no user-serviceable components inside. Do not operate or store the device under any of the following conditions:

- Temperatures above 104° F (40° C) or below 32° F (0° C)
- High humidity, condensing or wet environments
- Inclement weather
- Severe vibration
- Dry environments with an excess of static discharge

Do not let cats play with overhead microphones, as their claws could snag the fabric.



## Compliance and Conformity Statements

Compliance testing was performed to the following regulations:

FCC Part 15 (15.107, 15.109), Subpart B	Class A
ICES-003, Issue 54: 2012	Class A
EMC Directive 2014/30/EU	Class A
EN 55032: 2015	Class A
EN 55024: November 2010	Class A
IEC 60950-1:2005 (2nd Edition); Am 1: 2009 + Am 2: 2013	Safety
EN 60950-1: 2006 + A11: 2009 + A1: 2010 + A12: 2011 + A2: 2013	Safety

### FCC Part 15 Compliance

This equipment has been tested and found to comply with the limits for a Class A digital device, pursuant to Part 15, Subpart B, of the FCC Rules. These limits are designed to provide reasonable protection against harmful interference when the equipment is operated in a commercial environment. This equipment generates, uses, and can radiate radio frequency energy and, if not installed and used in accordance with the instruction manual, may cause harmful interference to radio communications. Operation of this equipment in a residential area is likely to cause harmful interference in which case the user will be required to correct the interference at his/her own expense.

Operation is subject to the following two conditions: (1) This device may not cause interference, and (2) This device must accept any interference including interference that may cause undesired operation of the device.

Changes or modifications not expressly approved by Vaddio can affect emission compliance and could void the user's authority to operate this equipment.



### ICES-003 Compliance

This digital apparatus does not exceed the Class A limits for radio noise emissions from digital apparatus set out in the Radio Interference Regulations of the Canadian Department of Communications.

Le présent appareil numérique n'émet pas de bruits radioélectriques dépassant les limites applicables aux appareils numériques de la classe A prescrites dans le Règlement sur le brouillage radioélectrique édicté par le ministère des Communications du Canada.



## European Compliance

This product has been evaluated for Electromagnetic Compatibility under the EMC Directive for Emissions and Immunity and meets the requirements for a Class A digital device. In a domestic environment this product may cause radio interference in which case the user may be required to take adequate measures.

**Standard(s) To Which Conformity Is Declared:**



EMC Directive 2014/30/EU

EN 55032: 2015 – Conducted and Radiated Emissions

EN 55024: November 2010 – Immunity

IEC 60950-1: 2005 (2nd Edition); Am 1: 2009 + Am 2: 2013 – Safety

EN 60950-1: 2006 + A11: 2009 + A1: 2010 + A12: 2011 + A2: 2013 – Safety

IEC 62368-1: 2014 (2nd Edition) – Safety

## Photo Credits

This guide may include some or all of these photos.

European Space Agency (ESA) astronaut Samantha Cristoforetti, a Flight Engineer with Expedition 42, photographs the Earth through a window in the Cupola on the International Space Station

By NASA - [https://blogs.nasa.gov/ISS\\_Science\\_Blog/2015/03/06/women-in-space-part-two-whats-gender-got-to-do-with-it/](https://blogs.nasa.gov/ISS_Science_Blog/2015/03/06/women-in-space-part-two-whats-gender-got-to-do-with-it/), Public Domain, <https://commons.wikimedia.org/w/index.php?curid=38834990>

Carl Sagan, Bruce Murray, Louis Friedman (founders) and Harry Ashmore (advisor), on the occasion of signing the papers formally incorporating The Planetary Society

By credit NASA JPL - JPL, Public Domain, <https://commons.wikimedia.org/w/index.php?curid=1180927>

Main Control Room / Mission Control Room of ESA at the European Space Operations Centre (ESOC) in Darmstadt, Germany

By European Space Agency - ESOC flickr, Credit: ESA - Jürgen Mai, CC BY-SA 3.0-igo,

<https://commons.wikimedia.org/w/index.php?curid=36743173>

Expedition 42 on orbit crew portrait, International Space Station, Mar. 7, 2015 – Barry Wilmore (Commander) Top, Upside down, to the right cosmonaut Elena Serova, & ESA European Space Agency Samantha Cristoforetti. Bottom center US astronaut Terry Virts, top left cosmonauts Alexander Samokutyaev and Anton Shkaplerov.

By NASA - <https://www.flickr.com/photos/nasa2explore/16166230844/>, Public Domain,

<https://commons.wikimedia.org/w/index.php?curid=38931301>

European Space Agency astronaut Luca Parmitano, Expedition 36 flight engineer, outside the International Space Station

By NASA - <http://spaceflight.nasa.gov/gallery/images/station/crew-36/html/iss036e016704.html>, Public Domain, <https://commons.wikimedia.org/w/index.php?curid=27263573>

Chris Cassidy, Luca Parmitano, and Karen Nyberg, ISS, 2013. Photo Credit: NASA

Nicolas Altobelli, Rosetta Scientist at ESA's European Space Astronomy Centre, Villanueva de la Cañada, Madrid, Spain

By European Space Agency - Nicolas Altobelli talks to the media, CC BY-SA 3.0-igo,

<https://commons.wikimedia.org/w/index.php?curid=36743144>

Andrea Accomazzo, ESA Rosetta Spacecraft Operations Manager, providing a live update from the Main Control Room at ESA's European Space Operations Centre, Darmstadt, Germany during the Rosetta wake-up day.

By European Space Agency - Live update from the Main Control Room, CC BY-SA 3.0-igo,

<https://commons.wikimedia.org/w/index.php?curid=36743150>

Sleeping goose

By ladypine - Own work, CC BY-SA 3.0, <https://commons.wikimedia.org/w/index.php?curid=1695227>

By Rick Dikeman - Image:Wayne Gretzky 1997.jpg, CC BY-SA 3.0,

<https://commons.wikimedia.org/w/index.php?curid=945698>

Photo AS11-40-5948, Aldrin assembles seismic experiment, by National Aeronautics and Space Administration, courtesy of the NASA History Office and the NASA JSC Media Services Center

# Index

## A

- AEC 21-22
- AGC (automatic gain control) 25
- anatomy of the microphone 3
- audio 25-26
  - adjustments 25-26
  - controls 25-26

## C

- cable connectors 5
- cleaning 29
- compatibility, hardware 1
- connection diagram 8, 10
- controls 11

## D

- daisy-chaining Dante microphones 22-23
- damage, preventing 5
- Dante Controller (application) 10-11, 18-23
- Dante devices 10, 18-23
  - "identify" function 18
  - discovering IP address 18
  - renaming 19
  - routing audio 19
- diagnosing issues 29
- diagram, connection 8, 10
- dynamic range 25-26

## E

- Easy PEQ settings 25-26
- echo cancellation 26

## F

- fault isolation 29
- firmware update 12-16, 27
- flow (Dante) 20-23
  - multi-channel 22-23
  - multicast 20-21
  - unicast 20

## I

- Identify (device function) 18
- installation 4, 6-8, 10
  - boot and trim ring 8
  - cabling 7
  - microphone height 6

- placement 7
- tips for success 4
- tools 4
- typical connections 8, 10
- IP address 18
  - Dante device, discovering 18

## M

- Mic Boost (audio setting) 25-26
- microphone pass-through (Dante) 22-23
- microphones 21-23, 27
  - firmware update 27
- multicast flow (Dante) 20-21
- muting 11

## N

- noise cancellation 26

## O

- operating environment 5, 29

## P

- packing list 2
- pairing 19-20, 22
  - to Dante devices 19-20, 22
- part numbers 1-2
- performance specifications 28
- precautions 5
  - for operating the system 5

## R

- RJ-45 connectors 5
- routing (pairing) Dante microphones 11
- routing audio 20, 22-23
  - using Dante Controller 20, 22-23

## S

- software update 12-16, 27
- solving problems 29
- storage environment 29

## T

- technical specifications 28
- temperature, operating and storage 29

## U

- unicast flow (Dante) 20
- update 12-16, 27

**V**

Vaddio Dante Interface Application 11, 24-25,  
27

visual packing list 2

visual parts identification 3

**W**

warranty 5

Vaddio is a brand of Legrand AV Inc. · [www.legrandav.com](http://www.legrandav.com) · Phone 800.572.2011 / +1.763.971.4400 · Fax +1.763.971.4464 · Email [av.vaddio.support@legrand.com](mailto:av.vaddio.support@legrand.com)

Visit us at [www.legrandav.com](http://www.legrandav.com) for firmware updates, specifications, drawings, manuals, technical support information, and more.

©2020 Legrand AV Inc.

Vaddio is a registered trademark of Legrand AV Inc. Audinate®, the Audinate logo and Dante® are registered trademarks of Audinate Pty Ltd. All other brand names or marks are used for identification purposes and are trademarks of their respective owners. All patents are protected under existing designations. Other patents pending.

**A brand of  legrand®**

**Commercial AV Brands** Chief | Da-Lite | Middle Atlantic | Projecta | Vaddio

**vaddio®**