

KRAMER



USER MANUAL

MODEL:

DIP-31

Automatic Video Switcher



DIP-31 Quick Start Guide

This guide helps you install and use your **DIP-31** for the first time. Go to <http://www.kramerav.com/manual/DIP-31> to download the latest user manual (or scan the QR code) and check if firmware upgrades are available.

Step 1: Check what's in the box

- ✓ **DIP-31** Automatic Video Switcher
- ✓ 4 Rubber feet
- ✓ ADC-DPM/HF DisplayPort (M) to HDMI (F) adapter cable
- ✓ 1 Power supply (12V DC)
- ✓ 1 Quick start guide

Step 2: Install the DIP-31

To mount the **DIP-31** in a rack, use an **RK-T2B** rack adapter. Alternatively, attach the rubber feet to the underside of the machine and place it on a table. You can use the **TOOL** bracket Installation kit (supplied) to mount the **DIP-31** on a desktop, wall or similar area. Fasten a bracket on each side of the **TOOL** using the two M3x8 screws (supplied). Use the flat-head screws (supplied) to fix the **TOOL** to the mounting surface or enable it to slide in place.

Step 3: Connect inputs and outputs

Always switch OFF the power on each device before connecting it to your **DIP-31**. For best results, we recommend that you always use Kramer high-performance cables to connect AV equipment to the **DIP-31**.

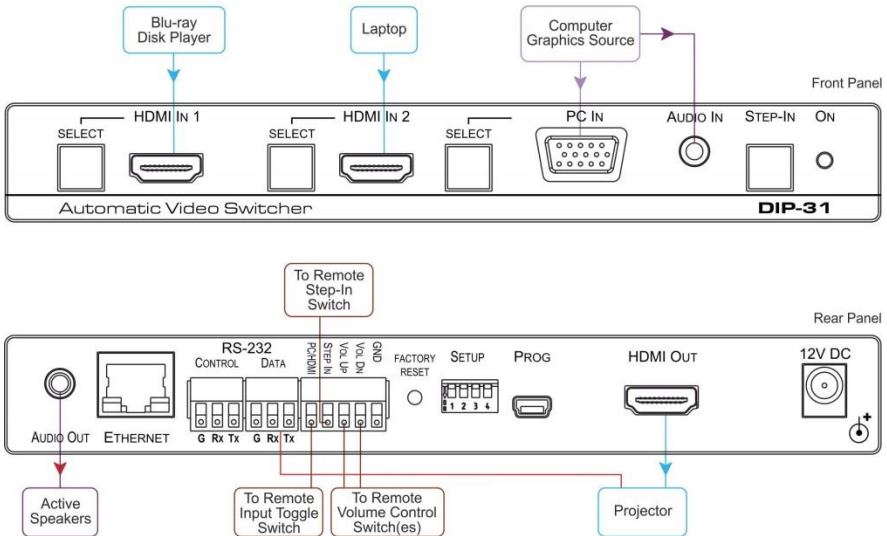

Step 4: Set the DIP-switches

Video Switching Selection

DIP-switch 1	DIP-switch 2	Video Input Selection
Off (up)	Off (up)	Automatic—Last connected. Where more than one source is connected the last one connected has priority
Off (up)	On (down)	Automatic—Priority selection. HDMI 1 → HDMI 2 → PC IN (default, high to low priority)
On (down)	Off (up)	Manual
On (down)	On (down)	Manual

Audio Switching Selection

DIP-switch 3	DIP-switch 4	Audio Input Selection
Off (up)	Off (up)	Automatic—Priority selection. Embedded HDMI → analog Audio In (high to low priority)
Off (up)	On (down)	Automatic—Priority selection. Analog Audio In → embedded HDMI (high to low priority)
On (down)	Off (up)	Embedded HDMI
On (down)	On (down)	Analog Audio In

Step 5: Connect the power

Connect the power adapter to the **DIP-31**, and plug the adapter into the mains power. Power on all attached devices.



Step 6: Operate the DIP-31

Default IP Parameters

Parameter	Values	Default
Device Name	Any alphanumeric string up to 14 chars (can include hyphen, but not at the beginning or end)	KRAMER_
DHCP	ON/OFF	OFF
IP Address	Any valid IP address	192.168.1.39
Mask	Any valid network mask	255.255.0.0
Gateway	Any valid gateway address	192.168.0.1
TCP Port	0 to 65535	5000
UDP Port	0 to 65535	50000

Default Web Pages Logon Authentication

Parameter	Values
Name	Admin
Password	Admin

You can operate the **DIP-31** via the front panel buttons, remote P3000 commands, or by using a Web browser to access the built in Web pages.

Contents

1	Introduction	1
2	Getting Started	2
2.1	Achieving the Best Performance	2
2.2	Safety Instructions	2
2.3	Recycling Kramer Products	3
3	Overview	4
4	Defining the Automatic Video Switcher	5
5	Connecting the DIP-31 Automatic Video Switcher	7
5.1	Connecting the Remote Control Switches	9
5.2	Wiring the RJ-45 Connectors	10
6	Principles of Operation	11
6.1	Input Selection	11
6.2	Signal Loss and Unplugged Cable Timeouts	12
6.3	Audio Signal Control	12
6.4	VGA Phase Shift	13
7	Operating the DIP-31	14
7.1	Locking the EDID	14
7.2	Resetting the DIP-31	14
7.3	Analog Audio Output Volume Control	15
8	Configuring the DIP-31	16
8.1	Setting the Configuration DIP-switch	16
8.2	Switching Timeouts	17
8.3	Using the Step-in Feature	17
9	Operating the DIP-31 Remotely Using the Web Pages	18
9.1	Browsing the DIP-31 Web Pages	18
9.2	Switching Page	23
9.3	Device Settings Page	24
9.4	Remote Device Control Page	26
9.5	Video and Audio Settings Page	27
9.6	Authentication Page	28
9.7	EDID Page	30
9.8	About Us Page	32
10	Technical Specifications	33
10.1	Default IP Parameters	34
10.2	Default Logon Credentials	34
10.3	Supported HDMI Resolutions	34
10.4	Supported VGA Resolutions	35
11	Default EDID	36
11.1	HDMI	36
11.2	PC-UXGA	38
12	Protocol 3000	40
12.1	Understanding Protocol 3000	41
12.2	Kramer Protocol 3000 Syntax	43
12.3	Protocol 3000 Commands	44

Figures

Figure 1: DIP-31 Front Panel	5
Figure 2: DIP-31 Rear Panel	6
Figure 3: Connecting the DIP-31	7
Figure 4: Remote Switches Terminal Block	9
Figure 5: TP PINOUT	10
Figure 6: Configuration DIP-switch	16
Figure 7: Entering Logon Credentials	19
Figure 8: Default Page	20
Figure 9: Main Switching Page	21
Figure 10: Switching Page	23
Figure 11: Device Settings Page	24
Figure 12: Video and Audio Settings Page	27
Figure 13: Authentication Page	28
Figure 14: EDID Page	30
Figure 15: About Us Page	32

1 Introduction

Welcome to Kramer Electronics! Since 1981, Kramer Electronics has been providing a world of unique, creative, and affordable solutions to the vast range of problems that confront video, audio, presentation, and broadcasting professionals on a daily basis. In recent years, we have redesigned and upgraded most of our line, making the best even better!

Our 1,000-plus different models now appear in 14 groups that are clearly defined by function: GROUP 1: Distribution Amplifiers; GROUP 2: Switchers and Routers; GROUP 3: Control Systems; GROUP 4: Format/Standards Converters; GROUP 5: Range Extenders and Repeaters; GROUP 6: Specialty AV Products; GROUP 7: Scan Converters and Scalers; GROUP 8: Cables and Connectors; GROUP 9: Room Connectivity; GROUP 10: Accessories and Rack Adapters; GROUP 11: Sierra Video Products; GROUP 12: Digital Signage; GROUP 13: Audio; and GROUP 14: Collaboration.

Congratulations on purchasing your Kramer **DIP-31** *Automatic Video Switcher* which are part of the Kramer Audio Distribution System and are ideal for:

- Display systems requiring simple, automatic input selection.
- Multimedia and presentation source selection.
- Video distribution in hotel rooms and schools.

2 Getting Started

We recommend that you:

- Unpack the equipment carefully and save the original box and packaging materials for possible future shipment.
- Review the contents of this user manual.



Go to <http://www.kramerav.com/downloads/DIP-31> to check for up-to-date user manuals, application programs, and to check if firmware upgrades are available (where appropriate).

2.1 Achieving the Best Performance

To achieve the best performance:

- Use only good quality connection cables (we recommend Kramer high-performance, high-resolution cables) to avoid interference, deterioration in signal quality due to poor matching, and elevated noise levels (often associated with low quality cables).
- Do not secure the cables in tight bundles or roll the slack into tight coils.
- Avoid interference from neighboring electrical appliances that may adversely influence signal quality.
- Position your **DIP-31 Automatic Video Switcher** away from moisture, excessive sunlight and dust.



This equipment is to be used only inside a building. It may only be connected to other equipment that is installed inside a building.

2.2 Safety Instructions



Caution: There are no operator serviceable parts inside the unit

Warning: Use only the power cord that is supplied with the unit

Warning: Do not open the unit. High voltages can cause electrical shock! Servicing by qualified personnel only

Warning: Disconnect the power and unplug the unit from the wall before installing

2.3 Recycling Kramer Products

The Waste Electrical and Electronic Equipment (WEEE) Directive 2002/96/EC aims to reduce the amount of WEEE sent for disposal to landfill or incineration by requiring it to be collected and recycled. To comply with the WEEE Directive, Kramer Electronics has made arrangements with the European Advanced Recycling Network (EARN) and will cover any costs of treatment, recycling and recovery of waste Kramer Electronics branded equipment on arrival at the EARN facility. For details of Kramer's recycling arrangements in your particular country go to our recycling pages at <http://www.kramerav.com/support/recycling/>.

3 Overview

DIP-31 is a 4K UHD automatic switcher for HDMI, VGA, Ethernet, data and unbalanced audio signals. The unit supports resolutions up to 4K@60Hz (4:2:0) UHD and various modes of input selection and transmits the signal via HDMI cable to a compatible receiver (for example the **VS-62H** or when connecting directly to a display/projector). **DIP-31** is a Step-in commander when connected to a matrix switcher that supports Step-in over HDMI such as the **VS-62H**.

The **DIP-31 Automatic Video Switcher** features:

- Max. Resolution – 4K@60Hz (4:2:0) UHD and WUXGA.
- Max. Data Rate – 10.2Gbps (3.4Gbps per graphic channel).
- HDTV support
- HDCP compliancy – works with sources that support HDCP repeater mode
- HDMI with Deep Color, x.v.Color™ and 3D
- I-EDIDPro™ Kramer Intelligent EDID Processing™ – Intelligent EDID handling & processing algorithm ensures Plug and Play operation for HDMI systems
- Automatic live input detection based on video clock presence
- Automatic input selection based on priority selection or last connected input
- Manual input selection
- Step-in control when connected to a device that provides step-in support
- Automatic analog audio detection and embedding
- Control via Kramer Protocol 3000 and embedded Web pages over a LAN
- A lockable EDID
- Remote control via contact-closure switches
- Equalization and re-clocking of the data
- Support for digital audio formats
- An RS-232 data port for controlling external devices

4 Defining the Automatic Video Switcher

Figure 1 defines the front panel of the **DIP-31**.

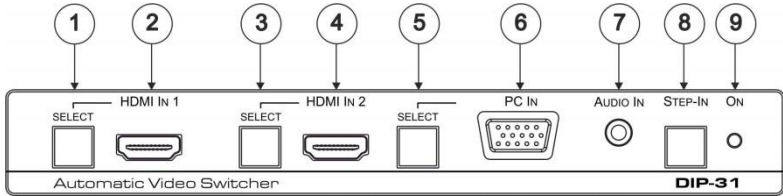

Figure 1: DIP-31 Front Panel

#	Feature	Function
1	HDMI IN 1	SELECT Button Press to select the HDMI In 1 input. When HDMI In 1 is selected, the button: <ul style="list-style-type: none"> • Lights red when external audio is selected • Lights green when HDMI In 1 is selected
2		HDMI 1 Connector Connect to the first HDMI source
3	HDMI IN 2	SELECT Button Press to select the HDMI In 2 input. When HDMI In 2 is selected, the button: <ul style="list-style-type: none"> • Lights red when external audio is selected • Lights green when HDMI In 2 is selected
4		HDMI 2 Connector Connect to the second HDMI source
5	PC IN	SELECT Button Press to select the PC graphics input. When PC graphics is selected, the button: <ul style="list-style-type: none"> • Lights red when external audio is selected • Lights green when the PC input selected
6		PC Graphics 15-pin HD Connector Connect to the PC graphics source, (for example, a laptop)
7	AUDIO IN 3.5mm Mini Jack Connect to the unbalanced, stereo audio source, (for example, the audio output of the laptop)	
8	Step-In Button Press to take control of the input that this device is connected to on a compatible switcher	
9	ON LED Lights green when the device is powered on	

Figure 2 defines the rear panel of the DIP-31.

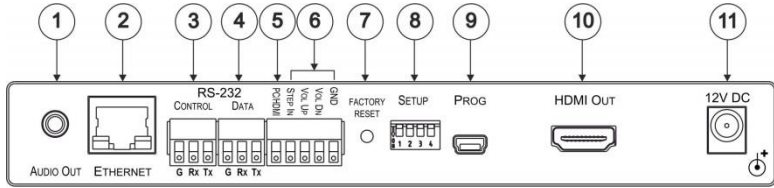

Figure 2: DIP-31 Rear Panel

#	Feature	Function	
1	AUDIO OUT 3.5mm Mini Jack	Connect to the unbalanced, stereo audio acceptor, (for example, active speakers)	
2	ETHERNET RJ-45 Connector	Connect to the LAN, (Ethernet traffic or PC controller)	
3	RS-232	CONTROL 3-pin Terminal Block	Connect to a serial controller or PC
4		DATA 3-pin Terminal Block	Connect to a serial data source or acceptor
5	PC/HDMI Remote Toggle Switch Terminal Block	Connect to a remote momentary switch to toggle between the PC graphics and HDMI inputs	
6	Remote Contact-closure 4-pin Terminal Block	Connect to remote momentary switches to control step-in and audio volume	
7	FACTORY RESET Button	Short press to reboot, long press to reset the device to factory default parameters	
8	SETUP 4-way DIP-switch	Switches for setting the device behavior, (see Section 8.1)	
9	PROG Mini USB Connector	Connect to a PC to perform a firmware upgrade	
10	HDMI OUT Connector	Connect to a compatible HDMI display	
11	12V DC Connector	Connect to the supplied power adapter	

5 Connecting the DIP-31 Automatic Video Switcher



Always switch off the power to each device before connecting it to your **DIP-31**. After connecting your **DIP-31**, connect the power to each of them and then switch on the power to each device.

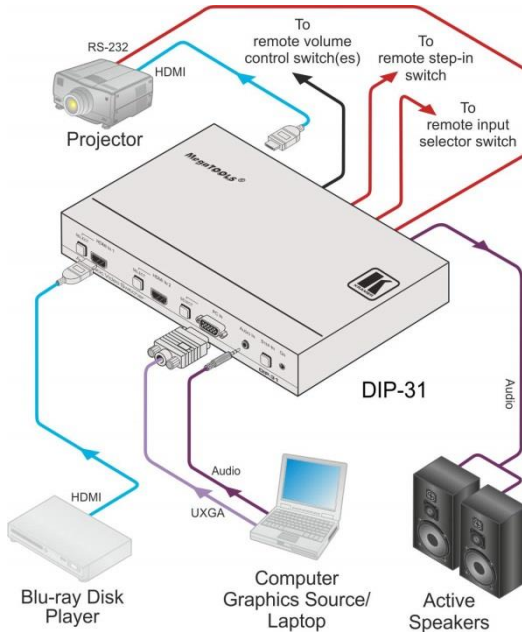

Figure 3: Connecting the DIP-31

To connect the DIP-31 as illustrated in [Figure 3](#):

1. Connect an HDMI source, (for example, a Blu-ray disk player) to the HDMI IN 1 input.
2. Connect a PC graphics source, (for example, a laptop) to the PC In input.
3. Connect an unbalanced stereo audio source, (for example, the audio output from the laptop) to the AUDIO IN 3.5mm mini jack.

4. Connect the HDMI OUT connector on the rear panel of the **DIP-31** to an HDMI compatible switcher, display or projector.
5. Connect the DATA RS-232 3-pin terminal block on the rear panel of the **DIP-31** to an RS-232 controlled device (for example, a projector) or an RS-232 controller.
6. Connect the AUDIO OUT 3-pin terminal block on the rear panel of the **DIP-31** to the unbalanced, stereo audio acceptor, (for example, active speakers).
7. Connect the STEP IN 2-way terminal block to a momentary, contact-closure switch, (see [Section 5.1](#)).
8. Connect the PC/HDMI 2-way terminal block to a momentary, contact-closure switch for input selection, (see [Section 5.1](#)).
9. Connect the Vol Up/Vol Down 3-pin terminal block to remote, contact-closure, volume control switches.
10. Connect the power adapter to the **DIP-31** and to the mains power, (not shown in [Figure 3](#)).

5.1 Connecting the Remote Control Switches

You can connect remote, momentary-contact contact-closure switches to the terminal block on the rear panel of the **DIP-31** to control the device.

[Figure 4](#) illustrates the connections from the terminal block to the contact-closure switches.

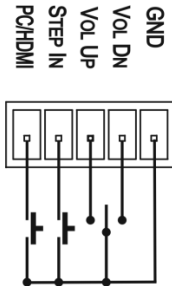

Figure 4: Remote Switches Terminal Block

#	Feature	Function
1	PC/HDMI—input selection/VGA phase shift adjustment	Short press—Input toggle Long press—Adjusts the VGA phase shift, (see Section 6.4)
2	STEP IN	Activates the step-in function if relevant
3	VOL UP—analog audio output volume increase control, (see Section 7.3)	Short press—Increases the volume one step Long press—Increases the volume from 0% to 100% in 10 seconds
4	VOL DN—analog audio output volume decrease control, (see Section 7.3)	Short press—Decreases the volume one step Long press—Decreases the volume from 100% to 0% in 10 seconds
G	GND	Connect to the common side of the switches

5.2 Wiring the RJ-45 Connectors

This section defines the TP pinout, using a straight pin-to-pin cable with RJ-45 connectors.

EIA /TIA 568B	
PIN	Wire Color
1	Orange / White
2	Orange
3	Green / White
4	Blue
5	Blue / White
6	Green
7	Brown / White
8	Brown

Figure 5: TP PINOUT

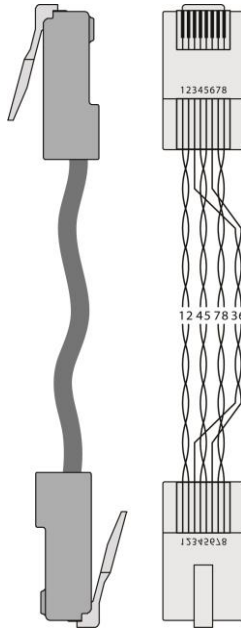

6 Principles of Operation

The **DIP-31** selects video and audio inputs based on the rules described below.

6.1 Input Selection

The video mode selection is set by the DIP-switches (see [Section 8.1](#)) to either of the following modes:

- Manual
- Auto—Last connected or priority mode

In manual mode switching occurs whether or not there is a live signal present on the input. You select manually select an input using any of the following methods:

- Front panel buttons
- Remote input selection switches
- RS-232 control
- Web pages

In auto mode, the switching selection is performed based on either last connected or priority input.

In last connected mode, if the signal on the current input is lost, the **DIP-31** automatically selects the last connected input, (the delay depending on the configurable signal-lost timeout).

In priority mode, when the input sync signal is lost for any reason, the input with a live signal and next in priority is selected automatically, (the delay depending on the configurable signal-lost timeout). This priority is configurable; the default setting is HDMI 1 → HDMI 2 → PC.



In both last connected and priority modes, manually selecting an input (using the remote input selection switches or any of the above methods) overrides automatic selection.

6.2 Signal Loss and Unplugged Cable Timeouts

In both last connected and priority modes, when the input signal sync is lost (but the cable is not removed) there is a default delay (ten seconds for video, not applicable to the PC input, and five seconds for analog audio) before another input is automatically selected. When an input cable is removed, there is a delay before automatic switching takes place.

Both timeouts are configurable, (see [Section 8.1](#)).



Analog audio is not output when there is no display connected. If a display is connected analog audio is output even in the absence of a video signal.

6.3 Audio Signal Control

The Option DIP-switches 3 and 4 (see [Section 8.1](#)) control the manner in which audio is handled.

The following table describes which audio signal is embedded in the output.

Selected Video Input	HDMI Embedded Audio Detected	Analog Audio Detected	DIP-switch 3	DIP-switch 4	Audio on HDMI Output
VGA	N/A	Yes	N/A	N/A	Analog audio
VGA	N/A	No	N/A	N/A	No audio
HDMI	N/A	N/A	Manual	Embedded	Embedded audio
HDMI	N/A	N/A	Manual	Analog	Analog audio
HDMI	Yes	No	Auto	N/A	Embedded audio
HDMI	Yes	Yes	Auto	Embedded	Embedded audio
HDMI	Yes	Yes	Auto	Analog	Analog audio
HDMI	No	Yes	Auto	N/A	Analog audio
HDMI	No	No	Auto	N/A	No audio

When there is an audio signal but no video signal the output is a black video pattern in conjunction with the analog audio signal.

6.4 VGA Phase Shift

To minimize phase on the input VGA signal, the VGA sampling phase can be shifted using the following methods:

- A long press on the PC IN select button on the front panel.
Each long press steps the phase shift up one step, starting from 0 and going to 31. When set to 31, another long press steps the shift to 0
- A remote, contact-closure switch connected to pins 1 and G of the Remote terminal block.
Each long press steps the phase shift up one step, starting from 0 and going to 31. When set to 31, another long press steps the shift to 0
- Using the Web pages, (see [Section 0](#))
- Protocol 3000 commands over RS-232 (see [Section 12](#))

7 Operating the DIP-31

The **DIP-31** can be operated using any of the following methods:

- Front panel buttons
- Protocol 3000 command, (see [Section 12](#))
- Remote contact-closure switch, (see [Section 5.1](#))
- Web pages, (see [Section 9](#))

7.1 Locking the EDID

To lock the EDID and prevent the stored EDID (either default or read from a device) from being overwritten:

- Send a Protocol 3000 command, (see [Section 12](#))
- Use the Web pages, (see [Section 9](#))

7.2 Resetting the DIP-31

The **DIP-31** can be reset to factory default by either:

- Using the button on the rear panel
- Using the Web pages, (see [Section 9](#))

To perform a soft reset of the DIP-31:

- Briefly press the Reset button.
The device resets

To reset the DIP-31 to factory default parameters:

- Press and hold the Reset button for five seconds.
The device is reset to factory default parameters

7.3 Analog Audio Output Volume Control

The analog audio output volume can be controlled using the Web pages, (see [Section 0](#)) or via the remote, contact-closure switches connected to pins 3 and 4 of the Remote terminal block, (see [Section 5.1](#)).

The number of up/down volume steps per press is detailed in the table below.

Ramp	Volume Reading	Volume (dB)
1	100	0
1	99	-0.5
1	98	-1.0
1	97	-1.5
1	96	-2.0
1	...	(0.5 steps)
1	12	-44.0
1	11	-44.5
1	10	-45.0
1	9	-45.5
2	...	(2.0 steps)
2	8	-47.0
2	7	-49.0
2	6	-51.0
2	5	-53.0
2	4	-55.0
2	3	-57.0
2	2	-59.0
2	1	-61.0
2	0	-63.0

8 Configuring the DIP-31

8.1 Setting the Configuration DIP-switch

The 4-way DIP-switch provides the ability to configure a number of device functions. A switch that is down is on; a switch that is up is off. By default, all the switches are up (off).

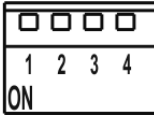

Figure 6: Configuration DIP-switch



After changing a DIP-switch you must power cycle the device to implement the change.

Video Switching Selection

DIP-switch 1	DIP-switch 2	Video Input Selection
Off (up)	Off (up)	Automatic—Last connected. Where more than one source is connected the last one connected has priority
Off (up)	On (down)	Automatic—Priority selection. HDMI 1 → HDMI 2 → PC IN (default, high to low priority)
On (down)	Off (up)	Manual
On (down)	On (down)	Manual

Audio Switching Selection

DIP-switch 3	DIP-switch 4	Audio Input Selection
Off (up)	Off (up)	Automatic—Priority selection. Embedded HDMI → analog Audio In (high to low priority)
Off (up)	On (down)	Automatic—Priority selection. Analog Audio In → embedded HDMI (high to low priority)
On (down)	Off (up)	Embedded HDMI
On (down)	On (down)	Analog Audio In

8.2 Switching Timeouts

When the **DIP-31** is configured for auto switching, the timeouts (before a new input is automatically selected) can be changed as shown in the tables below. (For the delay settings on the Web page, see [Section 9.4](#).) The following switching timeouts are only for HDMI and not VGA.

Timeout	Minimum Value	Default Value
Delay switching upon signal loss (signal off, 5V power on)	5 seconds	10 seconds for video input 5 Seconds for audio input
Delay switching upon cable unplug (signal off, power off)	0 seconds	0 seconds
Delay 5V power off upon signal loss (delay must be greater than "Delay switching upon signal loss")	Should at least equal the larger of the above two values (signal loss timeout and cable unplug timeout)	900 seconds

For example, if:

Delay switching upon signal loss = 15 seconds

Delay switching upon cable unplug = 30 seconds

Then:

Delay 5V power off upon signal loss must be ≥ 30 seconds

8.3 Using the Step-in Feature

To be able to use the Step-in feature, you need to assign the RS-232 signal that is transmitted over the HDMI link to control, (see [Section 9.2](#)). The Step-in button on the front panel now operates in conjunction with a compatible receiver, for example, the **VS-62H**).

9 Operating the DIP-31 Remotely Using the Web Pages

The **DIP-31** can be operated remotely using the embedded Web pages. The Web pages are accessed using a Web browser and an Ethernet connection.

Before attempting to connect:

- Ensure that your browser is supported (see [Section 10](#))
- Ensure that JavaScript is enabled



Note: The syntax of writing numbers with a prefix of zero is parsed as an octal number. For example, "0123" represents the decimal number 83.



Note: The Web pages work with a minimum resolution of 1024 x 768.

9.1 Browsing the DIP-31 Web Pages



In the event that a Web page does not update correctly, clear your Web browser's cache by pressing CTRL+F5.

To browse the DIP-31 Web pages:

1. Open your Internet browser.
2. Type the IP number of the device (see [Section 10.1](#)) in the Address bar of your browser.



If authentication is enabled, the following window appears ([Figure 7](#)) and you must enter the valid username (**Admin**) and password (**Admin**) to access the Web pages.

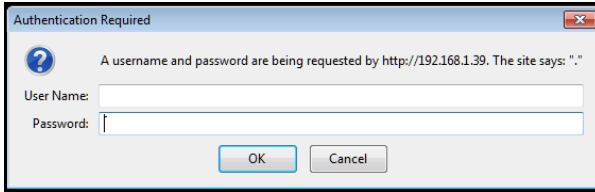

Figure 7: Entering Logon Credentials

Following a successful logon, the screen shown in [Figure 8](#) is displayed.

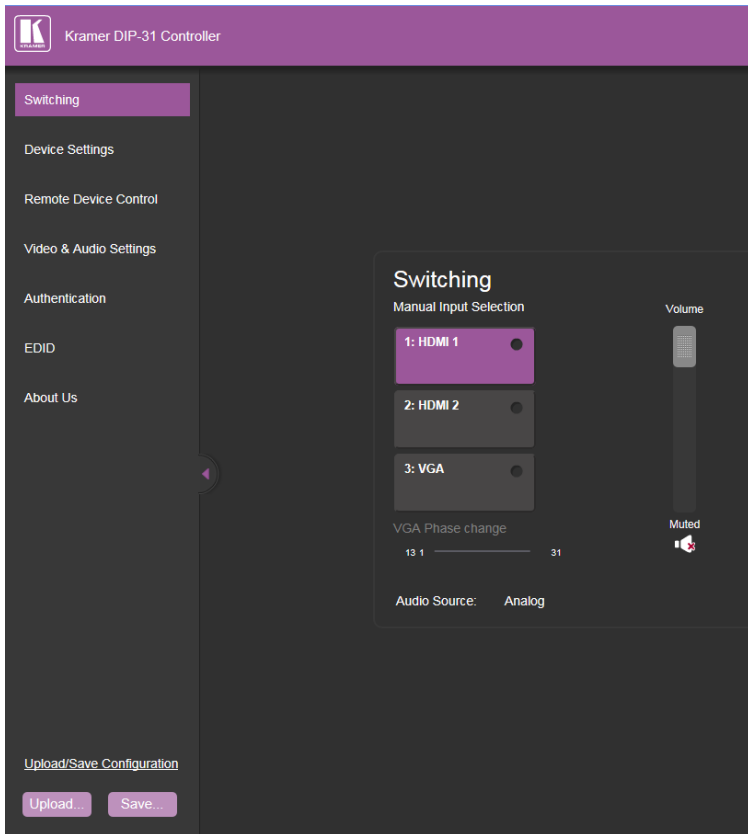

Figure 8: Default Page

To open the left hand side page panel, click the Reveal button ►.

The Switching page appears as shown in [Figure 9](#).

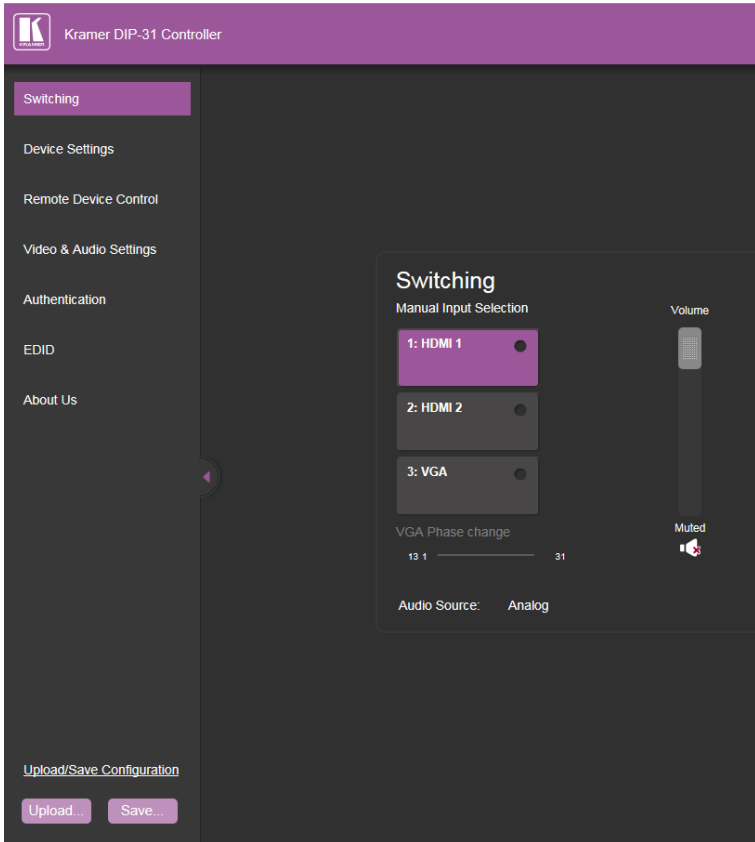

Figure 9: Main Switching Page

The areas of the main switching page are described in the following table.

Item	Description
Page Selection Panel	Click one of the buttons to select a page
Switching Selection	Switching and control section. Click one of the buttons to select a video input. Adjust the VGA phase shift. Adjust the audio volume. Select data routing mode
Hide/Reveal Button	Click to hide or reveal the page selection panel
Upload/Save Configuration Area	Click one of the buttons to save or retrieve a configuration, (see Section 9.1.1)

There are six Web pages described in the following sections:

- Switching (see [Section 9.2](#))
- Device Settings (see [Section 9.3](#))
- Video and Audio Settings (see [Section 9.4](#))
- Authentication (see [Section 9.6](#))
- EDID (see [Section 9.7](#))
- About Us (see [Section 9.8](#))

9.1.1 Upload/Save Configuration Facility

The Upload/Save Configuration facility (see item 4 in [Figure 9](#)) lets you retrieve and save a configuration.

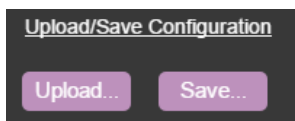

To upload a configuration:

1. Click the Upload button.
The File Upload browser window appears.
2. Browse to the required file and press Open.
The configuration is retrieved and the success message is displayed.

To save the current configuration:

1. Click the Save button.
The Save Configuration success message is displayed.
2. Do either of the following:
 - Click Download to either open the file or save it to the required location
 - Or, click OK to complete the procedure

9.2 Switching Page

The Switching page lets you select a video input manually and adjust the audio volume.

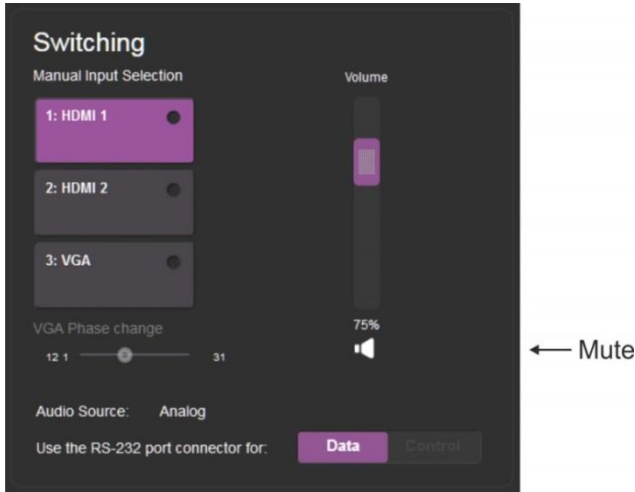

Figure 10: Switching Page

Item	Description
<i>HDMI 1</i> Button	Click to select the HDMI 1 input. The button color indicates whether or not there is a live signal on the input
<i>HDMI 2</i> Button	Click to select the HDMI 2 input
<i>VGA</i> Button	Click to select the VGA input
<i>VGA Phase Change</i> Slider	Click and slide to the left or right to adjust the VGA phase change
<i>Audio Source</i> : Indicator	Indicates the source of the audio that is transmitted on the output
<i>Use the RS-232 port connector for</i> : Button	Assigns the use of the RS-232 signal over HDMI to either data or control: <ul style="list-style-type: none"> <i>Data</i> for passive mode to route RS-232 traffic transparently <i>Control</i> for active mode to route RS-232 commands to the microprocessor to control the DIP-31, (mandatory when the step-in function is required)
<i>Volume</i> Slider	Click and slide up and down to increase or decrease the audio output volume
<i>Mute</i> Button	Click to mute or unmute the output audio



To be able to use the Step-in feature, you must assign the RS-232 signal that is transmitted over the HDMI link to *Control*. The Step-in button on the front panel now operates in conjunction with a compatible receiver, for example, the **VS-62H**).

9.3 Device Settings Page

The Device Settings page lets you:

- View some of the device characteristics, (for example, model and Web version)
- Edit IP settings, (for example, name and IP address)
- Upgrade the firmware
- Reset the device to factory default settings



After making any change to the parameters on the Device Settings page, you must power cycle the device to activate the changes.

The screenshot shows the 'Device Settings' page with a dark background. It is divided into three main sections: Information, Settings, and Firmware Upgrade.

Information	
Model	DIP-31
Serial Number	12345678901234
Firmware Version	1.15.29904
Web Version	2.0.16
MAC Address	11-11-11-11-11-11

Settings	
DNS Name	<input type="text" value="KRAMER_"/> <input type="button" value="SET"/>
DHCP	<input type="radio" value="ON"/> <input checked="" type="radio" value="OFF"/>
IP Address	<input type="text" value="192.168.1.39"/> <input type="button" value="SET"/>
Mask	<input type="text" value="255.255.0.0"/> <input type="button" value="SET"/>
Gateway	<input type="text" value="192.168.0.1"/> <input type="button" value="SET"/>
TCP Port	<input type="text" value="5000"/> <input type="button" value="SET"/>
UDP Port	<input type="text" value="50000"/> <input type="button" value="SET"/>

Firmware Upgrade	
Choose a file	
<input type="button" value="BROWSE..."/>	
<input type="button" value="START UPGRADE"/>	
Reset	
<input type="button" value="FACTORY RESET"/>	

Figure 11: Device Settings Page

Item		Description
Information Section		Displays information regarding the device, such as, the model, serial number, and MAC address
DNS name		The DNS name of the device. To set a new name, enter the new alphanumeric name and click Set. (For restrictions regarding the name, see Section 10.2)
DHCP Buttons		Click ON to turn DHCP on; click OFF to turn DHCP off and use static IP addressing
IP address		The IP address of the device. To set a new IP address, enter the new valid IP address and click Set
Mask		The network mask of the device. To set a new mask, enter the new valid mask and click Set
Gateway		The network gateway for the device. To set a new network gateway, enter the new valid gateway and click Set
TCP Port		The TCP port number of the device. To set a new TCP port number, enter the new valid port number or use the spin controls and click Set
UDP Port		The UDP port number of the device. To set a new UDP port number, enter the new valid port number or use the spin controls and click Set
Firmware upgrade Section	BROWSE button	Click to open a window to browse to the new firmware file
	START UPGRADE button	Click to start the upgrade process following the selection of the new firmware file
Factory Reset Button		Click to reset the device to factory default parameters. After the success message is displayed, power cycle the device
Set Button		Click to store a changed parameter. Note: If you do not click the Set button, the new parameter is not stored

To upgrade the firmware:

1. Click **Browse**.
The Windows Browser opens.
2. Browse to the required file.
3. Select the required file and click **Open**.
The firmware file name is displayed in the Firmware Upgrade page.
4. Click **Start Upgrade**.
The firmware file is loaded and a progress bar is displayed.



Do not interrupt the process or the **DIP-31** may be damaged.

- When the process is complete reboot the device.
The firmware is upgraded.

To reset the DIP-31 to factory default parameters:

- Click the **Factory Reset** button.
The confirmation message is displayed.
- Click **OK** to continue or **Cancel** to exit the procedure.
- Click **OK**.
The progress message is displayed.
On completion, the success message is displayed.
- Click **OK**.

9.4 Remote Device Control Page

The RS-232 DATA port (not the control port) can be used for data, P3K control commands or external device control.

Opening the Remote Device Control page allows you to configure the RS-232 data port (parity, data bits, baud rate and stop bits). It also allows you to enable and disable power commands to a remote peripheral device as well as specifying predefined triggers (5V on – connect, 5V off – disconnect) with defined delays as illustrated:

Remote Device Control

RS-232 Configuration

Parity NONE

Data bits 8

Baud rate 9600

Stops bits 1

Remote Device commands configuration

Enabled	Edit	Test	Trigger	Description	Delay	Command
<input checked="" type="checkbox"/>			5V On	power on	2	turn on device
<input type="checkbox"/>			5V Off	power off	30	turn off device

CANCEL
APPLY

To define trigger delays, click the pencil icon under Edit. The following window opens (also for power off):

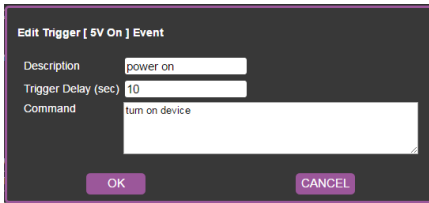

All fields can be changed as required. Trigger delay can be specified from 0 to 60000 seconds with a default value of 10 seconds.

9.5 Video and Audio Settings Page

The Video and Audio Settings page lets you modify the video, audio and timeout parameters.

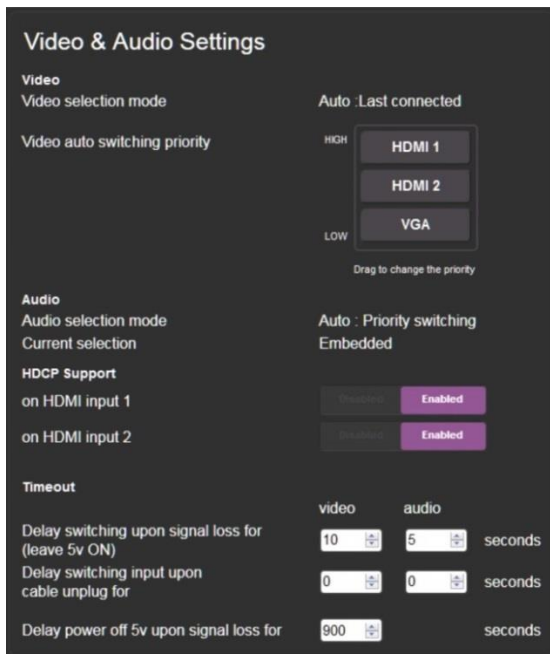

Figure 12: Video and Audio Settings Page

Item	Description
<i>Video selection mode</i> Indicator	Indicates the current video selection mode; manual, auto, or auto last connected
<i>Video auto switching priority</i> Buttons	Click and drag the buttons to the required priority level to use when in auto mode
<i>Audio selection mode</i> Indicator	Indicates the current audio selection; manual, auto, or auto last connected
<i>Current selection</i> Audio Indicator	Indicates the current audio selection; Embedded or analog
<i>HDCP Support</i> (on HDMI input) Buttons	Select HDCP support for HDMI 1 and HDMI 2 Disabled—HDCP encrypted content is not passed Enabled—HDCP support is dictated by the display
<i>Delay switching upon signal loss for (leave 5V on)</i> Box	Sets the delay for video and audio before switching (in auto mode) because of a signal loss on the currently selected input. Value in seconds (see Section 6.2)
<i>Delay switching input upon cable unplug for</i> Box	Sets the delay for video and audio before switching (in auto mode) because the currently selected input cable is unplugged. Value in seconds (see Section 6.2)
<i>Delay power off 5V upon signal loss for</i> Box	Sets the delay for turning off the 5V output because of a signal loss on the currently selected input. Value in seconds (see Section 6.2)

9.6 Authentication Page

The Authentication page lets you assign or change logon authentication details.

The screenshot shows a dark-themed web interface for authentication. At the top, the title "Authentication" is displayed. Below it, there is a toggle switch for "Activate Security" which is currently set to "ON". Underneath, there are three input fields for "Change Password": "Current Password", "New Password", and "Retype New password". A purple "CHANGE" button is located at the bottom of the form.

Figure 13: Authentication Page

Item		Description
Activate Security Button		Click to enable/disable security settings. When enabled, the valid username and password must be provided to allow Web page access
Change Password	Current Password box	Enter the current password
	New Password box	Enter the new password, (up to 15 printable ASCII characters)
	Retype New Password box	Retype the new password
CHANGE button		Click CHANGE to save the new authentication details

9.7 EDID Page

The EDID page lets you copy EDID data to one or more of the inputs from the following sources:

- Output
- Input
- Default EDID
- EDID data file

From this page you can also lock the EDID on each input independently.

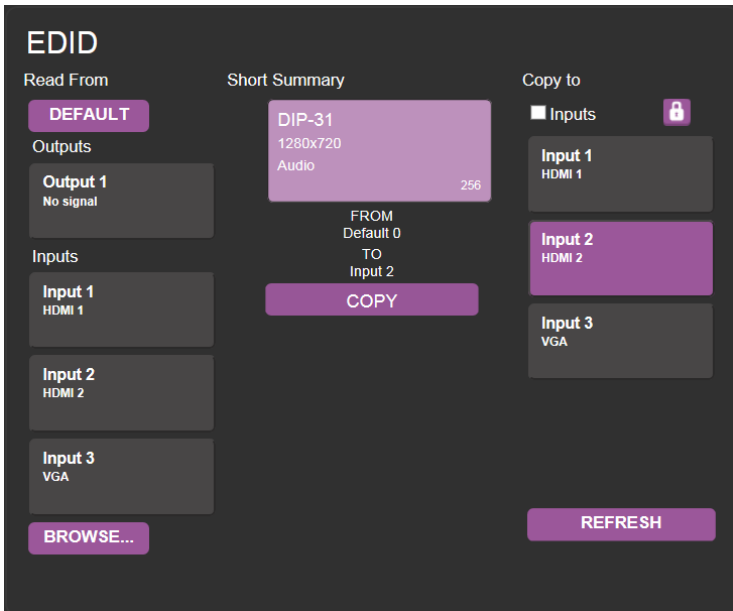

Figure 14: EDID Page



The display is not updated automatically when the status of an EDID changes on the device caused by outputs being exchanged. Click Refresh to update the display (see final item in the following table).

Item		Description
<i>Read from Section</i>	<i>DEFAULT</i> EDID button	Click to read the default EDID
	<i>Output 1</i> button	Click to read the EDID from output 1
	<i>Input 1</i> button	Click to read the EDID from input 1 (HDMI 1)
	<i>Input 2</i> button	Click to read the EDID from input 2 (HDMI 2)
	<i>Input 3</i> button	Click to read the EDID from input 3 (VGA)
	<i>BROWSE</i> button	Click to open the file browser to select an EDID file on your computer
<i>Short Summary Information Section</i>		Displays the current election of EDID source, destination, video resolution, audio availability, and status
<i>Copy to Section</i>	<i>Inputs</i> selection box	Check to select both inputs
	Lock button	Locks the EDID on the currently selected input
	<i>Input 1</i> button	Click to select input 1 as the destination (HDMI 1)
	<i>Input 2</i> button	Click to select input 2 as the destination (HDMI 2)
	<i>Input 3</i> button	Click to select input 3 as the destination (VGA)
<i>COPY</i> Button		Click to copy the EDID from the selected source to the selected destination
<i>REFRESH</i> Button		Click to refresh the display

To copy EDID data from a source to one or both inputs:

1. Click the source button from which to read the EDID (default, output, input, or EDID file).
The button changes color and the EDID summary information reflects the selection and EDID data.
2. Click a destination input, or select all inputs by checking the Inputs checkbox.
All selected input buttons change color and the EDID summary information reflects the selection and EDID data.
3. Click **Copy**.
The “EDID was copied” success message is displayed and the EDID data is copied to the selected input(s).
4. Click **OK**.

9.8 About Us Page

The **DIP-31** About Us page displays the Web page version and Kramer Electronics Ltd company details.



Figure 15: About Us Page

10 Technical Specifications

INPUTS:	Video:	2 HDMI on HDMI connectors 1 VGA on a 15-pin HD (F) connector
	Audio:	1 Unbalanced stereo audio 1V RMS (nominal) on a 3.5mm mini jack
OUTPUTS:	Video:	1 HDMI on an HDMI connector
	Audio:	1 Unbalanced stereo audio 1V RMS (nominal) on a 3.5mm mini jack
PORTS:	1 Ethernet on an RJ-45 connector 1 RS-232 3-pin terminal block control port 1 RS-232 3-pin terminal block data port 1 USB on mini USB connector	
CONTROLS:	Remote switches for input switching, step-in, volume control, and device reset switch	
STANDARDS:	HDMI with Deep Color, x.v.Color™ and 3D HDCP—works with sources that support HDCP repeater mode	
MAXIMUM ANALOG AUDIO LEVELS:	3.1V p-p	
THD:	0.013%	
SNR:	75dB	
SUPPORTED WEB BROWSERS:	<p>Windows 7 and higher:</p> <ul style="list-style-type: none"> • Internet Explorer (32/64 bit) version 11 • Firefox version 30 • Chrome version 35 <p>MAC:</p> <ul style="list-style-type: none"> • Chrome version 35 • Firefox version 27 • Safari version 7 <p>Android OS:</p> <ul style="list-style-type: none"> • Chrome version 35 <p>iOS:</p> <ul style="list-style-type: none"> • Chrome version 35 • Safari version 7 	
POWER CONSUMPTION:	12V DC, 600mA	
OPERATING TEMPERATURE:	0° to +40°C (32° to 104°F)	
STORAGE TEMPERATURE:	-40° to +70°C (-40° to 158°F)	
HUMIDITY:	10% to 90%, RHL non-condensing	
COOLING:	Convection	
ENCLOSURE TYPE:	Aluminum	
DIMENSIONS:	18.75cm x 11.5cm x 2.54cm (7.38" x 4.53" x 1.0") W, D, H	
WEIGHT:	0.43kg (0.95lbs) approx.	
SHIPPING DIMENSIONS:	34.5cm x 16.5cm x 5.2cm (13.6" x 6.5" x 2.0") W, D, H	
SHIPPING WEIGHT:	1.03kg (2.3lbs) approx.	

ENVIRONMENTAL REGULATORY COMPLIANCE:	Complies with appropriate requirements of RoHs and WEEE
INCLUDED ACCESSORIES:	Power adapter ADC-DPM/HF DisplayPort (M) to HDMI (F) adapter cable, (for connecting a DisplayPort source to the HDMI input)
OPTIONS:	Rack adapter RK-T2B
WARRANTY:	7 years parts and labor

10.1 Default IP Parameters

Parameter	Values	Default
Device Name	Any alphanumeric string up to 14 chars (can include hyphen, but not at the beginning or end)	KRAMER_
DHCP	ON/OFF	OFF
IP Address	Any valid IP address	192.168.1.39
Mask	Any valid network mask	255.255.0.0
Gateway	Any valid gateway address	192.168.0.1
TCP Port	0 to 65535	5000
UDP Port	0 to 65535	50000

10.2 Default Logon Credentials

Parameter	Values
Name	Admin
Password	Admin

10.3 Supported HDMI Resolutions

Resolution	Refresh Rate (Hz)
640x480p	85Hz; 75Hz; 72Hz; 60Hz; 59.95Hz
720x480p	60Hz
720x480i	30Hz
720x576p	50Hz
800x600p	85Hz; 75Hz; 72Hz; 60Hz
848x480p	60Hz
852x480p	60Hz
1024x768p	85Hz; 75Hz; 70Hz; 60Hz
1152x864p	75Hz
1280x768p	60Hz
1280x800p	60Hz
1280x960	60Hz

Resolution	Refresh Rate (Hz)
1280x1024p	75Hz; 60Hz
1360x768p	60Hz
1366x768	60Hz; 50Hz
1400x1050p	60Hz
1440x900p	60Hz
1600x900p	60Hz
1600x1200p	60Hz
1680x1050p	60Hz
1920x1080p	50Hz; 60Hz; 30Hz; 24Hz;
1920x1080i	50Hz; 60Hz;
3840x2160	30Hz
4096x2160	30Hz

10.4 Supported VGA Resolutions

Resolution	Refresh Rate
640x480p	60Hz
720x480p	60Hz
800x600p	60Hz
848x480p	60Hz
1024x768p	60Hz
1152x864	75Hz
1280x720p	60Hz; 50Hz
1280x768	60Hz
1280x800	60Hz
1280x960p	60Hz
1280x1024p	60Hz
1360x768	60Hz;
1366x768	60Hz; 50Hz
1400x1050	60Hz
1440x900	60Hz
1920x1080p	60Hz
1920x1200	60Hz; 50Hz

11 Default EDID

Each input on the **DIP-31** is loaded with a factory default EDID.

11.1 HDMI

Monitor

Model name.....DIP-31
Manufacturer..... KMR
Plug and Play ID..... KMR1200
Serial number..... n/a
Manufacture date..... 2015, ISO week 255
Filter driver..... None

EDID revision..... 1.3
Input signal type..... Digital
Color bit depth..... Undefined
Display type..... RGB color
Screen size..... 520 x 320 mm (24.0 in)
Power management..... Standby, Suspend, Active off/sleep
Extension blocs..... 1 (CEA-EXT)

DDC/CI..... n/a

Color characteristics

Default color space..... Non-sRGB
Display gamma..... 2.20
Red chromaticity..... Rx 0.674 - Ry 0.319
Green chromaticity..... Gx 0.188 - Gy 0.706
Blue chromaticity..... Bx 0.148 - By 0.064
White point (default)... Wx 0.313 - Wy 0.329
Additional descriptors... None

Timing characteristics

Horizontal scan range.... 30-83kHz
Vertical scan range..... 56-76Hz
Video bandwidth..... 170MHz
CVT standard..... Not supported
GTF standard..... Not supported
Additional descriptors... None
Preferred timing..... Yes
Native/preferred timing.. 1280x720p at 60Hz (16:10)
Modeline..... "1280x720" 74.250 1280 1390 1430 1650 720 725 730 750 +hsync +vsync

Standard timings supported

720 x 400p at 70Hz - IBM VGA
720 x 400p at 88Hz - IBM XGA2
640 x 480p at 60Hz - IBM VGA
640 x 480p at 67Hz - Apple Mac II
640 x 480p at 72Hz - VESA
640 x 480p at 75Hz - VESA
800 x 600p at 56Hz - VESA
800 x 600p at 60Hz - VESA
800 x 600p at 72Hz - VESA
800 x 600p at 75Hz - VESA
832 x 624p at 75Hz - Apple Mac II
1024 x 768i at 87Hz - IBM
1024 x 768p at 60Hz - VESA
1024 x 768p at 70Hz - VESA
1024 x 768p at 75Hz - VESA
1280 x 1024p at 75Hz - VESA
1152 x 870p at 75Hz - Apple Mac II
1280 x 1024p at 75Hz - VESA STD
1280 x 1024p at 85Hz - VESA STD
1600 x 1200p at 60Hz - VESA STD
1024 x 768p at 85Hz - VESA STD

800 x 600p at 85Hz - VESA STD
640 x 480p at 85Hz - VESA STD
1152 x 864p at 70Hz - VESA STD
1280 x 960p at 60Hz - VESA STD

EIA/CEA-861 Information

Revision number..... 3
IT underscan..... Supported
Basic audio..... Supported
YCbCr 4:4:4..... Supported
YCbCr 4:2:2..... Supported
Native formats..... 1
Detailed timing #1..... 1920x1080p at 60Hz (16:10)
 Modeline..... "1920x1080" 148.500 1920 2008 2052 2200 1080 1084 1089 1125 +hsync +vsync
Detailed timing #2..... 1920x1080i at 60Hz (16:10)
 Modeline..... "1920x1080i" 74.250 1920 2008 2052 2200 1080 1084 1094 1124 interlace +hsync
+vsync
Detailed timing #3..... 1280x720p at 60Hz (16:10)
 Modeline..... "1280x720" 74.250 1280 1390 1430 1650 720 725 730 750 +hsync +vsync
Detailed timing #4..... 720x480p at 60Hz (16:10)
 Modeline..... "720x480" 27.000 720 736 798 858 480 489 495 525 -hsync -vsync

CE audio data (formats supported)

LPCM 2-channel, 16/20/24 bit depths at 32/44/48 kHz

CE video identifiers (VICs) - timing/formats supported

1920 x 1080p at 60Hz - HDTV (16:9, 1:1)
1920 x 1080i at 60Hz - HDTV (16:9, 1:1)
1280 x 720p at 60Hz - HDTV (16:9, 1:1) [Native]
720 x 480p at 60Hz - EDTV (16:9, 32:27)
720 x 480p at 60Hz - EDTV (4:3, 8:9)
720 x 480i at 60Hz - Doublescan (16:9, 32:27)
720 x 576i at 50Hz - Doublescan (16:9, 64:45)
640 x 480p at 60Hz - Default (4:3, 1:1)
NB: NTSC refresh rate = (Hz*1000)/1001

CE vendor specific data (VSDb)

IEEE registration number. 0x000C03
CEC physical address..... 1.0.0.0
Maximum TMDS clock..... 165MHz

CE speaker allocation data

Channel configuration.... 2.0
Front left/right..... Yes
Front LFE..... No
Front center..... No
Rear left/right..... No
Rear center..... No
Front left/right center.. No
Rear left/right center... No
Rear LFE..... No

Report information

Date generated..... 09/08/2015
Software revision..... 2.60.0.972
Data source..... File
Operating system..... 6.1.7601.2.Service Pack 1

Raw data

00,FF,FF,FF,FF,FF,FF,00,2D,B2,00,12,00,00,00,00,FF,19,01,03,80,34,20,78,EA,B3,25,AC,51,30,B4,26,
10,50,54,FF,FF,80,81,8F,81,99,A9,40,61,59,45,59,31,59,71,4A,81,40,01,1D,00,72,51,D0,1E,20,6E,28,
55,00,07,44,21,00,00,1E,00,00,00,FD,00,38,4C,1E,53,11,00,0A,20,20,20,20,20,20,00,00,00,FC,00,41,
56,53,2D,33,32,20,20,20,20,20,20,20,00,00,00,00,00,00,00,00,00,00,00,00,00,00,00,00,01,B7,
02,03,1B,F1,23,09,07,07,48,10,05,84,03,02,07,16,01,65,03,0C,00,10,00,83,01,00,00,02,3A,80,18,71,
38,2D,40,58,2C,45,00,07,44,21,00,00,1E,01,1D,80,18,71,1C,16,20,58,2C,25,00,07,44,21,00,00,9E,01,
1D,00,72,51,D0,1E,20,6E,28,55,00,07,44,21,00,00,1E,8C,0A,D0,8A,20,E0,2D,10,10,3E,96,00,07,44,21,
00,00,18,00,47

11.2 PC-UXGA

Monitor

Model name..... DIP-31
Manufacturer..... KMR
Plug and Play ID..... KMR1200
Serial number..... n/a
Manufacture date..... 2015, ISO week 255
Filter driver..... None

EDID revision..... 1.3
Input signal type..... Analog 0.700,0.000 (0.7V p-p)
Sync input support..... Separate, Composite, Sync-on-green
Display type..... RGB color
Screen size..... 520 x 320 mm (24.0 in)
Power management..... Standby, Suspend, Active off/sleep
Extension blocs..... None

DDC/CI..... n/a

Color characteristics

Default color space..... sRGB
Display gamma..... 2.20
Red chromaticity..... Rx 0.674 - Ry 0.319
Green chromaticity..... Gx 0.188 - Gy 0.706
Blue chromaticity..... Bx 0.148 - By 0.064
White point (default).... Wx 0.313 - Wy 0.329
Additional descriptors... None

Timing characteristics

Horizontal scan range.... 30-83kHz
Vertical scan range..... 56-76Hz
Video bandwidth..... 170MHz
CVT standard..... Not supported
GTF standard..... Not supported
Additional descriptors... None
Preferred timing..... Yes
Native/preferred timing.. 1280x720p at 60Hz (16:10)
Modeline..... "1280x720" 74.250 1280 1390 1430 1650 720 725 730 750 +hsync +vsync

Standard timings supported

720 x 400p at 70Hz - IBM VGA
720 x 400p at 88Hz - IBM XGA2
640 x 480p at 60Hz - IBM VGA
640 x 480p at 67Hz - Apple Mac II
640 x 480p at 72Hz - VESA
640 x 480p at 75Hz - VESA
800 x 600p at 56Hz - VESA
800 x 600p at 60Hz - VESA
800 x 600p at 72Hz - VESA
800 x 600p at 75Hz - VESA
832 x 624p at 75Hz - Apple Mac II
1024 x 768i at 87Hz - IBM
1024 x 768p at 60Hz - VESA
1024 x 768p at 70Hz - VESA
1024 x 768p at 75Hz - VESA
1280 x 1024p at 75Hz - VESA
1152 x 870p at 75Hz - Apple Mac II
1280 x 1024p at 75Hz - VESA STD
1280 x 1024p at 85Hz - VESA STD
1600 x 1200p at 60Hz - VESA STD
1024 x 768p at 85Hz - VESA STD
800 x 600p at 85Hz - VESA STD
640 x 480p at 85Hz - VESA STD
1152 x 864p at 70Hz - VESA STD
1280 x 960p at 60Hz - VESA STD

EIA/CEA-861 Information

Revision number..... 3
IT underscan..... Supported

Basic audio..... Supported
 YCbCr 4:4:4..... Supported
 YCbCr 4:2:2..... Supported
 Native formats..... 1
 Detailed timing #1..... 1920x1080p at 60Hz (16:10)
 Modeline..... "1920x1080" 148.500 1920 2008 2052 2200 1080 1084 1089 1125 +hsync +vsync
 Detailed timing #2..... 1920x1080i at 60Hz (16:10)
 Modeline..... "1920x1080i" 74.250 1920 2008 2052 2200 1080 1084 1094 1124 interlace +hsync
 +vsync
 Detailed timing #3..... 1280x720p at 60Hz (16:10)
 Modeline..... "1280x720" 74.250 1280 1390 1430 1650 720 725 730 750 +hsync +vsync
 Detailed timing #4..... 720x480p at 60Hz (16:10)
 Modeline..... "720x480" 27.000 720 736 798 858 480 489 495 525 -hsync -vsync

CE audio data (formats supported)
 LPCM 2-channel, 16/20/24 bit depths at 32/44/48 kHz

CE video identifiers (VICs) - timing/formats supported
 1920 x 1080p at 60Hz - HDTV (16:9, 1:1)
 1920 x 1080i at 60Hz - HDTV (16:9, 1:1)
 1280 x 720p at 60Hz - HDTV (16:9, 1:1) [Native]
 720 x 480p at 60Hz - EDTV (16:9, 32:27)
 720 x 480p at 60Hz - EDTV (4:3, 8:9)
 720 x 480i at 60Hz - Doublescan (16:9, 32:27)
 720 x 576i at 50Hz - Doublescan (16:9, 64:45)
 640 x 480p at 60Hz - Default (4:3, 1:1)
 NB: NTSC refresh rate = (Hz*1000)/1001

CE vendor specific data (VSDb)
 IEEE registration number. 0x000C03
 CEC physical address..... 1.0.0.0
 Maximum TMDS clock..... 165MHz

CE speaker allocation data
 Channel configuration.... 2.0
 Front left/right..... Yes
 Front LFE..... No
 Front center..... No
 Rear left/right..... No
 Rear center..... No
 Front left/right center... No
 Rear left/right center... No
 Rear LFE..... No

Report information
 Date generated..... 09/08/2015
 Software revision..... 2.60.0.972
 Data source..... File
 Operating system..... 6.1.7601.2.Service Pack 1

Raw data
 00,FF,FF,FF,FF,FF,FF,00,2D,B2,00,12,00,00,00,00,FF,19,01,03,6E,34,20,78,EE,B3,25,AC,51,30,B4,26,
 10,50,54,FF,FF,80,81,8F,81,99,A9,40,61,59,45,59,31,59,71,4A,81,40,01,1D,00,72,51,D0,1E,20,6E,28,
 55,00,07,44,21,00,00,1E,00,00,00,FD,00,38,4C,1E,53,11,00,0A,20,20,20,20,20,20,00,00,00,FC,00,41,
 56,53,2D,33,32,20,20,20,20,20,20,20,00,
 02,03,1B,F1,23,09,07,07,48,10,05,84,03,02,07,16,01,65,03,0C,00,10,00,83,01,00,00,02,3A,80,18,71,
 38,2D,40,58,2C,45,00,07,44,21,00,00,1E,01,1D,80,18,71,1C,16,20,58,2C,25,00,07,44,21,00,00,9E,01,
 1D,00,72,51,D0,1E,20,6E,28,55,00,07,44,21,00,00,1E,8C,0A,D0,8A,20,E0,2D,10,10,3E,96,00,07,44,21,
 00,00,18,00,47

12 Protocol 3000

The **DIP-31 Automatic Video Switcher** can be operated using the Kramer Protocol 3000 serial commands. The command framing varies according to how you interface with the **DIP-31**. For example, a basic video input switching command that routes a layer 1 video signal to HDMI out 1 from HDMI input 2 (`ROUTE 1, 1, 2`), is entered as follows:

- Terminal communication software, such as Hercules:

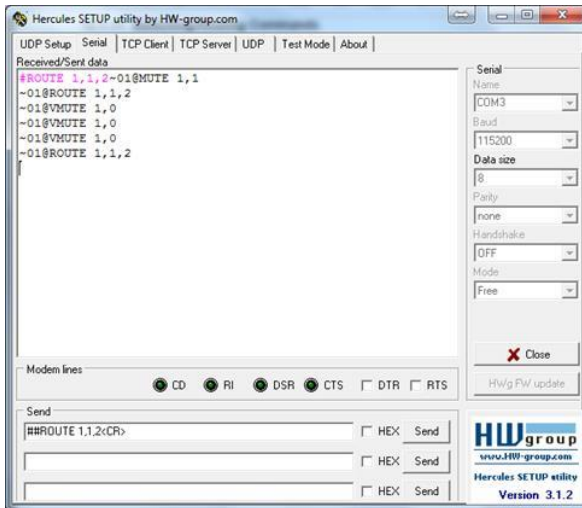

The framing of the command varies according to the terminal communication software.

- K-Touch Builder (Kramer software):

'Device Code (17)' PROPERTIES	
name	Device Code (17)
data	#ROUTE 1,1,2x0D

- K-Config (Kramer configuration software):

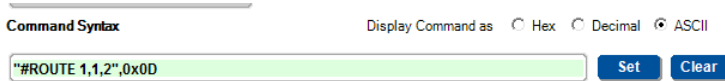

All the examples provided in this section are based on using the K-Config software.

You can enter commands directly using terminal communication software (e.g., Hercules) by connecting a PC to the serial or Ethernet port on the **DIP-31**. To enter `CR` press the Enter key (`LF` is also sent but is ignored by the command parser).

Commands sent from various non-Kramer controllers (e.g., Crestron) may require special coding for some characters (such as, `/x##`). For more information, refer to your controller's documentation.

For more information about:

- Using Protocol 3000 commands, see [Section 12.1](#)
- General syntax used for Protocol 3000 commands, see [Section 12.2](#)
- Protocol 3000 commands available for the **DIP-31**, see [Section 12.3](#)

12.1 Understanding Protocol 3000

Protocol 3000 commands are structured according to the following:

- **Command** – A sequence of ASCII letters (`A-Z`, `a-z` and `-`). A command and its parameters must be separated by at least one space.
- **Parameters** – A sequence of alphanumeric ASCII characters (`0-9`, `A-Z`, `a-z` and some special characters for specific commands). Parameters are separated by commas.
- **Message string** – Every command entered as part of a message string begins with a message starting character and ends with a message closing character.



A string can contain more than one command. Commands are separated by a pipe (|) character.

The maximum string length is 64 characters.

- **Message starting character:**
 - # – For host command/query
 - ~ – For device response
- **Device address** – K-NET Device ID followed by @ (optional, K-NET only)
- **Query sign** -? follows some commands to define a query request
- **Message closing character:**
 - CR – Carriage return for host messages (ASCII 13)
 - CR LF – Carriage return for device messages (ASCII 13) and line-feed (ASCII 10)
- **Command chain separator character** – Multiple commands can be chained in the same string. Each command is delimited by a pipe character (|). When chaining commands, enter the message starting character and the message closing character only at the beginning and end of the string.



Spaces between parameters or command terms are ignored. Commands in the string do not execute until the closing character is entered. A separate response is sent for every command in the chain.

12.2 Kramer Protocol 3000 Syntax

The Kramer Protocol 3000 syntax uses the following delimiters:

- **CR** = Carriage return (ASCII 13 = 0x0D)
- **LF** = Line feed (ASCII 10 = 0x0A)
- **SP** = Space (ASCII 32 = 0x20)

Some commands have short name syntax in addition to long name syntax to enable faster typing. The response is always in long syntax.

The Protocol 3000 syntax is in the following format:

- Host Message Format:

Start	Address (optional)	Body	Delimiter
#	<i>Device_id@</i>	Message	CR

- **Simple Command** – Command string with only one command without addressing:

Start	Body	Delimiter
#	Command SP <i>Parameter_1,Parameter_2,...</i>	CR

- **Command String** – Formal syntax with command concatenation and addressing:

Start	Address	Body	Delimiter
#	<i>Device_id@</i>	Command_1 <i>Parameter1_1,Parameter1_2,...</i> Command_2 <i>Parameter2_1,Parameter2_2,...</i> Command_3 <i>Parameter3_1,Parameter3_2,...</i> ...	CR

- Device Message Format:

Start	Address (optional)	Body	Delimiter
~	<i>Device_id@</i>	Message	CR LF

- Device Long Response – Echoing command:

Start	Address (optional)	Body	Delimiter
~	<i>Device_id@</i>	Command SP [<i>Param1 ,Param2 ...</i>] result	CR LF

12.3 Protocol 3000 Commands

This section includes the following commands:

- System Commands (see [Section 12.3.1](#))
- Authentication Commands (see [Section 12.3.2](#))
- Switching/Routing Commands (see [Section 12.3.3](#))
- Video Commands (see [Section 12.3.4](#))
- Audio Commands (see [Section 12.3.5](#))
- Communication Commands (see [Section 12.3.6](#))
- EDID Handling Commands (see [Section 12.3.7](#))

12.3.1 System Commands

Command	Description
#	Protocol handshaking (system mandatory)
BUILD-DATE	Get device build date (system mandatory)
FACTORY	Reset to factory default configuration
HELP	Get command list (system mandatory)
MODEL	Get device model (system mandatory)
PROT-VER	Get device protocol version (system mandatory)
RESET	Reset device (system mandatory)
SN	Get device serial number (system mandatory)
VERSION	Get device firmware version (system mandatory)
AV-SW-MODE	Set/get auto switch mode (system)
AV-SW-TIMEOUT	Set/get auto switching timeout (system)
DISPLAY	Get output HPD status (system)
DPSW-STATUS	Get the DIP-switch status (system)
FPGA-VER	Get current FPGA version (system)
HDCP-MOD	Set/get HDCP mode (system)
HDCP-STAT	Get HDCP signal status (system)
NAME	Set/get machine (DNS) name (system – Ethernet)
NAME-RST	Reset machine (DNS) name to factory default (system – Ethernet)
PRIORITY	Set/get priority for all channels (system)
SIGNAL	Get input signal lock status (system)

12.3.1.1

Functions		Permission	Transparency
Set:	#	End User	Public
Get:	-	-	-
Description		Syntax	
Set:	Protocol handshaking	# <code>CR</code>	
Get:	-	-	
Response			
~ <code>nn</code> @ <code>SF</code> <code>OK</code> <code>CR LF</code>			
Parameters			
Response Triggers			
Notes			
Validates the Protocol 3000 connection and gets the machine number Step-in master products use this command to identify the availability of a device			
K-Config Example			
`#", 0x0D			

12.3.1.2 BUILD-DATE

Functions		Permission	Transparency
Set:	-	-	-
Get:	BUILD-DATE?	End User	Public
Description		Syntax	
Set:	-	-	
Get:	Get device build date	# BUILD-DATE? <code>CR</code>	
Response			
~ <code>nn</code> @ BUILD-DATE <code>SF</code> <code>date</code> <code>SF</code> <code>time</code> <code>CR LF</code>			
Parameters			
<i>date</i> – Format: YYYY/MM/DD where YYYY = Year, MM = Month, DD = Day <i>time</i> – Format: hh:mm:ss where hh = hours, mm = minutes, ss = seconds			
Response Triggers			
Notes			
K-Config Example			
`#BUILD-DATE?", 0x0D			

12.3.1.3 FACTORY

Functions		Permission	Transparency
Set:	FACTORY	End User	Public
Get:	-	-	-
Description		Syntax	
Set:	Reset device to factory default configuration	#FACTORY <code>CR</code>	
Get:	-	-	
Response			
~nn@FACTORY <code>SE</code> OK <code>CR LF</code>			
Parameters			
Response Triggers			
Notes			
This command deletes all user data from the device. The deletion can take some time. Your device may require powering off and powering on for the changes to take effect.			
K-Config Example			
"#FACTORY", 0x0D			

12.3.1.4 HELP

Functions		Permission	Transparency
Set:	-	-	-
Get:	HELP	End User	Public
Description		Syntax	
Set:	-	-	
Get:	Get command list or help for specific command	1. #HELP <code>CR</code> 2. #HELP <code>SE</code> COMMAND_NAME <code>CR</code>	
Response			
1. Multi-line: ~nn@Device available protocol 3000 commands: <code>CR LF</code> command, <code>SE</code> command... <code>CR LF</code>			
2. Multi-line: ~nn@HELP <code>SE</code> command: <code>CR LF</code> description <code>CR LF</code> USAGE:usage <code>CR LF</code>			
Parameters			
COMMAND_NAME – name of a specific command			
Response Triggers			
Notes			
To get help for a specific command use: HELP <code>SE</code> COMMAND_NAME <code>CR LF</code>			
K-Config Example			
"#HELP", 0x0D			

12.3.1.5 MODEL

Functions		Permission	Transparency
Set:	-	-	-
Get:	MODEL?	End User	Public
Description		Syntax	
Set:	-	-	
Get:	Get device model	# MODEL? <code>[CR]</code>	
Response			
~ <code>[nn]</code> @ MODEL <code>[SP]</code> <i>model_name</i> <code>[CR LF]</code>			
Parameters			
<i>model_name</i> – String of up to 19 printable ASCII chars			
Response Triggers			
Notes			
This command identifies equipment connected to Step-in master products and notifies of identity changes to the connected equipment. The Matrix saves this data in memory to answer REMOTE-INFO requests			
K-Config Example			
"#MODEL?",0x0D			

12.3.1.6 PROT-VER

Functions		Permission	Transparency
Set:	-	-	-
Get:	PROT-VER?	End User	Public
Description		Syntax	
Set:	-	-	
Get:	Get device protocol version	# PROT-VER? <code>[CR]</code>	
Response			
~ <code>[nn]</code> @ PROT-VER <code>[SP]</code> 3000: <i>version</i> <code>[CR LF]</code>			
Parameters			
<i>version</i> - XX.XX where X is a decimal digit			
Response Triggers			
Notes			
K-Config Example			
"#PROT-VER?",0x0D			

12.3.1.7 RESET

Functions		Permission	Transparency
Set:	RESET	Administrator	Public
Get:	-	-	-
Description		Syntax	
Set:	Reset device	# RESET <input type="checkbox"/>	
Get:	-	-	
Response			
~ <input type="checkbox"/> <input type="checkbox"/> @ RESET <input type="checkbox"/> SE <input type="checkbox"/> OK <input type="checkbox"/> CR LF			
Parameters			
Response Triggers			
Notes			
To avoid locking the port due to a USB bug in Windows, disconnect USB connections immediately after running this command. If the port was locked, disconnect and reconnect the cable to reopen the port.			
K-Config Example			
"#RESET",0x0D			

12.3.1.8 SN

Functions		Permission	Transparency
Set:	-	-	-
Get:	SN?	End User	Public
Description		Syntax	
Set:	-	-	
Get:	Get device serial number	# SN? <input type="checkbox"/>	
Response			
~ <input type="checkbox"/> <input type="checkbox"/> @ SN <input type="checkbox"/> SE <input type="checkbox"/> <i>serial_number</i> <input type="checkbox">CR LF</input>			
Parameters			
<i>serial_number</i> – 11 decimal digits, factory assigned			
Response Triggers			
Notes			
This device has a 14 digit serial number, only the last 11 digits are displayed			
K-Config Example			
"#SN?",0x0D			

12.3.1.9 VERSION

Functions		Permission	Transparency
Set:	-	-	-
Get:	VERSION?	End User	Public
Description		Syntax	
Set:	-	-	
Get:	Get firmware version number	# VERSION? <code>CR</code>	
Response			
~ <code>nn</code> @ VERSION <code>SE</code> <i>firmware_version</i> <code>CR LF</code>			
Parameters			
<i>firmware_version</i> – XX.XX.XXXX where the digit groups are: major.minor.build version			
Response Triggers			
Notes			
K-Config Example			
`# VERSION? `,0x0D			

12.3.1.10 AV-SW-MODE

Functions		Permission	Transparency
Set:			
Get:	AV-SW-MODE?	End user	Public
Description		Syntax	
Set:			
Get:	Get input auto switch mode (per output)	# AV-SW-MODE? <code>SE</code> <i>layer,output_id</i> <code>CR</code>	
Response			
~ <code>nn</code> @ AV-SW-MODE <code>SE</code> <i>layer,output_id,mode</i> <code>CR LF</code>			
Parameters			
<i>layer</i> – 1 (video), 2 (audio) <i>output_id</i> – for video layer: 1 (HDMI Out), for audio layer: 1 (Audio Out) <i>mode</i> – 0 (manual), 1 (priority switch), 2 (last connected switch)			
Response Triggers			
Notes			
K-Config Example			
Get the input audio switch mode for HDMI Out: `# AV-SW-MODE? 1,1`,0x0D			

12.3.1.11 AV-SW-TIMEOUT

Functions		Permission	Transparency
Set:	AV-SW-TIMEOUT	End User	Public
Get:	AV-SW-TIMEOUT?	End User	Public
Description		Syntax	
Set:	Set auto switching timeout	# AV-SW-TIMEOUT <i>SP</i> <i>action,time_out</i> <i>CR</i>	
Get:	Get auto switching timeout	# AV-SW-TIMEOUT? <i>SP</i> <i>action</i> <i>CR</i>	
Response			
~ <i>nn</i> @ AV-SW-TIMEOUT <i>SP</i> <i>action,time_out</i> <i>CR</i>			
Parameters			
<p><i>action</i> – event that triggers the auto switching timeout:</p> <ul style="list-style-type: none"> 0 (video signal lost) 2 (audio signal lost) 4 (disable 5V on video output if no input signal detected) 5 (video cable unplugged) 6 (audio cable unplugged) <p><i>timeout</i> – timeout in seconds: 0-60000</p>			
Response Triggers			
Notes			
<p>The timeout must not exceed 60000 seconds.</p> <p>The timeout for video and audio signal lost (0, 2) events must not be less than 5 seconds.</p> <p>The timeout for video and audio cable unplugged (5, 6) events must not exceed the timeout for the disable 5V on video output if no input signal detected (4) event.</p> <p>The timeout for the disable 5V on video output if no input signal detected (4) event must not be less than the timeout for video and audio cable unplugged (5, 6) events.</p> <p>The timeout for the disable 5V on video output if no input signal detected (4) event overlaps with the timeouts for all other events (0, 2, 5, 6).</p> <p>This does not apply to VGA input.</p>			
K-Config Example			
<p>Set the auto switching timeout to 5 seconds in the event of video signal lost:</p> <pre>"#AV-SW-TIMEOUT 0,5",0x0D</pre>			

12.3.1.12 DISPLAY

Functions		Permission	Transparency
Set:	-	-	-
Get	DISPLAY?	End User	Public
Description		Syntax	
Set:	-	-	
Get:	Get output HPD status	# DISPLAY? <code>SP</code> <code>out_id</code> <code>CR</code>	
Response			
~ <code>nr</code> @ DISPLAY <code>SE</code> <code>out_id,status</code> <code>CR LF</code>			
Parameters			
<i>out_id</i> -1 (HDMI Out)			
<i>status</i> - HPD status according to signal validation : 0 (Off), 1 (On), 2 (On and all parameters are stable and valid)			
Response Triggers			
A response is sent to the com port from which the Get was received, after command execution and:			
After every change in output HPD status from On to Off (0)			
After every change in output HPD status from Off to On (1)			
After every change in output HPD status form Off to On and all parameters (new EDID, etc.) are stable and valid (2)			
Notes			
K-Config Example			
Get the output HPD status of HDMI Out: `#DISPLAY? 1",0xD`			

12.3.1.13 DPSW-STATUS

Functions		Permission	Transparency
Set:	-	-	-
Get:	DPSW-STATUS?	End User	Public
Description		Syntax	
Set:	-	-	
Get:	Get the DIP-switch status	# DPSW-STATUS? <input type="checkbox"/> <i>dp_sw_id</i> <input type="checkbox"/>	
Response			
~ <input type="checkbox"/> @ DPSW-STATUS? <input type="checkbox"/> <i>dp_sw_id,status</i> <input type="checkbox"/> <input type="checkbox"/>			
Parameters			
<i>dp_sw_id</i> - 1 (video switch), 2 (video switch), 3 (audio switch), 4 (audio switch) <i>status</i> - 0 (up / Off), 1 (down / On)			
Response Triggers			
Notes			
K-Config Example			
Get the status of DIP-switch 1 (video switch): `#DPSW-STATUS? 1",0x0D`			

12.3.1.14 FPGA-VER

Functions		Permission	Transparency
Set:	-	-	-
Get:	FPGA-VER?	End User	Public
Description		Syntax	
Set:	-	-	
Get:	Get current FPGA version	# FPGA-VER? <input type="checkbox"/> <i>id</i> <input type="checkbox"/>	
Response			
~ <input type="checkbox"/> @ FPGA-VER? <input type="checkbox"/> <i>id,major_ver,minor_ver</i> <input type="checkbox"/> <input type="checkbox"/>			
Parameters			
<i>id</i> - 1 (FPGA) <i>major_ver</i> - Major FPGA version number for current firmware <i>minor_ver</i> - Minor FPGA version number for current firmware			
Response Triggers			
Notes			
FPGA - field programmable gate array			
K-Config Example			
Get the FPGA version number for the current firmware: `#FPGA-VER? 1",0x0D`			

12.3.1.15 HDCP-MOD

Functions		Permission	Transparency
Set:	HDCP-MOD	Administrator	Public
Get:	HDCP-MOD?	End User	Public
Description		Syntax	
Set:	Set HDCP mode	# HDCP-MOD [SE] <i>inp_id</i> , <i>mode</i> [CR]	
Get:	Get HDCP mode	# HDCP-MOD? [SE] <i>inp_id</i> [CR]	
Response			
Set / Get: ~ <i>nn</i> @ HDCP-MOD [SE] <i>inp_id</i> , <i>mode</i> [CR LF]			
Parameters			
<i>inp_id</i> – input number: 1 (HDMI In 1), 2 (HDMI In 2), 3 (PC In) <i>mode</i> – HDCP mode: 0 (HDCP Off), 3 (Mirror output – MAC mode)			
Response Triggers			
A response is sent to the com port from which the set (before execution) / get command was received A response is sent to all com ports after command execution if HDCP-MOD was set by any other external control device (device button, device menu or other) or if the HDCP mode changed			
Notes			
Set HDCP working mode on the device input: HDCP not supported - HDCP Off HDCP support changes following detected sink - MIRROR OUTPUT			
K-Config Example			
Disable HDCP mode on HDMI In 2: `#HDCP-MOD 2,0",0x0D`			

12.3.1.16 HDCP-STAT

Functions		Permission	Transparency
Set:	-	-	-
Get:	HDCP-STAT?	End User	Public
Description		Syntax	
Set:	-	-	
Get:	Get HDCP signal status	#HDCP-STAT? <input type="text" value="stage,stage_id"/> <input type="text" value="CR"/>	
Response			
~ <input type="text" value="nr"/> @HDCP-STAT <input type="text" value="stage,stage_id,status"/> <input type="text" value="CR LF"/>			
Parameters			
<i>stage</i> – 0 (input), 1 (output) <i>stage_id</i> – for input stage: 1 (HDMI In 1), 2 (HDMI In 2), 3 (PC In), for output stage: 1 (HDMI Out) <i>status</i> – signal encryption status: 0 (On), 1 (Off)			
Response Triggers			
A response is sent to the com port from which the Get command was received			
Notes			
Output stage (1) – get the HDCP signal status of the sink device connected to HDMI Out Input stage (0) – get the HDCP signal status of the source device connected to the specified input			
K-Config Example			
Get the HDCP input signal status of the source device connected to HDMI In 1: `#HDCP-STAT? 0,1",0x0D			

12.3.1.17 NAME

Functions		Permission	Transparency
Set:	NAME	Administrator	Public
Get:	NAME?	End User	Public
Description		Syntax	
Set:	Set machine (DNS) name	# NAME [SP] <i>machine_name</i> [CR]	
Get:	Get machine (DNS) name	# NAME? [CR]	
Response			
Set:	~nn@ NAME [SP] <i>machine_name</i> [CR LF]		
Get:	~nn@ NAME? [SP] <i>machine_name</i> [CR LF]		
Parameters			
<i>machine_name</i> - String of up to 14 alpha-numeric characters (can include hyphens but not at the beginning or end)			
Response Triggers			
Notes			
The machine name is not the same as the model name. The machine name is used to identify a specific machine or a network in use (with DNS feature on).			
K-Config Example			
Set the DNS name of the device to "room-442": "#NAME room-442", 0x0D			

12.3.1.18 NAME-RST

Functions		Permission	Transparency
Set:	NAME-RST	Administrator	Public
Get:	-	-	-
Description		Syntax	
Set:	Reset machine (DNS) name to factory default	# NAME-RST [CR]	
Get:	-	-	
Response			
~nn@ NAME-RST [SP]OK[CR LF]			
Parameters			
Response Triggers			
Notes			
Factory default of machine (DNS) name is "KRAMER_"			
K-Config Example			
Reset the DNS name of the device to the factory default: "#NAME-RST", 0x0D			

12.3.1.19 PRIORITY

Functions		Permission	Transparency
Set:	PRIORITY	Administrator	Public
Get:	PRIORITY?	Administrator	Public
Description		Syntax	
Set:	Set input priority	# PRIORITY <u>SE</u> layer, <i>PRIORITY1</i> , <i>PRIORITY2</i> , <i>PRIORITY3</i> <u>CR</u>	
Get:	Get input priority	# PRIORITY? layer <u>CR</u>	
Response			
~ <u>na</u> @ PRIORITY <u>SE</u> layer, <i>PRIORITY1</i> , <i>PRIORITY2</i> , <i>PRIORITY3</i> <u>CR LE</u>			
Parameters			
layer – 1 (video): <i>PRIORITY1</i> - priority of HDMI In 1: 1 (highest priority), 2 (second priority), 3 (third priority) <i>PRIORITY2</i> - priority of HDMI In 2: 1 (highest priority), 2 (second priority), 3 (third priority) <i>PRIORITY3</i> - priority of PC In: 1 (highest priority), 2 (second priority), 3 (third priority) layer – 2 (audio): <i>PRIORITY1</i> - priority of embedded audio: 1 (highest priority), 2 (second priority) <i>PRIORITY2</i> - priority of Audio In: 1 (highest priority), 2 (second priority)			
Response Triggers			
Notes			
The number of PRIORITY parameters differs according to the selected layer 1 is the highest priority			
K-Config Example			
Set the video input priority of PC In as the highest priority: "#PRIORITY 1,2,3,1",0x0D			

12.3.1.20 SIGNAL

Functions		Permission	Transparency
Set:	-	-	-
Get	SIGNAL?	End User	Public
Description		Syntax	
Set:	-	-	
Get:	Get input signal lock status	# SIGNAL? <code>SP</code> <i>inp_id</i> <code>CR</code>	
Response			
~ <code>nn</code> @ SIGNAL <code>SP</code> <i>inp_id,status</i> <code>CR LF</code>			
Parameters			
<i>inp_id</i> – input number: 1 (HDMI In 1), 2 (HDMI In 2), 3 (PC In)			
<i>status</i> – lock status according to signal validation: 0 (Off), 1 (On)			
Response Triggers			
After execution, a response is sent to the com port from which the Get was received			
A response is sent after every change in input signal status from On to Off or from Off to On			
Notes			
K-Config Example			
Get the input signal lock status of HDMI In 2: `#SIGNAL? 2",0x0D`			

12.3.2 Authentication Commands

Command	Description
LOGIN	Set/get protocol permission
LOGOUT	Cancel current permission level
PASS	Set/get password for login level
SECUR	Set/get current security state

12.3.2.1 LOGIN

Functions		Permission	Transparency
Set:	LOGIN	Not Secure	Public
Get:	LOGIN?	Not Secure	Public
Description		Syntax	
Set:	Set protocol permission	#LOGIN ^[SP] login_level,password ^[CR]	
Get:	Get current protocol permission level	#LOGIN? ^[CR]	
Response			
Set: ~nn@LOGIN ^[SP] login_level,password ^[SP] OK ^[CR LF]			
or			
~nn@LOGIN ^[SP] ERR ^[SP] 004 ^[CR LF] (if bad password entered)			
Get: ~nn@LOGIN ^[SP] login_level ^[CR LF]			
Parameters			
<i>login_level</i> – level of permissions required: User, Admin			
<i>password</i> – predefined password (by PASS command). Default password is an empty string			
Response Triggers			
Notes			
When the permission system is enabled, LOGIN enables running commands with the User or Administrator permission level			
When set, login must be performed upon each connection			
The permission system works only if security is enabled with the SECUR command. It is not mandatory to enable the permission system in order to use the device			
K-Config Example			
Set the protocol permission level to Admin (when the password defined in the PASS command is 33333): "#LOGIN Admin,33333",0x0D			

12.3.2.2 LOGOUT

Functions		Permission	Transparency
Set:	LOGOUT	Not Secure	Public
Get:	-	-	-
Description		Syntax	
Set:	Cancel current permission level	# LOGOUT <input type="checkbox"/>	
Get:	-	-	
Response			
~ <input type="checkbox"/> @ LOGOUT <input type="checkbox"/> OK <input type="checkbox"/> CR LF			
Parameters			
Response Triggers			
Notes			
Logs out from User or Administrator permission levels			
K-Config Example			
"#LOGOUT",0x0D			

12.3.2.3 PASS

Functions		Permission	Transparency
Set:	PASS	Administrator	Public
Get:	PASS?	Administrator	Public
Description		Syntax	
Set:	Set password for login level	# PASS <input type="checkbox"/> login_level,password <input type="checkbox"/>	
Get:	Get password for login level	# PASS? <input type="checkbox"/> login_level <input type="checkbox"/>	
Response			
~ <input type="checkbox"/> @ PASS <input type="checkbox"/> login_level,password <input type="checkbox"/> CR LF			
Parameters			
login_level – level of login to set: User, Admin password – password for the login_level. Up to 15 printable ASCII chars.			
Response Triggers			
Notes			
The default password is an empty string			
K-Config Example			
Set the password for the Admin protocol permission level to 33333: "#PASS Admin,33333",0x0D			

12.3.2.4 SECUR

Functions		Permission	Transparency
Set:	SECUR	Administrator	Public
Get:	SECUR?	Not Secure	Public
Description		Syntax	
Set:	Start/stop security	# SECUR <input type="checkbox"/> <i>security_mode</i> <input type="checkbox"/>	
Get:	Get current security state	# SECUR? <input type="checkbox"/>	
Response			
~ <input type="checkbox"/> @ SECUR <input type="checkbox"/> <i>security_mode</i> <input type="checkbox"/> LF			
Parameters			
<i>security_mode</i> – 1 (On / enable security), 0 (Off / disable security)			
Response Triggers			
Notes			
The permission system works only if security is enabled with the SECUR command			
K-Config Example			
Enable the permission system: "#SECUR 0",0x0D			

12.3.3 Switching/Routing Commands

Command	Description
ROUTE	Set/get layer routing

12.3.3.1 ROUTE

Functions		Permission	Transparency
Set:	ROUTE	End User	Public
Get:	ROUTE?	End User	Public
Description		Syntax	
Set:	Set layer routing	#ROUTE SP layer, dest, src CR	
Get:	Get layer routing	#ROUTE? SP layer, dest CR	
Response			
~nn@ROUTE SP layer, dest, src CR LF			
Parameters			
layer - 1 (video) dest - 1 (HDMI Out) src - 1 (HDMI In 1), 2 (HDMI In 2), 3 (PC In)			
Response Triggers			
Notes			
The get command identifies input switching on Step-in clients The set command is for remote input switching on Step-in clients (essentially via by the Web)			
K-Config Example			
Set the remote input switching of video to HDMI Out from HDMI In 2: `#ROUTE 1,1,2",0x0D`			

12.3.4 Video Commands

Command	Description
VGA-PHASE	Set/get ADC (VGA) sampling phase
VMUTE	Set/get video on output mute

12.3.4.1 VGA-PHASE

Functions		Permission	Transparency
Set:	VGA-PHASE	End User	Public
Get:	VGA-PHASE?	End User	Public
Description		Syntax	
Set:	Set ADC (VGA) sampling phase	# VGA-PHASE <u>SP</u> <i>channel,value</i> <u>CR</u>	
Get:	Get ADC (VGA) sampling phase	# VGA-PHASE? <u>SP</u> <i>channel</i> <u>CR</u>	
Response			
~ <u>nn</u> @ VGA-PHASE <u>SP</u> <i>channel,value</i> <u>CR LF</u>			
Parameters			
<i>channel</i> – input number: 3 (PC In)			
<i>value</i> – phase number in LSB units: 1-30, ++ (increase current value), -- (decrease current value)			
Response Triggers			
Notes			
K-Config Example			
Increase the current value of the ADC (VGA) sampling phase: `#VGA-PHASE 3,++,0x0D`			

12.3.4.2 VMUTE

Functions		Permission	Transparency
Set:	VMUTE	End User	Public
Get:	VMUTE?	End User	Public
Description		Syntax	
Set:	Set enable/disable video on output	# VMUTE [SP output_id,flag CR]	
Get:	Get video on output status	# VMUTE? [SP output_id SP CR]	
Response			
Set / Get: ~[nn @ VMUTE [SP output_id,flag CR LF]			
Parameters			
output_id - 1 (HDMI Out) flag - 0 (disable video on output), 1 (enable video on output), 2 (blank video)			
Response Triggers			
Notes			
K-Config Example			
Disable the video output on HDMI Out: "#VMUTE 3,0",0x0D			

12.3.5 Audio Commands

Command	Description
AUD-EMB	Get audio in video embedding status
AUD-LVL	Set/get volume for specific amplifier output
AUD-SIGNAL?	Get audio input signal status
MUTE	Set/get audio mute

12.3.5.1 AUD-EMB

Functions	Permission	Transparency
Set:		
Get:	AUD-EMB?	End User Public
Description	Syntax	
Set:		
Get:	Get audio in video embedding status	#AUD-EMB? <i>SF</i> <i>in,out</i> <i>CR</i>
Response		
~ <i>nn</i> @AUD-EMB <i>SF</i> <i>in,out,status</i> <i>CR LF</i>		
Parameters		
<i>in</i> – embedded audio input number: 1 (Audio In) <i>out</i> – video output number in which audio is embedded: 1 (HDMI Out) <i>status</i> – embedded status: 1 (On), 0 (Off)		
Response Triggers		
A response is sent to the com port from which the get command was received After execution, a response is sent to all com ports if AUD-EMB was set by any other external control device (button press, device menu and similar)		
Notes		
K-Config Example		
`#AUD-EMB? 1,1",0x0D`		

12.3.5.2 AUD-LVL

Functions		Permission	Transparency
Set:	AUD-LVL	End User	Public
Get:	AUD-LVL?	End User	Public
Description		Syntax	
Set:	Set volume for specific amplifier output	#AUD-LVL <input type="text" value="stage,channel,volume"/> <input type="text" value="CR"/>	
Get:	Get volume for specific amplifier output	#AUD-LVL? <input type="text" value="stage,channel"/> <input type="text" value="CR"/>	
Response			
~ <input type="text" value="nn"/> @AUD-LVL <input type="text" value="stage,channel,volume"/> <input type="text" value="CR LF"/>			
Parameters			
<i>stage</i> – 1 (audio output) <i>channel</i> – output channel number of selected stage: 1 (Audio Out) <i>volume</i> – audio parameter percentage: 0-100 (percent value), ++ (increase current value by 1 percent), -- decrease current value by 1 percent			
Response Triggers			
Notes			
All values are in percentages A minus sign precedes negative values			
K-Config Example			
Set the volume of the Audio Out (1) output to 75%: "#AUD-LVL 1,1,75",0x0D			

12.3.5.3 AUD-SIGNAL

Functions		Permission	Transparency
Set:	-	-	-
Get	AUD-SIGNAL?	End User	Public
Description		Syntax	
Set:	-	-	
Get:	Get audio input signal status	# AUD-SIGNAL? <code>[SF]</code> <i>inp_id</i> <code>[CR]</code>	
Response			
~ <code>[nn]</code> @ AUD-SIGNAL <code>[SF]</code> <i>inp_id,status</i> <code>[CR LF]</code>			
Parameters			
<i>inp_id</i> – audio input number: 1 (Audio In) <i>status</i> – 0 (Off / no signal), 1 (On / signal present)			
Response Triggers			
After execution, a response is sent to the com port from which the get command was received A response is sent to all com ports if the audio status was changed on any input			
Notes			
K-Config Example			
`#AUD-SIGNAL? 1",0x0D			

12.3.5.4 MUTE

Functions		Permission	Transparency
Set:	MUTE	End User	Public
Get:	MUTE?	End User	Public
Description		Syntax	
Set:	Set audio mute	# MUTE <code>[SF]</code> <i>channel,mute_mode</i> <code>[CR]</code>	
Get:	Get audio mute	# MUTE? <code>[SF]</code> <i>channel</i> <code>[CR]</code>	
Response			
~ <code>[nn]</code> @ MUTE <code>[SF]</code> <i>channel, mute_mode</i> <code>[CR LF]</code>			
Parameters			
<i>channel</i> – audio output number: 1 (Audio Out) <i>mute_mode</i> – 0 (Off), 1 (On)			
Response Triggers			
Notes			
K-Config Example			
Mute the Audio Out output: `#MUTE 1,1",0x0D			

12.3.6 Communication Commands

Command	Description
ETH-PORT	Set/get Ethernet port protocol
NET-DHCP	Set/get DHCP mode
NET-GATE	Set/get gateway IP
NET-IP	Set/get IP address
NET-MAC	Get MAC address
NET-MASK	Set/get subnet mask

12.3.6.1 ETH-PORT

Functions		Permission	Transparency
Set:	ETH-PORT	Administrator	Public
Get:	ETH-PORT?	End User	Public
Description		Syntax	
Set:	Set Ethernet port protocol	# ETH-PORT S P <i>portType</i> , <i>ETHPort</i> C R	
Get:	Get Ethernet port protocol	# ETH-PORT? S P <i>portType</i> C R	
Response			
~ nn @ ETH-PORT S P <i>portType</i> , <i>ETHPort</i> C R L F			
Parameters			
<i>portType</i> – string of 3 letters indicating the port type: TCP, UDP			
<i>ETHPort</i> – TCP / UDP port number: 0-65565			
Response Triggers			
Notes			
If the port number you enter is already in use, an error is returned			
The port number must be within the following range: 0-(2 ¹⁶ -1)			
K-Config Example			
Set the Ethernet port protocol for TCP to port 12457: "#ETH-PORT TCP,12457",0x0D			

12.3.6.2 NET-DHCP

Functions		Permission	Transparency
Set:	NET-DHCP	Administrator	Public
Get:	NET-DHCP?	End User	Public
Description		Syntax	
Set:	Set DHCP mode	#NET-DHCP <i>SE</i> <i>mode</i> <i>CR</i>	
Get:	Get DHCP mode	#NET-DHCP? <i>CR</i>	
Response			
~ <i>nn</i> @NET-DHCP <i>SE</i> <i>mode</i> <i>CR</i> LF			
Parameters			
<i>mode</i> – 0 (do not use DHCP. Use the IP address set by the factory or the NET-IP command), 1 (try to use DHCP. If unavailable, use the IP address set by the factory or the NET-IP command)			
Response Triggers			
Notes			
<p>Connecting Ethernet to devices with DHCP may take more time in some networks</p> <p>To connect with a randomly assigned IP by DHCP, specify the device DNS name (if available) using the NAME command. You can also get an assigned IP by direct connection to USB or RS-232 protocol port if available</p> <p>Consult your network administrator for correct settings</p>			
K-Config Example			
<p>Enable DHCP mode, if available:</p> <pre>"#NET-DHCP 1",0x0D</pre>			

12.3.6.3 NET-GATE

Functions		Permission	Transparency
Set:	NET-GATE	Administrator	Public
Get:	NET-GATE?	End User	Public
Description		Syntax	
Set:	Set gateway IP	# NET-GATE SP <i>ip_address</i> CR	
Get:	Get gateway IP	# NET-GATE? CR	
Response			
~ nn @ NET-GATE SP <i>ip_address</i> CR LF			
Parameters			
<i>ip_address</i> – gateway IP address, in the following format: xxx.xxx.xxx.xxx			
Response Triggers			
Notes			
A network gateway connects the device via another network, possibly over the Internet. Be careful of security problems. Consult your network administrator for correct settings.			
K-Config Example			
Set the gateway IP address to 192.168.0.1: "#NET-GATE 192.168.000.001",0x0D			

12.3.6.4 NET-IP

Functions		Permission	Transparency
Set:	NET-IP	Administrator	Public
Get:	NET-IP?	End User	Public
Description		Syntax	
Set:	Set IP address	# NET-IP SP <i>ip_address</i> CR	
Get:	Get IP address	# NET-IP? CR	
Response			
~ nn @ NET-IP SP <i>ip_address</i> CR LF			
Parameters			
<i>ip_address</i> – IP address, in the following format: xxx.xxx.xxx.xxx			
Response Triggers			
Notes			
Consult your network administrator for correct settings			
K-Config Example			
Set the IP address to 192.168.1.39: "#NET-IP 192.168.001.039",0x0D			

12.3.6.5 NET-MAC

Functions		Permission	Transparency
Set:	-	-	-
Get:	NET-MAC?	End User	Public
Description		Syntax	
Set:	-	-	
Get:	Get MAC address	#NET-MAC?	CR
Response			
~nn@NET-MAC\$Pmac_addressCR LF			
Parameters			
mac_address - unique MAC address. Format: XX-XX-XX-XX-XX-XX where X is hex digit			
Response Triggers			
Notes			
K-Config Example			
"#NET-MAC?", 0x0D			

12.3.6.6 NET-MASK

Functions		Permission	Transparency
Set:	NET-MASK	Administrator	Public
Get:	NET-MASK?	End User	Public
Description		Syntax	
Set:	Set subnet mask	#NET-MASK\$Pnet_maskCR	
Get:	Get subnet mask	#NET-MASK?	CR
Response			
~nn@NET-MASK\$Pnet_maskCR LF			
Parameters			
net_mask - format: xxx.xxx.xxx.xxx			
Response Triggers			
The subnet mask limits the Ethernet connection within the local network Consult your network administrator for correct settings			
Notes			
K-Config Example			
Set the subnet mask to 255.255.0.0: "#NET-MASK 255.255.000.000", 0x0D			

12.3.7 EDID Handling Commands

Additional EDID data functions can be performed via the **DIP-31** web pages or a compatible EDID management application, such as Kramer EDID Designer (see <http://www.kramerav.com/product/EDID%20Designer>).

Command	Description
CPEDID	Copy EDID data from the output to the input EEPROM
LOCK-EDID	Lock last read EDID

12.3.7.1 CPEDID

Functions		Permission	Transparency
Set:	CPEDID	End User	Public
Get:	-	-	-
Description		Syntax	
Set:	Copy EDID data from the output to the input EEPROM	#CPEDID[SE]src_type,src_id,dst_type,dest_bitmap[CR LF]	
Get:	-	-	
Response			
~nn@CPEDID[SE]src_type,src_id,dst_type,dest_bitmap[CR LF]			
Parameters			
<p>src_type – EDID source type (usually output): 0 (input), 1 (output), 2 (default EDID)</p> <p>src_id – for input source: 1 (HDMI In 1), 2 (HDMI In 2), 3 (PC In), for output source: 1 (HDMI Out), for default EDID source: 0 (default EDID)</p> <p>dst_type – EDID destination type (usually input): 0 (input), 1 (output), 2 (default EDID)</p> <p>dest_bitmap – bitmap representing destination IDs. Format: XXXX...X, where X is hex digit. The binary form of every hex digit represents corresponding destinations. Setting '1' indicates that EDID data is copied to this destination. Setting '0' indicates that EDID data is not copied to this destination.</p>			
Response Triggers			
Response is sent to the com port from which the Set was received (before execution)			
Notes			
<p>Destination bitmap size depends on device properties (for 64 inputs it is a 64-bit word)</p> <p>Example: bitmap 0x0013 means inputs 1, 2 and 5 are loaded with the new EDID.</p> <p>In this device, if the destination type is input (0), the bitmap size is 3 bits, for example bitmap 0x5 means inputs 1 and 3 are loaded with the new EDID.</p>			
K-Config Example			
<p>Copy the EDID data from the HDMI Out output (EDID source) to the HDMI In 1 input:</p> <pre>"#CPEDID 1,1,0,0x1",0x0D</pre> <p>Copy the EDID data from the default EDID source to HDMI In 1 and PC In inputs:</p> <pre>"#CPEDID 2,0,0,0x5",0x0D</pre>			

12.3.7.2 LOCK-EDID

Functions		Permission	Transparency
Set:	LOCK-EDID	End User	End User
Get:	LOCK-EDID?	End User	End User
Description		Syntax	
Set:	Lock last read EDID	#LOCK-EDID <code>[SP]input_id,lock_mode[CR]</code>	
Get:	Get EDID lock state	#LOCK-EDID? <code>[SP]input_id[CR]</code>	
Response			
~ <code>[nn]@LOCK-EDID [SP]input_id,lock_mode[CR LF]</code>			
Parameters			
<i>input_id</i> - 1 (HDMI In 1), 2 (HDMI In 2), 3 (PC In), <i>lock_mode</i> - 0 (Off: unlocks EDID), 1 (On: locks EDID)			
Response Triggers			
Notes			
K-Config Example			
Lock the last read EDID from the HDMI In 2 input: "#LOCK-EDID 2,1",0x0D			

LIMITED WARRANTY

The warranty obligations of Kramer Electronics for this product are limited to the terms set forth below:

What is Covered

This limited warranty covers defects in materials and workmanship in this product.

What is Not Covered

This limited warranty does not cover any damage, deterioration or malfunction resulting from any alteration, modification, improper or unreasonable use or maintenance, misuse, abuse, accident, neglect, exposure to excess moisture, fire, improper packing and shipping (such claims must be presented to the carrier), lightning, power surges, or other acts of nature. This limited warranty does not cover any damage, deterioration or malfunction resulting from the installation or removal of this product from any installation, any unauthorized tampering with this product, any repairs attempted by anyone unauthorized by Kramer Electronics to make such repairs, or any other cause which does not relate directly to a defect in materials and/or workmanship of this product. This limited warranty does not cover cartons, equipment enclosures, cables or accessories used in conjunction with this product.

Without limiting any other exclusion herein, Kramer Electronics does not warrant that the product covered hereby, including, without limitation, the technology and/or integrated circuit(s) included in the product, will not become obsolete or that such items are or will remain compatible with any other product or technology with which the product may be used.

How Long Does this Coverage Last

Seven years as of this printing; please check our Web site for the most current and accurate warranty information.

Who is Covered

Only the original purchaser of this product is covered under this limited warranty. This limited warranty is not transferable to subsequent purchasers or owners of this product.

What Kramer Electronics will do

Kramer Electronics will, at its sole option, provide one of the following three remedies to whatever extent it shall deem necessary to satisfy a proper claim under this limited warranty:

1. Elect to repair or facilitate the repair of any defective parts within a reasonable period of time, free of any charge for the necessary parts and labor to complete the repair and restore this product to its proper operating condition. Kramer Electronics will also pay the shipping costs necessary to return this product once the repair is complete.
2. Replace this product with a direct replacement or with a similar product deemed by Kramer Electronics to perform substantially the same function as the original product.
3. Issue a refund of the original purchase price less depreciation to be determined based on the age of the product at the time remedy is sought under this limited warranty.

What Kramer Electronics will not do Under This Limited Warranty

If this product is returned to Kramer Electronics or the authorized dealer from which it was purchased or any other party authorized to repair Kramer Electronics products, this product must be insured during shipment, with the insurance and shipping charges prepaid by you. If this product is returned uninsured, you assume all risks of loss or damage during shipment. Kramer Electronics will not be responsible for any costs related to the removal or re-installation of this product from or into any installation. Kramer Electronics will not be responsible for any costs related to any setting up this product, any adjustment of user controls or any programming required for a specific installation of this product.

How to Obtain a Remedy under this Limited Warranty

To obtain a remedy under this limited warranty, you must contact either the authorized Kramer Electronics reseller from whom you purchased this product or the Kramer Electronics office nearest you. For a list of authorized Kramer Electronics resellers and/or Kramer Electronics authorized service providers, please visit our web site at www.kramerelectronics.com or contact the Kramer Electronics office nearest you.

In order to pursue any remedy under this limited warranty, you must possess an original, dated receipt as proof of purchase from an authorized Kramer Electronics reseller. If this product is returned under this limited warranty, a return authorization number, obtained from Kramer Electronics, will be required. You may also be directed to an authorized reseller or a person authorized by Kramer Electronics to repair the product.

If it is decided that this product should be returned directly to Kramer Electronics, this product should be properly packed, preferably in the original carton, for shipping. Cartons not bearing a return authorization number will be refused.

Limitation on Liability

THE MAXIMUM LIABILITY OF KRAMER ELECTRONICS UNDER THIS LIMITED WARRANTY SHALL NOT EXCEED THE ACTUAL PURCHASE PRICE PAID FOR THE PRODUCT. TO THE MAXIMUM EXTENT PERMITTED BY LAW, KRAMER ELECTRONICS IS NOT RESPONSIBLE FOR DIRECT, SPECIAL, INCIDENTAL OR CONSEQUENTIAL DAMAGES RESULTING FROM ANY BREACH OF WARRANTY OR CONDITION, OR UNDER ANY OTHER LEGAL THEORY. Some countries, districts or states do not allow the exclusion or limitation of relief, special, incidental, consequential or indirect damages, or the limitation of liability to specified amounts, so the above limitations or exclusions may not apply to you.

Exclusive Remedy

TO THE MAXIMUM EXTENT PERMITTED BY LAW, THIS LIMITED WARRANTY AND THE REMEDIES SET FORTH ABOVE ARE EXCLUSIVE AND IN LIEU OF ALL OTHER WARRANTIES, REMEDIES AND CONDITIONS, WHETHER ORAL OR WRITTEN, EXPRESS OR IMPLIED. TO THE MAXIMUM EXTENT PERMITTED BY LAW, KRAMER ELECTRONICS SPECIFICALLY DISCLAIMS ANY AND ALL IMPLIED WARRANTIES, INCLUDING, WITHOUT LIMITATION, WARRANTIES OF MERCHANTABILITY AND FITNESS FOR A PARTICULAR PURPOSE. IF KRAMER ELECTRONICS CANNOT LAWFULLY DISCLAIM OR EXCLUDE IMPLIED WARRANTIES UNDER APPLICABLE LAW, THEN ALL IMPLIED WARRANTIES COVERING THIS PRODUCT, INCLUDING WARRANTIES OF MERCHANTABILITY AND FITNESS FOR A PARTICULAR PURPOSE, SHALL APPLY TO THIS PRODUCT AS PROVIDED UNDER APPLICABLE LAW.

IF ANY PRODUCT TO WHICH THIS LIMITED WARRANTY APPLIES IS A "CONSUMER PRODUCT" UNDER THE MAGNUSON-MOSS WARRANTY ACT (15 U.S.C.A. §2301, ET SEQ.) OR OTHER APPLICABLE LAW, THE FOREGOING DISCLAIMER OF IMPLIED WARRANTIES SHALL NOT APPLY TO YOU, AND ALL IMPLIED WARRANTIES ON THIS PRODUCT, INCLUDING WARRANTIES OF MERCHANTABILITY AND FITNESS FOR THE PARTICULAR PURPOSE, SHALL APPLY AS PROVIDED UNDER APPLICABLE LAW.

Other Conditions

This limited warranty gives you specific legal rights, and you may have other rights which vary from country to country or state to state.

This limited warranty is void if (i) the label bearing the serial number of this product has been removed or defaced, (ii) the product is not distributed by Kramer Electronics or (iii) this product is not purchased from an authorized Kramer Electronics reseller. If you are unsure whether a reseller is an authorized Kramer Electronics reseller, please visit our Web site at www.kramerelectronics.com or contact a Kramer Electronics office from the list at the end of this document.

Your rights under this limited warranty are not diminished if you do not complete and return the product registration form or complete and submit the online product registration form. Kramer Electronics thanks you for purchasing a Kramer Electronics product. We hope it will give you years of satisfaction.

KRAMER



P/N: 2900-300630



Rev: 2



SAFETY WARNING

Disconnect the unit from the power supply before opening and servicing

For the latest information on our products and a list of Kramer distributors, visit our Web site where updates to this user manual may be found.

We welcome your questions, comments, and feedback.

www.kramerAV.com
info@kramerel.com