



USER MANUAL

MODEL:

KT-205WM

5.5" Touch Panel

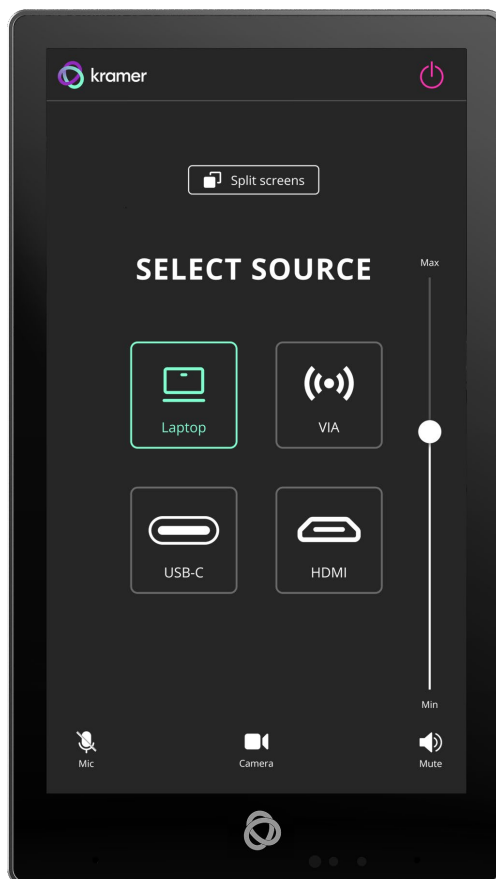

Contents

Contents	2
Introduction	3
Getting Started	3
Overview	4
Defining KT-205WM 5.5" Touch Panel	5
On-Wall Mount	6
Mounting the KT-205WM	7
Mounting KT-205WM on a Wall	7
Connection Options	8
Controlling KT-205WM	9
Using Navigation Buttons or Gestures	9
Using the Home Page	10
Exiting or Starting the Kramer Control app	10
Basic Settings of KT-205WM	11
Essential First Steps	11
Setting the Date and Time	11
Connecting to Wi-Fi or Ethernet	12
Installing an 802.1X Certificate	13
Changing the Automated Firmware Update	14
Changing the Automated Kramer Control Agent Update	16
Setting the Display and Keyboard Language	17
Using the Kramer Control agent (connecting to Brain)	18
Updating the interface URL in the Kramer Control agent	19
Advanced Settings	23
Factory Reset & Reboot	23
Logging Activity	24
Technical Specifications	25

Introduction

Welcome to Kramer Electronics! Since 1981, Kramer Electronics has been providing a world of unique, creative, and affordable solutions to the vast range of problems that confront the video, audio, presentation, and broadcasting professional on a daily basis. In recent years, we have redesigned and upgraded most of our line, making the best even better!

Getting Started

We recommend that you:

- Unpack the equipment carefully and save the original box and packaging materials for possible future shipment.
- Review the contents of this user manual.



Go to www.kramerav.com/downloads/KT-205WM to check for up-to-date user manuals, application programs, and to check if firmware upgrades are available (where appropriate).

Achieving Best Performance

- Use only good quality connection cables (we recommend Kramer high-performance, high-resolution cables) to avoid interference, deterioration in signal quality due to poor matching, and elevated noise levels (often associated with low quality cables).
- Do not secure the cables in tight bundles or roll the slack into tight coils.
- Avoid interference from neighboring electrical appliances that may adversely influence signal quality.
- Position your Kramer **KT-205WM** away from moisture, excessive sunlight and dust.

Safety Instructions



Caution:

- This equipment is to be used only inside a building. It may only be connected to other equipment that is installed inside a building.
- For products with relay terminals and GPIO ports, please refer to the permitted rating for an external connection, located next to the terminal or in the User Manual.
- There are no operator serviceable parts inside the unit.



Warning:

- If not using PoE, use only the optional power cord that is supplied for the unit.
- Do not open the unit. High voltages can cause electrical shock! Servicing by qualified personnel only.

Recycling Kramer Products

The Waste Electrical and Electronic Equipment (WEEE) Directive 2002/96/EC aims to reduce the amount of WEEE sent for disposal to landfill or incineration by requiring it to be collected and recycled. To comply with the WEEE Directive, Kramer Electronics has made arrangements with

the European Advanced Recycling Network (EARN) and will cover any costs of treatment, recycling and recovery of waste Kramer Electronics branded equipment on arrival at the EARN facility. For details of Kramer's recycling arrangements in your particular country go to our recycling pages at www.kramerav.com/social-responsibility/environment.

Overview

Congratulations on purchasing your **Kramer KT-205WM 5.5" Touch Panel**.

KT-205WM is a new powerful, 5.5 inch, IPS, multi-touch, touch panel with 720x1280 resolution. Elegantly designed for wall-mounted decorative room integration.

KT-205WM runs the latest Android 11, supports wired PoE (Power over Ethernet) and advanced Wi-Fi connectivity options. The touch panel has a built-in speaker and camera and comes with a wall mount. The touch panel is easy to assemble, with elegant wiring and secured mounting providing reliable operation and flexible deployment.

KT-205WM touch panel is ideal for any 24/7 Kramer-supported commercial AV or control applications and features a user-friendly, fully customizable graphical user interface configured by Kramer software.

Exceptional Quality

- Superior User Experience – IPS 720x1280 hi-resolution screen with $\pm 80^\circ$ horizontal and vertical wide viewing angles, ambient light sensor and proximity sensor with advanced 10 multi-touch points and 2-finger gesture capabilities.
- Powerful Processing – i.MX8M Plus Quad Core A53, 2GB RAM, 32GB ROM processing performance, smoothly running complicated media and graphics-rich applications, such as H.265 video and audio stream encoding and decoding.
- Flexible Services – Latest Android 11 operating system.

Advanced and User-friendly Operation

- Easy Installation – Powering and connectivity via a single Ethernet cable.
- Optional Connectivity – Wireless Bluetooth 5 and connection to USB peripheral devices.
- Reliable Networking – Seamless switching between wired and wireless 802.11ac connectivity.
- Versatile Powering Options – PoE or power adapter (sold separately).
- Auto Sensing – Optimized performance and operation according to automatically detected LAN speed.
- Firmware Upgrade – Define automatic updates at a predefined time of day or update manually using the USB port.

Typical Applications

KT-205WM is ideal for controlling user interfaces in meeting and conference rooms, boardrooms, and auditoriums.

Defining KT-205WM 5.5" Touch Panel

This section defines KT-205WM.

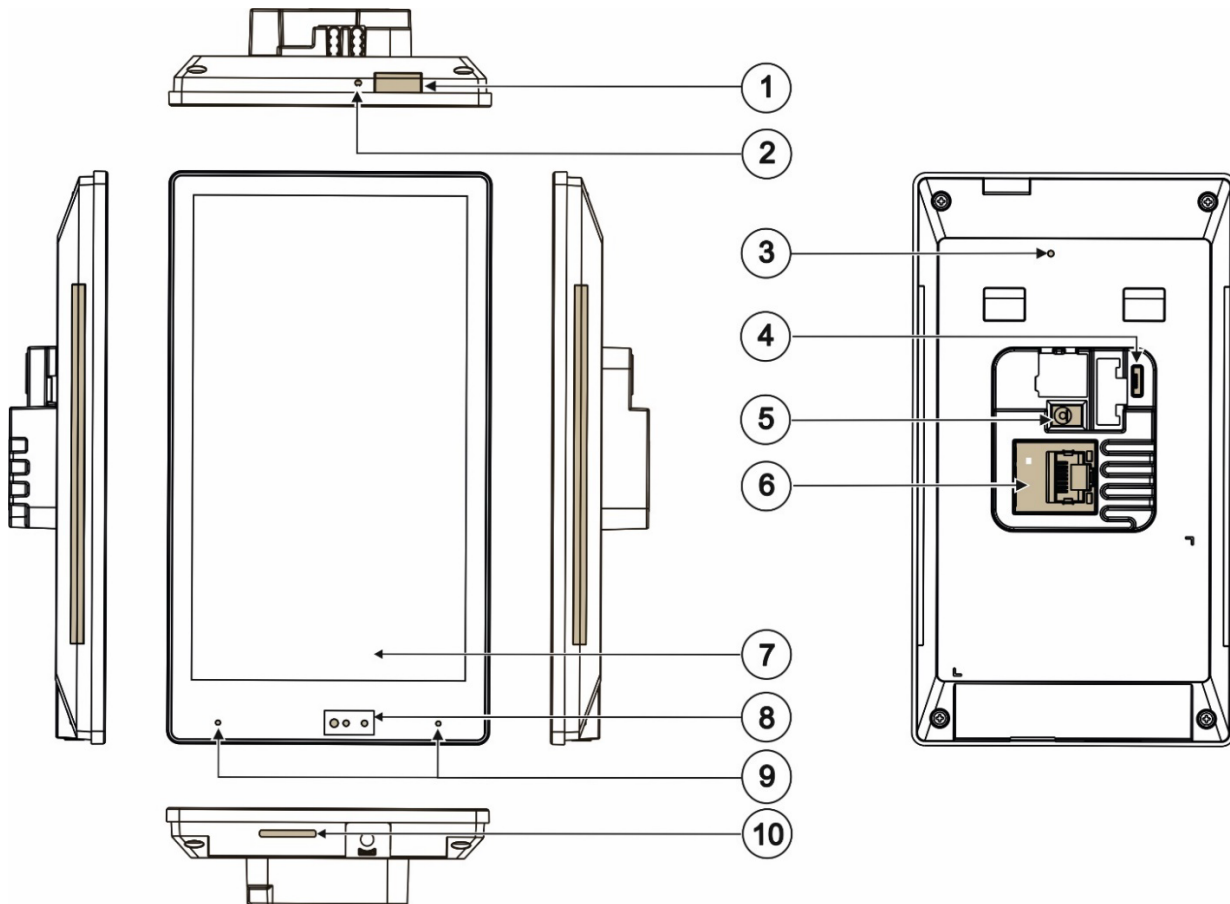

Figure 1: KT-205WM 5.5" Touch Panel

#	Feature	Function
①	Home Button	Press to wake up / darken the screen.
②	Recessed Restart Button	Located on the top-side. Insert a pin and hold for a few seconds to restart.
③	Restore Factory Reset Button	Insert a pin and hold for 22 seconds to reset the device to factory default values.
④	Micro USB Port	For connecting to an adjacent on-wall USB device and for firmware upgrade.
⑤	12V/1A DC Connector	Connect to the power adapter (optional, purchased separately).
⑥	LAN 1G(PoE) RJ-45 Port	Connect to the LAN for network communication. KT-205WM is powered by PoE (power over ethernet) delivered through the LAN port. Optionally, you can connect the power adapter too (as backup).
⑦	Display	Touch panel.
⑧	Light Sensor	Automatically adjusts the screen brightness according to the room lighting conditions.
⑨	Microphone	For audio communication, recording or conferencing.
⑩	Speaker	To output the sound.

On-Wall Mount

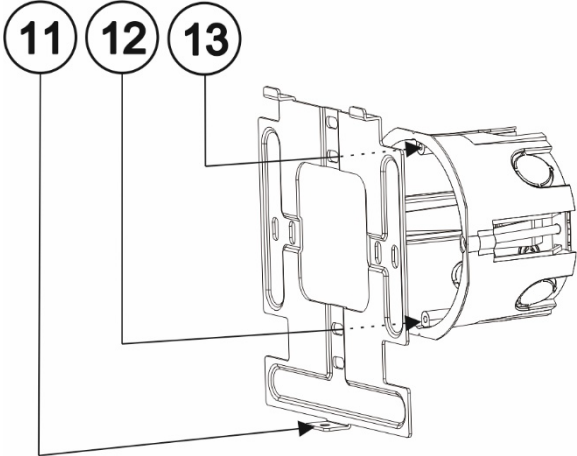



Figure 2: On Wall Mount

#	Feature	Function
11	Screw Opening	For securing the 5.5" Touch Panel to the wall mount bracket using the supplied M2.5 screw.
12	M3.2 Screw Opening	For securing the wall mount bracket to the gang box.
13	M3.2 Screw Opening	For securing the wall mount bracket to the gang box.

Mounting the KT-205WM

 Always be careful when attaching or removing the 5.5" Touch Panel from a mount.

Mounting KT-205WM on a Wall

To mount the device on a wall:

 **KT-205WM can only be mounted in portrait mode.**

1. Install an in-wall gang box.
2. Attach the wall mount bracket to the installed gang box (top side up: see the indication arrows on the bracket), using two M3.2 screws provided.
The wall mount bracket works with UK, EU and US single gang boxes. Screws are provided for all configurations.
3. Connect Ethernet and/or power cables and optionally, insert the micro-USB cable (supplied) for connecting to an adjacent external USB device.

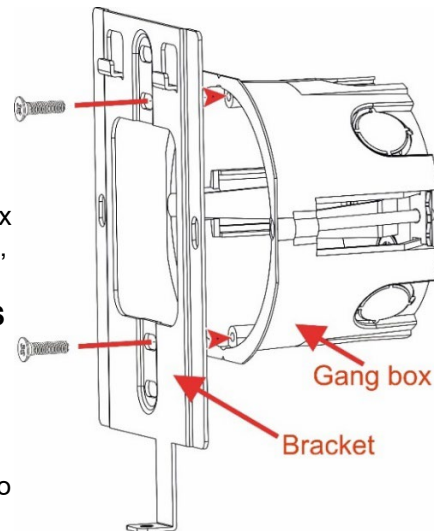

4. Rest **KT-205WM** on the wall mount bracket:
 - a) Line up the top holders and the bottom mounting screw hole.
 - b) Push the touch panel down, snapping the top holders into place.

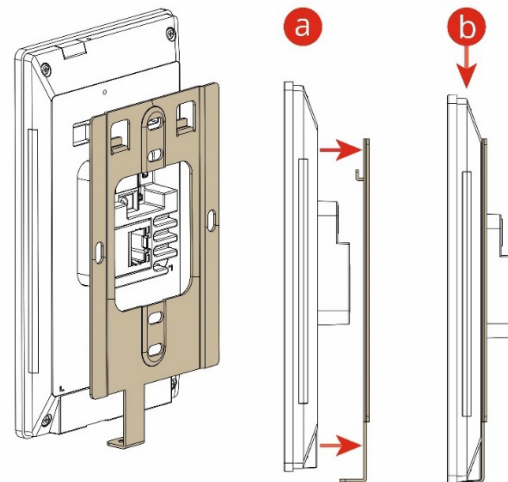

5. Insert one M2.5 screw below the touch panel and secure the touch panel to the wall mount bracket.

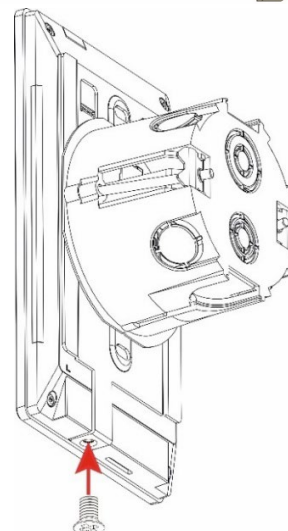

Connection Options

Connect KT-205 to power using one or both of the following options:

1. Connect the PoE-enabled LAN RJ-45 connector to your local area PoE-enabled network.
2. Connect the power adapter to the 12V DC connector on the rear side. The power adapter is optional: It can be purchased separately.

 When both PoE and the power supply are connected to the touch panel, the unit is powered by the power supply.

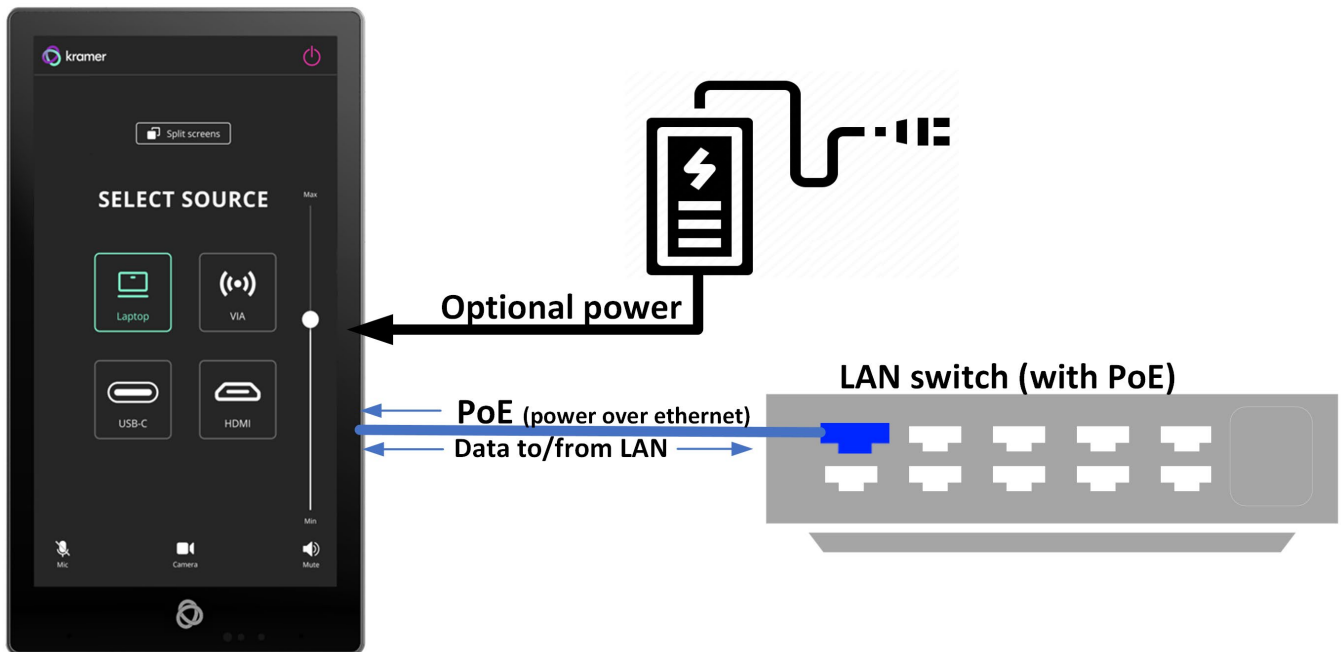

Figure 3: Powering the Touch Panel

Controlling KT-205WM

Using Navigation Buttons or Gestures

By default, **KT-205WM** runs the Kramer Control agent and displays its login screen at start-up. You can also use navigation buttons displayed at the bottom of the screen or setup your device to use gesture-based navigation.

Using navigation buttons

Swipe a finger upwards from the line at the bottom of the screen and release to see the navigation buttons:

- ◀ - **Back** – Returns to the previous screen (or opens the home page if there is none).
- - **Home** – Opens the home page, see [Using the Home Page](#) on page [10](#).
- - **Recent apps** – Scroll between the active apps.

Changing the navigation system

By default, navigation buttons are used, however the touch panel can be set to use gesture navigation instead.

To change the navigation method:

1. If the touch panel is running the Kramer Control agent, exit the Kramer Control agent by entering the PIN (default 9428). If the PIN button is not displayed, swipe up from the Kramer icon at the bottom of the screen to bring up the PIN entry pop-up.
2. On the Home page, press **Settings** . The device's **Settings** menu opens.
3. Select **Advanced settings > System**.
4. In the System menu, press **Gestures** and then **System navigation**.
5. Select **Gesture navigation** or **3-button navigation**. If you are using Gesture navigation, the sensitivity is adjustable.

Using Gesture navigation

- **Back** – Drag a finger inwards from the left or right edge of the screen.
- **Home** – Swipe a finger upwards from the line at the bottom of the screen and release.
- **Recent apps** – Swipe a finger upwards from the line at the bottom of the screen and hold.

Hiding the Navigation Bar

To hide/unhide the navigation bar:

1. On the Home page, press the **Settings** button . The device's **Settings** menu opens.
2. In the Settings menu, open **Player settings** and enable **Fullscreen mode**.

Using the Home Page

Swipe a finger upwards from the line at the bottom of the screen and release to see the navigation buttons:

- - **Home** – Opens the home page.

The Home page contains the following icons:



- Chromium browser



- Touch panel settings



- Kramer Control Agent

Exiting or Starting the Kramer Control app

KT-205WM comes with a **Kramer Control agent** (icon ) pre-installed app. The role of this app is to display an interface that you defined in Kramer Control.

When the touch panel starts, the Kramer Control agent runs automatically. To exit the Kramer Control agent, enter the PIN (default 9428). If the PIN button is not displayed, swipe up from the Kramer icon at the bottom of the screen to bring up the PIN entry pop-up.

To re-open the Control Agent click the  icon on the Home page.

During initial installation the k-agent app may need to be started manually the first time.

Basic Settings of KT-205WM

Essential First Steps

To exit the Kramer Control agent, enter the PIN (default 9428). If the PIN button is not displayed, swipe up from the bottom of the screen to bring up the PIN entry pop-up.

To re-open the Control Agent click the  icon on the Home page.

The following are essential first steps in using the touch panel:

1. **Set the device date and time;** [Setting the Date and Time](#) on page [11](#).
2. **Setup the Ethernet and/or Wi-Fi connections;** [Connecting to Wi-Fi or Ethernet](#) on page [12](#).
3. **Consider changing the time that the system checks for firmware (OS) updates;** [Changing the Automated Firmware Update](#) on page [14](#). By default, this is set to midnight, change it if you have no internet access at midnight or prefer another time.
4. **Consider changing the time that the system checks for Kramer Control (APK) updates;** [Changing the Automated Kramer Control Agent Update](#) on page [16](#). By default, this is set to midnight, change it if you have no internet access at midnight or prefer another time.
5. **Setup the Kramer Control agent;** See [Using the Kramer Control agent \(connecting to Brain\)](#) on page [18](#).
6. **Change the display language (if necessary);** [Setting the Display and Keyboard Language](#) on page [17](#).

Setting the Date and Time

The device arrives preset to New York time and you will need to set the correct time region.

To adjust the date and time settings:

1. If necessary, swipe up from the bottom of the screen to bring up the PIN entry pop-up and enter the PIN (default 9428).
2. On the Home page, press the **Settings** button . The device's **Settings** menu opens.
3. Select **Date & Time > Time zone**.
4. Set the correct **Region**. The time will display correctly.

Connecting to Wi-Fi or Ethernet

Connect an Ethernet cable to the device or activate Wi-Fi and setup a connection to your Wi-Fi. If multiple network connections are used, Ethernet will be prioritized over any others.

If you are using 802.1X authentication, do [Installing an 802.1X Certificate](#) on page [13](#), before you connect to the internet.

Connecting Ethernet

Ethernet connections must be plugged into the back of the device, see ⑧ in [Defining KT-205WM 5.5" Touch Panel](#) on page [5](#). By default, the IP address of the device is set automatically by a DHCP server.

Enabling 802.1X Authentication

1. Do [Installing an 802.1X Certificate](#) on page [13](#).
2. In the **Settings** screen, select **Network & Internet > Ethernet**.
3. Make sure the **Ethernet** is disabled and then enable **Security**.



802.1X authentication cannot be applied to active Ethernet connections

4. Select **802.1X settings** and input the **EAP** (Extensible Authentication Protocol) information. 802.1X authentication is enabled.

Using a Static IP Address

1. If necessary, swipe up from the bottom of the screen to bring up the PIN entry pop-up and enter the PIN (default 9428).
2. From the Home page, open the **Settings** screen .
3. In the Settings screen, select **Network & Internet > Ethernet**.
4. Press **Ethernet IP mode** and select **Static**.
5. Enter the IP information and press **Connect**.

The static IP address is setup.

Connecting Wi-Fi

Enabling 802.1X Authentication

1. Do [Installing an 802.1X Certificate](#) on page [13](#).
2. From the Home page, open the **Settings** screen .
3. In the Settings screen, select **Network & Internet > Wi-Fi**.
4. Make sure **Use Wi-Fi** is enabled. The device will scan and list the Wi-Fi networks.
5. Select a Wi-Fi SSID, check **Advanced options** and enter the Wi-Fi information in the fields that appear, then press **Connect**.
6. If you are using 802.1X authentication, then add the certificate information.

802.1X is enabled.

Installing an 802.1X Certificate

802.1X certificates enhance the security of network authentication. **KT-205WM** support .pem, .pfx and .p12 certificate formats.

Installing a certificate is a two-stage process: First import the certificate, then set it up.

Importing an 802.1X Certificate

1. Copy the certificate file to an empty USB flash drive.
2. If necessary, swipe up from the bottom of the screen to bring up the PIN entry pop-up and enter the PIN (default 9428).
3. From the Home page, open the **Settings** screen .
4. Select **Advanced settings > Security > Encryption & credentials**.

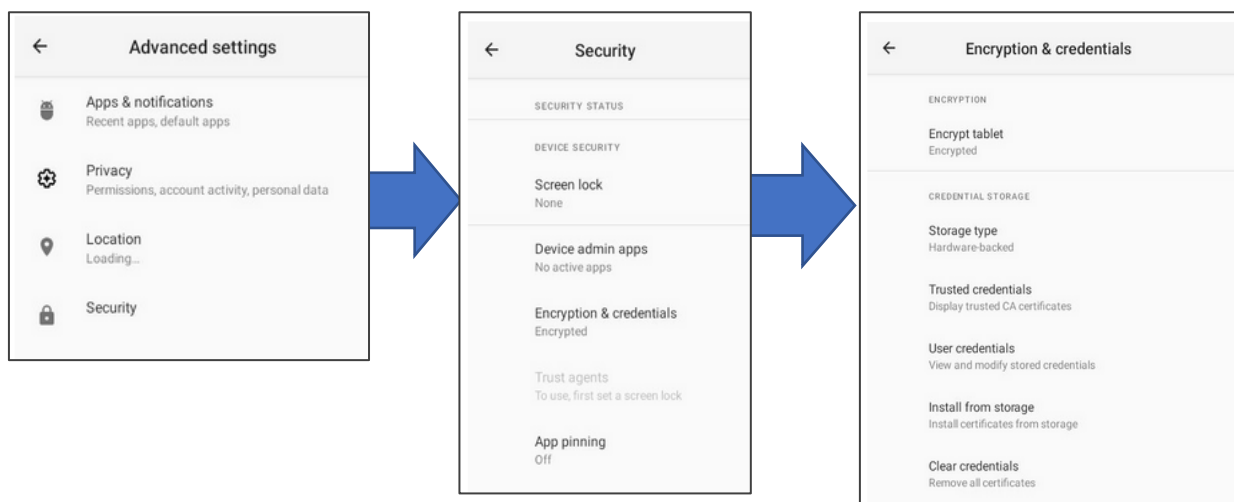



Figure 4: The path to Install from storage

5. In the Encryption & credentials screen, select **Install from storage**: The **Install a certificate** screen opens.
6. Select the **Wi-Fi certificate**: The **Recent** files screen opens.
To browse to the file location, press the 3 lines  at the top left of the screen.
7. Select the credentials file and install it, some certificates require you to know a password.
An 802.1X certificate is imported.

Setting up an 802.1X Certificate

1. In the Settings screen, select **Network & Internet > Wi-Fi**.
2. Select **Install from storage**: The **Install a certificate** screen opens.
3. Select **Wi-Fi certificate** (also for Ethernet connections): The **Recent** files screen opens.
To browse to the file location, press the 3 lines  at the top left of the screen.

802.1X certificate is set.

After installing the certificates, see [Connecting to Wi-Fi or Ethernet](#) on page [12](#) for instructions on using the certificates. Ethernet must be disabled before setting-up Ethernet certificates.

Changing the Automated Firmware Update

KT-205 arrives preset to check for firmware (touch panel OS) updates at midnight. If an update is found, the device will download the update file and install it. If you prefer to run manual updates, you must manually download the update file and then install it in the touch panel.

Changing the Time of the Firmware's Automated Update

1. If necessary, swipe up from the bottom of the screen to bring up the PIN entry pop-up and enter the PIN (default 9428).
2. From the Home page, open the **Settings** screen .
3. Select **Firmware update** and then select **Remote firmware upgrade URL**.

Remote firmware upgrade URL is the site from which the firmware is downloaded.

The upgrade URL (case sensitive):

<https://cdn.kramerav.com/web/apk/transformer-Kramer-AndroidR.xml>



Figure 5: The Firmware update page

4. A pop-up opens, inviting you to set the check time:

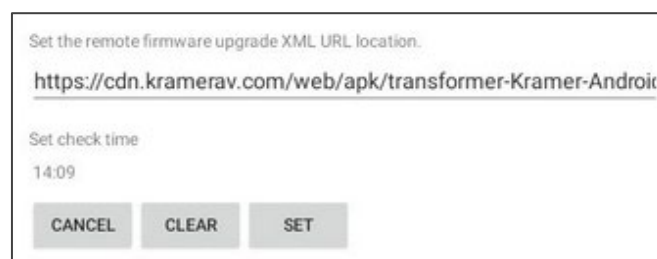

Figure 6: The Remote firmware upgrade URL page

5. To change the time that the system checks for updates, press **Set check time** and select a new time.
6. Press **OK** to close the window and then press **SET**.



Changing (or clearing) the URL will disable the updates.

The time of the automated firmware check is set.

Manually Updating the Firmware

Manual firmware updates require a downloaded firmware file from Kramer.

The firmware upgrade process requires:

- An empty USB flash drive to store the firmware file.
- A micro-USB OTG (on the go) cable to connect the USB flash drive to the touch panel.
- Access to the back of the touch panel.

You may need to remove the touch panel from its mount for this purpose. The touch panel should remain connected to a power source such as PoE or the optional power adapter (see ©in [Defining KT-205WM 5.5" Touch Panel](#) on page 5).

To upgrade the firmware:

1. Download the firmware update file from the Kramer website at www.kramerav.com/product/KT-205WM.
 - Verify that you are using the correct **KT-205WM** firmware file as there maybe more than one firmware file available.
 - Do not unzip the firmware update file.
2. Copy the firmware file to an empty USB flash drive.
3. On the touch panel, open the **Settings** screen .
4. Select **Firmware update** and then select **Firmware update** (again).
5. Plug the USB flash drive into a micro-USB OTG cable and connect the cable to the back of the touch panel.
6. Click **START FIRMWARE UPDATE**.

The firmware update will then begin.

Changing the Automated Kramer Control Agent Update

KT-205 arrives preset to check for updates to the Kramer Control Agent at midnight every day. If an update is found, the device will download the update file and install it.

Changing the time of the automated APK update check

1. If necessary, swipe up from the bottom of the screen to bring up the PIN entry pop-up and enter the PIN (default 9428).
2. From the Home page, open the **Settings** screen .
3. Select **Remote APP upgrade URL**.

Remote APP upgrade URL is the site from which the APK is downloaded.

The upgrade URL (case sensitive) is:

https://cdn.kramerav.com/web/apk/remote_app_update.xml

4. A pop-up opens, inviting you to set the check time:

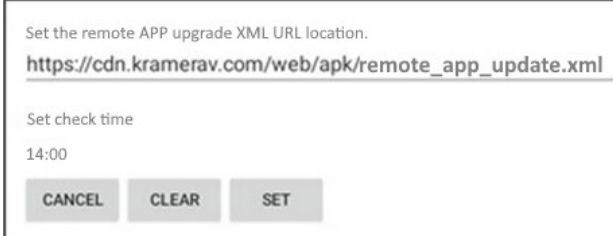

Figure 7: The Remote APP upgrade URL page

5. Press **Set check time** to select a new time.
6. Press **OK** to close the window and then press **SET**.



Changing (or clearing) the URL will disable the updates.

The time of the automated APK update check is changed.

Setting the Display and Keyboard Language

To set your preferred interface language:

1. If necessary, swipe up from the bottom of the screen to bring up the PIN entry pop-up and enter the PIN (default 9428).
2. From the Home page, open the **Settings** screen .
3. Select **Language & input**.
4. Select **Languages**.
5. Press **Add a language** to select a language.
6. If you are using multiple languages, the order in which they are listed represents the priority assigned to them, change the order by dragging languages.

The keyboard language has been set.

Using the Kramer Control agent (connecting to Brain)

The KT-205WM touch panel contains a Kramer Control agent (an app), which connects to Kramer Control. **Kramer Control's Brain** creates customized interfaces which the Kramer Control agent can display on the touch panel. The customized interfaces can control all aspects of a meeting space. For more information about **Kramer Brain**, see <https://www.kramerav.com/product/KramerControl>.

When the touch panel starts, the **Kramer Control agent** loads automatically (it is pre-installed on KT-205WM). If an interface has been defined, it will be displayed.

If this is the first time the Kramer Control app has run, then it will ask you to enter the URL & port number of the customized interface you have chosen to display.

Interface URL

The URL of the customized interface is generated by KC-Brain or by your SL-240 / SL-280 interface. The URL is always followed by a port number (and a code on SL-240 / SL-280).

The hardware section of the builder's Brain Info contains the URL (in the format IP:port#) of the customized Brain interface.

Port Numbers

Different versions of the Kramer Control Brain use different port numbers:

1. **Kramer SL-240 or SL-280:** Port 8000.
2. **KC-Virtual Brain 1:** Port 8001.
3. **KC-Virtual Brain 5:** Ports 8001 – 8005 (KC-Virtual Brain 5 can define up to 5 different touch pad control interfaces, each will use a different port).

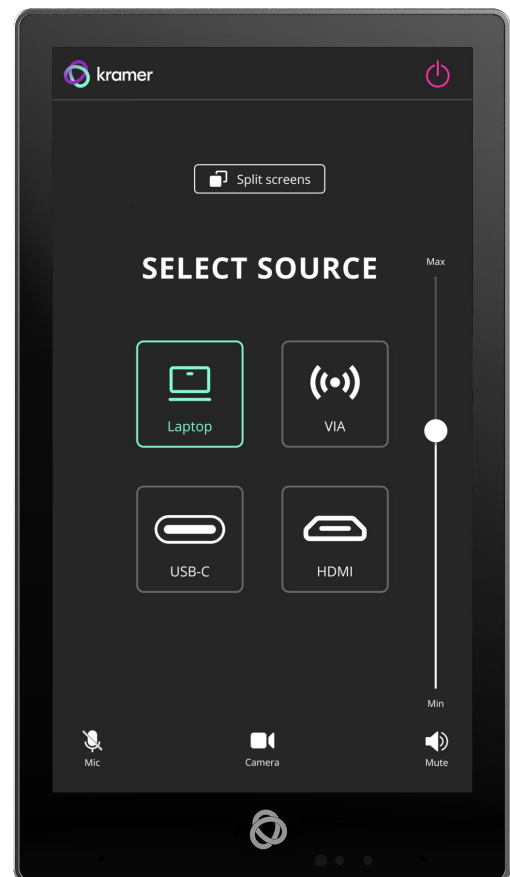

Figure 8: Example of a touch panel interface menu

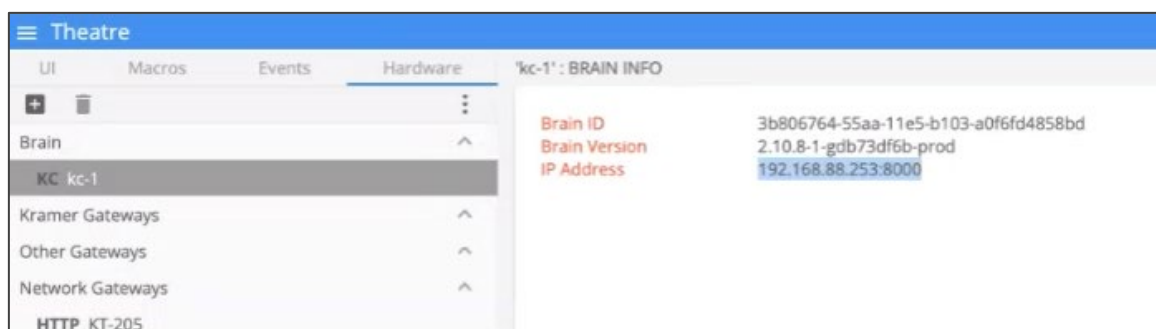

Figure 9: Interface IP Address

Updating the interface URL in the Kramer Control agent

There are 3 possible methods of updating the interface URL in the Kramer Control agent:

1. In the Kramer Control agent (on the touch panel screen).
2. In a web browser (on a remote computer connected to the same network).
3. In the Brain software (setting up the touch panel in the Brain software).

Any one of these methods can load the interface URL into the touch panel's Kramer Control agent.

1. Entering the interface URL in the Kramer Control agent

- a. Kramer Control agent opens automatically when the touch panel starts. If no interface URL has been entered, this is how the screen looks:

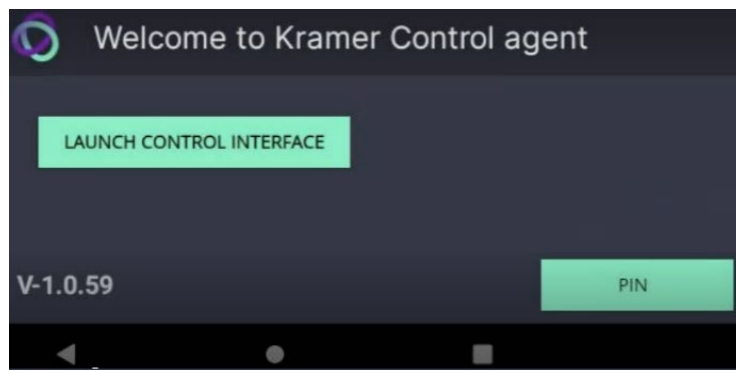



Figure 10: Touch panel running the Kramer Control agent

- If the touch panel is not displaying the Kramer Control agent, open the **Kramer Agent** app  from the touch panel's Home page.
- b. Press LAUNCH CONTROL INTERFACE, the URL entry pop-up appears.

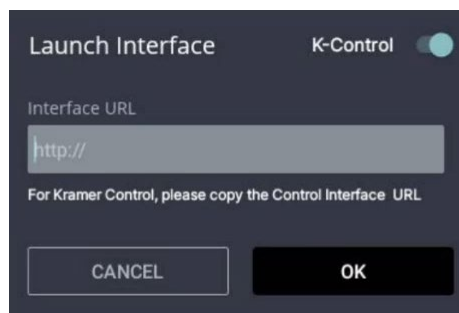

Figure 11: Kramer Control agent, URL entry pop-up

- c. Enter the IP address and port of the interface that was defined in Kramer Brain, for example <https://192.168.88.180:8001>.
- d. By default, the K-Control slider is on, setting the tablet in “Immersive Mode”. In Immersive (full screen) mode, the system bars are hidden and users can exit the interface only by swiping up and entering a PIN. Immersive mode is recommended for the Kramer Control interface; Disable it if you are using a generic webpage.
- e. Press OK and the touch panel will load your interface. To exit the interface and access touch panel controls, slide your fingers up from the bottom of the screen and enter the PIN (default 9428).

2. Entering the Kramer Control URL from a browser on the same network

The following is an alternative method to setting the Kramer Control link on the touch panel. This procedure can be done remotely, without using the touch panel.

Note: The touch panel must be switched on and connected to the same LAN.

- a) Open a browser window on a computer connected to the same network as the touch panel.
- b) Enter the interface URL in the following format:

https://<IP of the touch panel>:9804/launchkramerurl?<IP of the brain interface>:<port #>

For example: if the touch panel's IP is 192.168.0.56 and the Brain interface's IP is "192.168.22.53:8001", then you would enter

`https://192.168.0.56:9804/launchkramerurl?192.168.22.53:8001`

Note: The touch panel port (on the first URL) is 9803 for http and 9804 for https.

If there is more than one interface on the brain it is recommended to copy and paste the highlighted portion of the URL from a browser tab showing the correct interface.

After this command is sent, the touch pad will display the Brain-defined interface.

The following interface commands for the touch panel can be sent from a browser:

- a) Check if the agent is running: *https://<IP of the touch panel>:9804/health/*
Successful response: `{"Status": "up"}`
- b) Reboot the touch panel: *https://<IP of the touch panel>:9804/reboot/*
Successful response: `{"Status": "Rebooting"}`
- c) Clear the interface URL definition in the Control app:
https://<IP of the touch panel>:9804/reseturl/
Successful response: `{"Status": "URL is reset now"}`
- d) Define a new interface URL:
https://<IP of the touch panel>:9804/launchkramerurl?<IP of the interface>:<port#>
Successful response: `Browser will be launched with given URL.`
- e) Define a generic URL (have the touch panel display a non-Brain URL such as *https://www.google.com*): *https://<IP of the touch panel>:9804/launchurl?<full generic URL>*
Successful response: `Browser will be launched with given URL.`

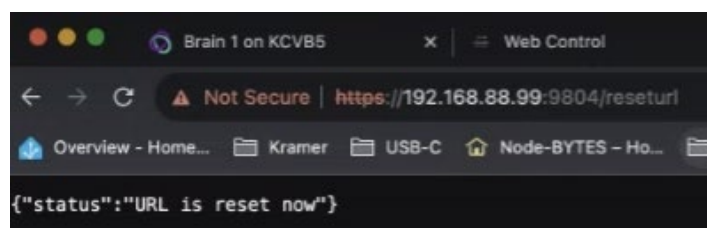

Figure 12: Example of a successful response message.

3. Setup the touch panel in the Brain Builder

The advantage of this method is that once defined, any changes to the interface are automatically uploaded to the tablet.

The following assumes that:

- The interface is already setup in the Brain.
- The touch panel is active and connected to the same network as the Brain.
- The IP of the touch panel is static and DHCP assigned.

- Preliminary Setup:** In the **Devices** tab of the Builder screen, add the **K-Agent** driver as a device. It must be assigned to the same network gateway as the touch panel.
- Navigate to the Brain** control page on your computer.
- Select the interface** that you want to use on the touch panel.
- Copy the interface's URL** from the address bar (see the image below).

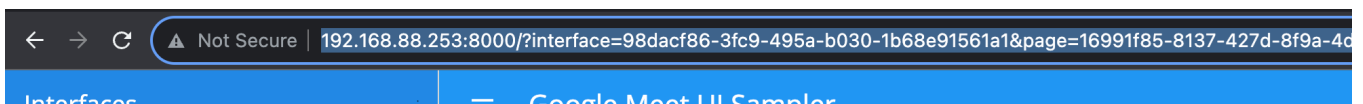

- Navigate back to the Builder, double click on the touch panel (in the **Devices** list) and paste the URL from the previous step to the **Kramer Control URL**. Assign it a **Friendly Name**.

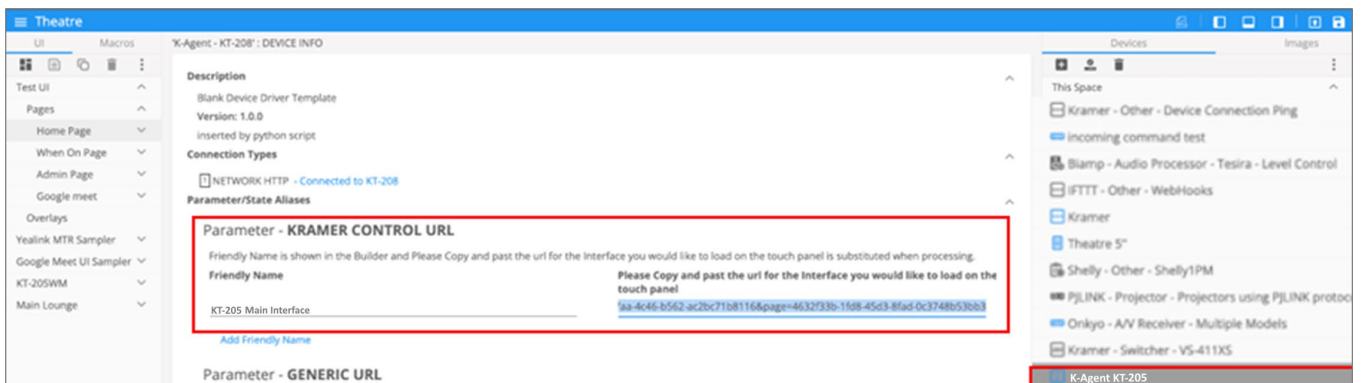

Figure 13: Kramer Control URL in the Builder

- For the Brain to be able to automatically assign the user interface to the touch panel:

(see the image on the next page)

- In the **Events** tab, click **System Events** and select "Initialization".
- Drag the **Launch Kramer URL** command to the 'Initialization' ACTIONS area.
- Select the **Friendly Name** (If only one interface is defined, it will be used by default).

The screenshot displays the Theatre control interface. The main window is titled "Initialization": TRIGGER and is divided into several sections:

- TRIGGER:** This event occurs when the Brain enters the active stage. State: Active. This event happens when the user performs a restart or publish.
- ACTIONS:**
 - Command: Query Volume Level on Onkyo - A/V Receiver - Multiple Models
 - VOLUME ZONE = Main Zone
 - Command: Query Mute on Onkyo - A/V Receiver - Multiple Models
 - MUTE ZONE = Main Zone
 - Command: Query Power State on Onkyo - A/V Receiver - Multiple Models
 - POWER ZONE = Main Zone
 - Command: Launch Kramer URL on K-Agent - KT-2010 (highlighted with a red arrow)
 - Command: Launch Kramer URL on K-Agent - KT-2010
 - Delay: 10 seconds
- PROPERTIES:**

Name	Launch Kramer UI
Interfaces Supported	HTTP
Dynamic Parameters	None
Static Parameters	None

The right-hand side of the interface shows a list of devices under "This Space", including System Virtual Lock, Shelly, PJLINK, Onkyo, Kramer, and K-Agent devices. The "Launch Kramer URL" command is selected in the "Commands" list.

Figure 14: System Events window open on Initialization actions

- Every time the Brain reboots or connects to the touch panel the interface will be updated.

Advanced Settings

Factory Reset & Reboot

The **Settings > Reset** options menu enables you to perform a factory reset or to reboot the device, reset Wi-Fi or Bluetooth or reset app preferences.

Resetting to Factory Default Parameters

To reset the device to its factory default settings:

1. If necessary, swipe up from the bottom of the screen to bring up the PIN entry pop-up and enter the PIN (default 9428).
2. From the Home page, open the **Settings** screen .
3. Select **Reset options > Erase all data (factory reset)**.
4. Press **Erase all data**.

Other options available are Reboot device, Reset Wi-Fi, mobile & Bluetooth and Reset app preferences.

Resetting with the External Reset Button

Insert a pin into the pinhole on the back ③ (see [Defining KT-205WM 5.5" Touch Panel](#) on page 5) and hold for 22 seconds to reset the device to factory default values.

A second pinhole on the top ② restarts the device when a pin is inserted for a few seconds.

Logging Activity

By default, the device does not log activity. Logging can be useful for debugging or monitoring use.

Activating Logging

To activate logging:

1. If necessary, swipe up from the bottom of the screen to bring up the PIN entry pop-up and enter the PIN (default 9428).
2. From the Home page, open the **Settings** screen .
3. Select **Log > Log Location** and select one of Store to internal storage, Store to SD card or Do not store.

Logging is activated.

Accessing an Internally Stored Log File

A USB flash drive and OTG cable are required to copy an internally stored log file.

To access an internally stored log file:

1. In the root directory of the flash drive, create a folder called “**_dump_debug_log**”.
2. Connect the OTG cable to the micro-USB connection on the back of the device.
3. Connect the flash drive to the OTG cable.
4. The device will automatically download the log file to the USB device and issue a confirmation message “**Saved log file to USB storage**”.

The log is accessed.

Technical Specifications

Ports	1 Micro USB	On a Micro USB (AB) OTG connector
	1 Ethernet	On an RJ-45 female connector, 10/100/1000M with PoE 802.3at
Platform	Operating System	Android Version 11
	CPU	ARM Quad Core Cortex-A53 up to 1.8Ghz (64 bit)
Memory	RAM	LPDDR4 2GB
	Internal	32GB eMMC (flash)
Display	Touch Panel Type	Multi-touch
	Size	5.5"
	Resolution	720x1280 RGB pixels 350cd/m2 brightness, 1000:1 contrast ratio
Wireless Connectivity	Wi-Fi	Wi-Fi 6, 802.11 a/b/g/n/ax/ax
	Bluetooth	BT 5.0
Video	Video Formats	H.264, H.265, VC-1, MPEG-4, VP8, VP9
	Image Codecs	JPEG, BMP, GIF, PNG
Audio	Speakers	1x 1W
	Codecs	MPEG, OGG, AAC
	Microphone	2 built-in.
Power	PoE (Power over Ethernet)	44 to 57VDC 0.3A Complies with IEEE 802.3af PoE standard
	Optional Power Adapter	12V 1A DC
Controls	Restart	On top, recessed
	Restore factory settings	On back, recessed
	Home	In top
LED	Side-light	Can indicate room status (requires 3 rd party integration).
Environmental conditions	Operating Temperature	0~40°C (32~104°F)
	Storage Temperature	-20~60°C
	Operating Humidity	5% to 85%
	Storage Humidity	5% to 90%
Regulatory Compliance	Safety	CE, FCC, UL, UKCA
	Environmental	RoHs, WEEE
Dimensions	Touch Panel (W,D,H)	81mm x 25mm x 143mm / 3.15" x 0.98" x 5.63"
	Wall Mount	1 gang
Weight	Touch Panel	0.2kg / 0.4lbs (approximate)
Shipping carton	Dimensions (W,D,H)	148mm x 78mm x 235mm / 5.83" x 3.07" x 9.25"
	Weight	0.5kg / 1.1lbs (approximate)
Accessories	Optional	Power adapter.
	Included	On-wall mount unit and screws
Specifications are subject to change without notice at www.kramerav.com		

The warranty obligations of Kramer Electronics Inc. ("Kramer Electronics") for this product are limited to the terms set forth below:

What is Covered

This limited warranty covers defects in materials and workmanship in this product.

What is Not Covered

This limited warranty does not cover any damage, deterioration or malfunction resulting from any alteration, modification, improper or unreasonable use or maintenance, misuse, abuse, accident, neglect, exposure to excess moisture, fire, improper packing and shipping (such claims must be presented to the carrier), lightning, power surges, or other acts of nature. This limited warranty does not cover any damage, deterioration or malfunction resulting from the installation or removal of this product from any installation, any unauthorized tampering with this product, any repairs attempted by anyone unauthorized by Kramer Electronics to make such repairs, or any other cause which does not relate directly to a defect in materials and/or workmanship of this product. This limited warranty does not cover cartons, equipment enclosures, cables or accessories used in conjunction with this product.

Without limiting any other exclusion herein, Kramer Electronics does not warrant that the product covered hereby, including, without limitation, the technology and/or integrated circuit(s) included in the product, will not become obsolete or that such items are or will remain compatible with any other product or technology with which the product may be used.

How Long this Coverage Lasts

The standard limited warranty for Kramer products is seven (7) years from the date of original purchase, with the following exceptions:

1. All Kramer VIA hardware products are covered by a standard three (3) year warranty for the VIA hardware and a standard three (3) year warranty for firmware and software updates; all Kramer VIA accessories, adapters, tags, and dongles are covered by a standard one (1) year warranty.
2. Kramer fiber optic cables, adapter-size fiber optic extenders, pluggable optical modules, active cables, cable retractors, ring mounted adapters, portable power chargers, Kramer speakers, and Kramer touch panels are covered by a standard one (1) year warranty. Kramer 7-inch touch panels purchased on or after April 1st, 2020 are covered by a standard two (2) year warranty.
3. All Kramer Calibre products, all Kramer Minicom digital signage products, all HighSecLabs products, all streaming, and all wireless products are covered by a standard three (3) year warranty.
4. All Sierra Video MultiViewers are covered by a standard five (5) year warranty.
5. Sierra switchers & control panels are covered by a standard seven (7) year warranty (excluding power supplies and fans that are covered for three (3) years).
6. K-Touch software is covered by a standard one (1) year warranty for software updates.
7. All Kramer passive cables are covered by a lifetime warranty.

Who is Covered

Only the original purchaser of this product is covered under this limited warranty. This limited warranty is not transferable to subsequent purchasers or owners of this product.

What Kramer Electronics Will Do

Kramer Electronics will, at its sole option, provide one of the following three remedies to whatever extent it shall deem necessary to satisfy a proper claim under this limited warranty:

1. Elect to repair or facilitate the repair of any defective parts within a reasonable period of time, free of any charge for the necessary parts and labor to complete the repair and restore this product to its proper operating condition. Kramer Electronics will also pay the shipping costs necessary to return this product once the repair is complete.
2. Replace this product with a direct replacement or with a similar product deemed by Kramer Electronics to perform substantially the same function as the original product. If a direct or similar replacement product is supplied, the original product's end warranty date remains unchanged and is transferred to the replacement product.
3. Issue a refund of the original purchase price less depreciation to be determined based on the age of the product at the time remedy is sought under this limited warranty.

What Kramer Electronics Will Not Do Under This Limited Warranty

If this product is returned to Kramer Electronics or the authorized dealer from which it was purchased or any other party authorized to repair Kramer Electronics products, this product must be insured during shipment, with the insurance and shipping charges prepaid by you. If this product is returned uninsured, you assume all risks of loss or damage during shipment. Kramer Electronics will not be responsible for any costs related to the removal or re-installation of this product from or into any installation. Kramer Electronics will not be responsible for any costs related to any setting up this product, any adjustment of user controls or any programming required for a specific installation of this product.

How to Obtain a Remedy Under This Limited Warranty

To obtain a remedy under this limited warranty, you must contact either the authorized Kramer Electronics reseller from whom you purchased this product or the Kramer Electronics office nearest you. For a list of authorized Kramer Electronics resellers and/or Kramer Electronics authorized service providers, visit our web site at www.kramerav.com or contact the Kramer Electronics office nearest you.

In order to pursue any remedy under this limited warranty, you must possess an original, dated receipt as proof of purchase from an authorized Kramer Electronics reseller. If this product is returned under this limited warranty, a return authorization number, obtained from Kramer Electronics, will be required (RMA number).

You may also be directed to an authorized reseller or a person authorized by Kramer Electronics to repair the product.

If it is decided that this product should be returned directly to Kramer Electronics, this product should be properly packed, preferably in the original carton, for shipping. Cartons not bearing a return authorization number will be refused.

Limitation of Liability

THE MAXIMUM LIABILITY OF KRAMER ELECTRONICS UNDER THIS LIMITED WARRANTY SHALL NOT EXCEED THE ACTUAL PURCHASE PRICE PAID FOR THE PRODUCT. TO THE MAXIMUM EXTENT PERMITTED BY LAW, KRAMER ELECTRONICS IS NOT RESPONSIBLE FOR DIRECT, SPECIAL, INCIDENTAL OR CONSEQUENTIAL DAMAGES RESULTING FROM ANY BREACH OF WARRANTY OR CONDITION, OR UNDER ANY OTHER LEGAL THEORY. Some countries, districts or states do not allow the exclusion or limitation of relief, special, incidental, consequential or indirect damages, or the limitation of liability to specified amounts, so the above limitations or exclusions may not apply to you.

Exclusive Remedy

TO THE MAXIMUM EXTENT PERMITTED BY LAW, THIS LIMITED WARRANTY AND THE REMEDIES SET FORTH ABOVE ARE EXCLUSIVE AND IN LIEU OF ALL OTHER WARRANTIES, REMEDIES AND CONDITIONS, WHETHER ORAL OR WRITTEN, EXPRESS OR IMPLIED. TO THE MAXIMUM EXTENT PERMITTED BY LAW, KRAMER ELECTRONICS SPECIFICALLY DISCLAIMS ANY AND ALL IMPLIED WARRANTIES, INCLUDING, WITHOUT LIMITATION, WARRANTIES OF MERCHANTABILITY AND FITNESS FOR A PARTICULAR PURPOSE. IF KRAMER ELECTRONICS CANNOT LAWFULLY DISCLAIM OR EXCLUDE IMPLIED WARRANTIES UNDER APPLICABLE LAW, THEN ALL IMPLIED WARRANTIES COVERING THIS PRODUCT, INCLUDING WARRANTIES OF MERCHANTABILITY AND FITNESS FOR A PARTICULAR PURPOSE, SHALL APPLY TO THIS PRODUCT AS PROVIDED UNDER APPLICABLE LAW. IF ANY PRODUCT TO WHICH THIS LIMITED WARRANTY APPLIES IS A "CONSUMER PRODUCT" UNDER THE MAGNUSON-MOSS WARRANTY ACT (15 U.S.C.A. §2301, ET SEQ.) OR OTHER APPLICABLE LAW, THE FOREGOING DISCLAIMER OF IMPLIED WARRANTIES SHALL NOT APPLY TO YOU, AND ALL IMPLIED WARRANTIES ON THIS PRODUCT, INCLUDING WARRANTIES OF MERCHANTABILITY AND FITNESS FOR THE PARTICULAR PURPOSE, SHALL APPLY AS PROVIDED UNDER APPLICABLE LAW.

Other Conditions

This limited warranty gives you specific legal rights, and you may have other rights which vary from country to country or state to state.

This limited warranty is void if (i) the label bearing the serial number of this product has been removed or defaced, (ii) the product is not distributed by Kramer Electronics or (iii) this product is not purchased from an authorized Kramer Electronics reseller. If you are unsure whether a reseller is an authorized Kramer Electronics reseller, visit our web site at www.kramerav.com or contact a Kramer Electronics office from the list at the end of this document.

Your rights under this limited warranty are not diminished if you do not complete and return the product registration form or complete and submit the online product registration form. Kramer Electronics thanks you for purchasing a Kramer Electronics product. We hope it will give you years of satisfaction.



HDMI™
HIGH-DEFINITION MULTIMEDIA INTERFACE



P/N: 2900-301657



Rev: 2



SAFETY WARNING

Disconnect the unit from the power supply before opening and servicing

For the latest information on our products and a list of Kramer distributors, visit our website where updates to this user manual may be found.

We welcome your questions, comments, and feedback.

The terms HDMI, HDMI High-Definition Multimedia Interface, and the HDMI Logo are trademarks or registered trademarks of HDMI Licensing Administrator, Inc. All brand names, product names, and trademarks are the property of their respective owners.