

Beamforming Microphone

Operating Instructions Software Version 1.00

Before operating the unit, please read this manual thoroughly and retain it for future reference.

MAS-A100

Table of Contents

Overview

Using This Manual	3
Features	4
Location and Function of Parts	4
Installation, Connection, and Configuration Process Flow	5
System Configuration Example	6

Installation and Connection

Installing	7
Before Installing	7
Direct Mounting	7
Mounting Using an Existing Junction Box	7
Mounting Screws	7
Attaching	8
Detaching	9
Connecting	9

Initial Setup

Setting Up a Computer	10
Accessing the Unit from a Web Browser	10
Configuring Initial Setup Items	11

Configuration (Device Settings)

Screen Structure	14
Basic Operations in the Device Settings Menu	15
[Information] Page	15
[Audio] Page	16
Audio Settings	16
Calibration	16
[Network] Page	17
[Security] Page	18
[User] tab	18
[Access] tab	18
[SSL] tab	19
[Referer] tab	21
[External System] Page	21
[System] Page	22
[Device info] tab	22
[Option] tab	22
[Date & Time] tab	23
[Maintenance] Page	24

[Restart/Log] tab	24
[Update] tab	24
[Legal] Page	25
[EULA] tab	25
[Software] tab	25

Operation

Appendix

Usage Precautions	27
Indicator/Message List	28
LED indicators	28
Web browser display	28
Troubleshooting	29
About Use of GNU GPL/LGPL Software ...	30
Specifications	30
Dimensions (main unit)	31
Dimensions (ceiling bracket)	32

Overview

Safety Regulations (supplied)

Describes the important points for safe use of the unit.

Be sure to read it.

Operating Instructions (This document/ Web)

These operating instructions describe the names of the various parts of the unit, and installation, connection, and operation methods.

Help Guide

Describes the screen items and functions of the MASM-1 Microphone Array System Manager.

System Integration Guide

Describes important information about the system design, configuration, and operation of the unit and related devices.

Using This Manual

The Operating Instructions document is designed to be read on a computer display. The content you need to know in order to use the unit is described here.

Read it before you operate the unit.

Jumping to a related page

When you read the instructions on a computer display and click on the related part of the relevant page that is being displayed, you jump to the related page. Relevant pages can be searched easily.

Software display examples

The software displays described in this manual are explanatory examples. Note that some displays may be different from the ones that actually appear.

Printing the Operating Instructions

Depending on your system, certain displays or illustrations in the Operating Instructions, when printed out, may differ from those that appear on your screen.

NOTICE TO USERS

© 2020 Sony Corporation.

All rights reserved. This manual or the software described herein, in whole or in part, may not be reproduced, translated or reduced to any machine readable form without prior written approval from Sony Corporation.

SONY CORPORATION PROVIDES NO WARRANTY WITH REGARD TO THIS MANUAL, THE SOFTWARE OR OTHER INFORMATION CONTAINED HEREIN AND HEREBY EXPRESSLY DISCLAIMS ANY IMPLIED WARRANTIES OF MERCHANTABILITY OR FITNESS FOR ANY PARTICULAR PURPOSE WITH REGARD TO THIS MANUAL, THE SOFTWARE OR SUCH OTHER INFORMATION. IN NO EVENT SHALL SONY CORPORATION BE LIABLE FOR ANY INCIDENTAL, CONSEQUENTIAL OR SPECIAL DAMAGES, WHETHER BASED ON TORT, CONTRACT, OR OTHERWISE, ARISING OUT OF OR IN CONNECTION WITH THIS MANUAL, THE SOFTWARE OR OTHER INFORMATION CONTAINED HEREIN OR THE USE THEREOF. Sony Corporation reserves the right to make any modification to this manual or the information contained herein at any time without notice. The software described herein may also be governed by the terms of a separate user license agreement.

- Audinate®, the Audinate logo and Dante® are registered trademarks of Audinate Pty Ltd.
- Microsoft, Windows, and Internet Explorer are registered trademarks of United States Microsoft Corporation in the United States and/or other countries.
- JavaScript is a trademark or registered trademark of Oracle Corporation, its affiliates or subsidiaries in the United States and other countries.
- Google Chrome is a registered trademark of Google Inc.

Other system names, product names appearing in this document are trademarks or registered trademarks of their respective manufacturers. Trademarked items are not indicated by ® or ™ symbols in this document.

Features

The MAS-A100 is a beamforming type, ceiling-mounted microphone with a speech reinforcement and clear audio recording system for hands-free, hassle-free operation covering locations over a wide area.

Lecturers and presenters can use both hands freely when giving lectures and presentations, without troublesome preparation and equipment operation.

The unit also supports Dante audio transmission and power supply from a PoE switching hub. It can be connected to various audio systems using a single network cable.

Location and Function of Parts

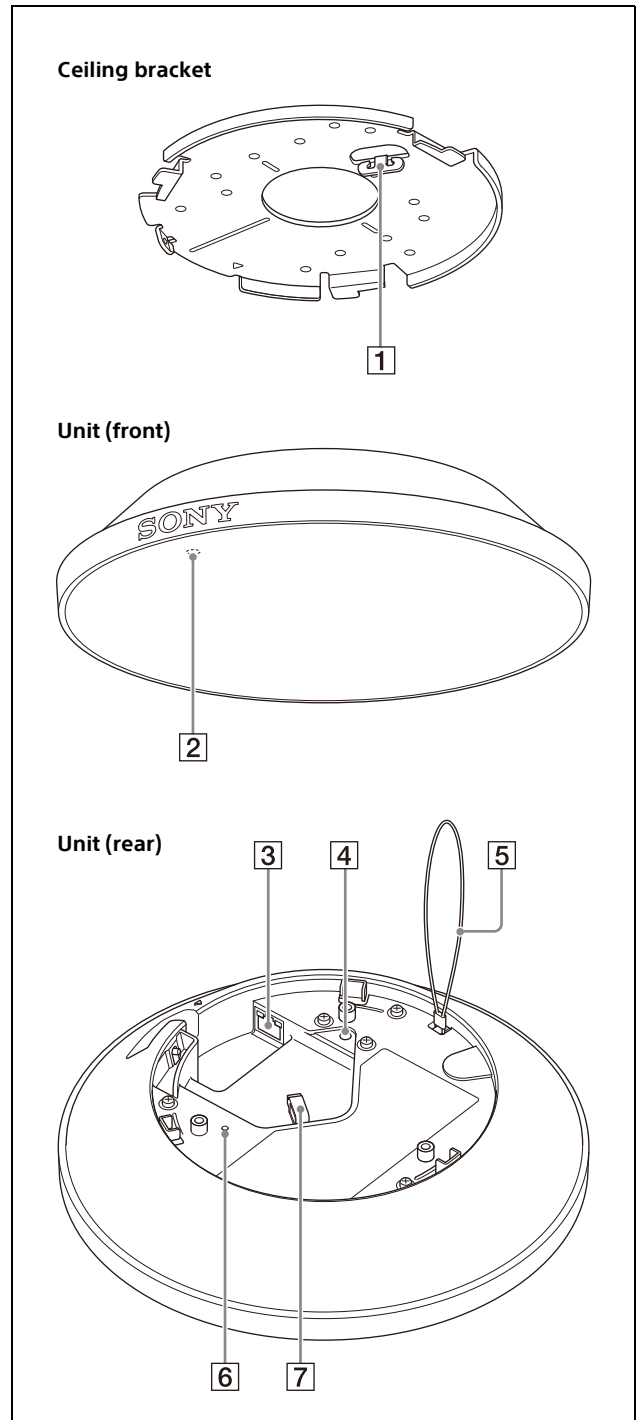

- 1 Hook**
Hooks to the internal wire rope of the main unit.
For details, see "Installing" (page 7).
- 2 LED (STATUS lamp)**
Lights up when power is supplied to the unit. You can turn the LED off, even when the unit is powered. You can also change the color of the LED when it is lit (page 22).

If the LED starts flashing alternately between green and red, contact your Sony service representative.

- 3  **LAN (network) connector (RJ-45)**
Connect to a 100BASE-TX or 1000BASE-T compatible PoE switching hub using a LAN cable (100/1000BASE-T Cat5e UTP or higher). The unit turns on when the cable is connected, and turns off when the cable is disconnected.

Note

For safety, do not connect the connector for peripheral device wiring that might have excessive voltage to this port. Follow the instructions for this port.

- 4 **Screw hole for ground connection**
Connect the ground wire.
For details, see "Installing" (page 7).
- 5 **Internal wire rope**
Wire for preventing the unit from falling from the ceiling.
For details about attaching, see "Installing" (page 7).
- 6 **Reset switch**
Insert the tip of a thin object, such as a paper clip, into the hole and press the internal switch for 10 seconds or longer to reset the settings to their factory defaults.
You can also reset the unit using [Initialize] on the [Maintenance] page.
- 7 **Cable holder**
Use to secure the LAN cable.
For details, see "Installing" (page 7).

Installation, Connection, and Configuration Process Flow

Install, connect, and configure the unit using the following sequence of steps.

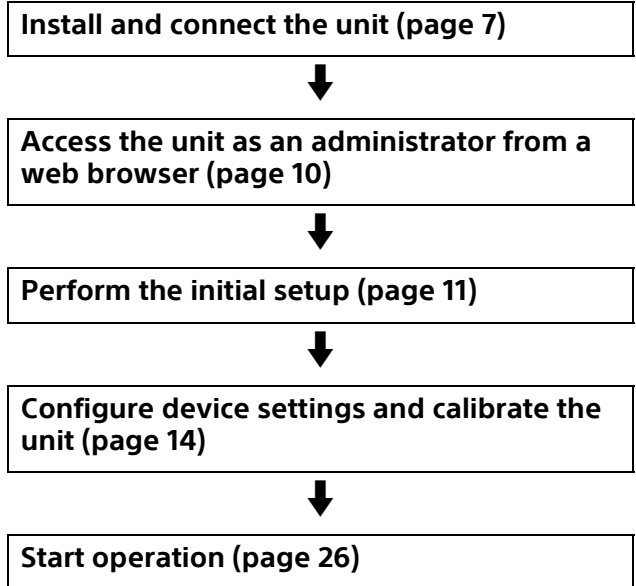

System Configuration Example

The diagram below shows a typical system configuration.

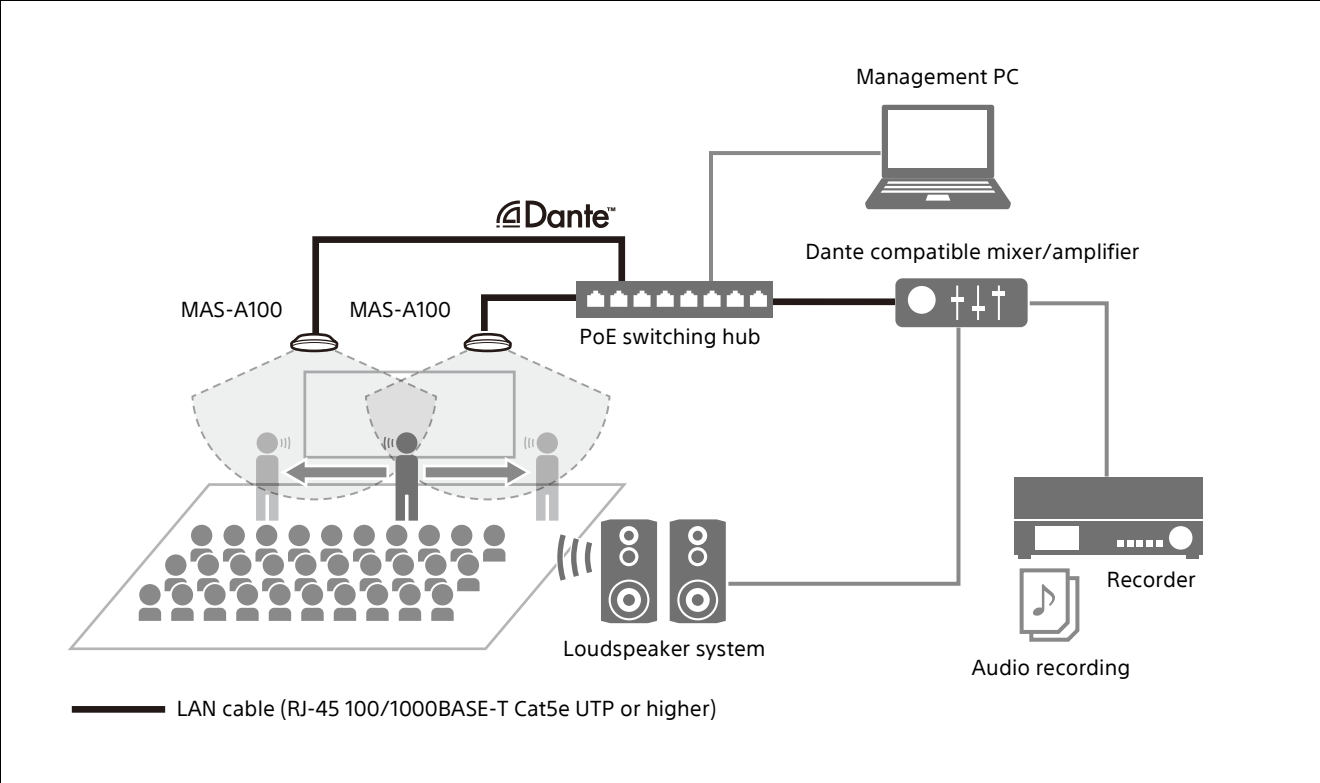

Installing

Use the supplied ceiling bracket to mount the unit.

WARNING

- To mount the unit in a high location, such as a ceiling, ask a professional contractor.
- When installing in a high location, make sure that the installation area and mounting surface material (excluding the supplied accessories) are strong enough to withstand the weight of the unit and the mounting bracket. If the surface is not strong enough, the unit may fall and cause serious injury.
- Be sure to hook the internal wire rope of the unit to the ceiling bracket to prevent the unit from falling.
- After installation in a high location, check that the installation has not become loose at least once a year. Also, shorten the inspection interval according to the usage conditions.

Note

Do not mount the unit outdoors.

Before Installing

Choose the installation orientation such that the SONY logo of the unit is facing the front, and then drill wiring holes and screw holes as necessary.

Direct Mounting

Mark the positions of the wiring hole ($\phi 50$ mm (2 in)) and ceiling bracket mounting holes (three places) using the supplied template, and then drill the holes and mount the ceiling bracket.

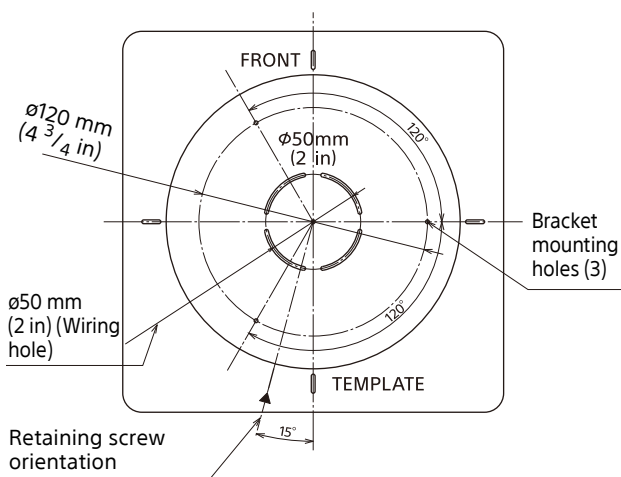

Mounting Using an Existing Junction Box

You can mount the ceiling bracket to an existing junction box, depending on the type of junction box. Screws are not supplied.

Mount the ceiling bracket so that the thick line in the figure below is at the back of the unit.

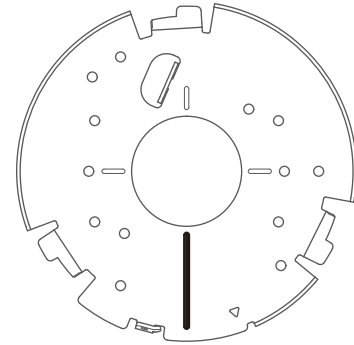

Mounting Screws

The recommended screws to use (not supplied) will vary depending on the installation location and surface material.

Metal: Secure using M4 screws and nuts.

Wood: Secure using self-tapping screws (approx. $\phi 4$ mm). The surface thickness must be 15 mm or thicker.

Concrete: Secure using a cladding surface or plug bolts.

Junction box: Secure using screws matching the screw holes in the junction box.

WARNING

Use appropriate mounting screws for the mounting location and surface material. If appropriate mounting screws are not used, the unit may fall and cause serious injury.

Attaching

- 1 Hook the internal wire rope of the main unit around the hook of the ceiling bracket.

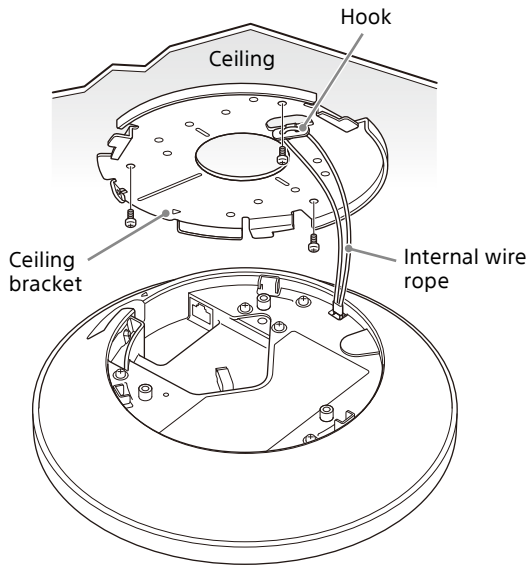

Notes

- Securely attach the internal wire rope to the hook.
- Take care not to twist the internal wire rope.

- 2 Connect the LAN cable and ground wire to the unit.

Insert the ground wire (not supplied) under the washer of a ground connection screw (not supplied), and secure in position.

Ground connection screw: M4 screw (maximum thread length of 6 mm)

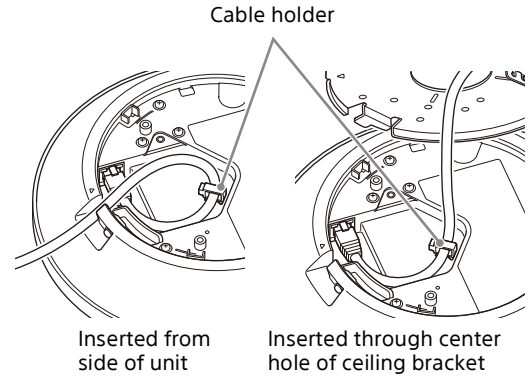
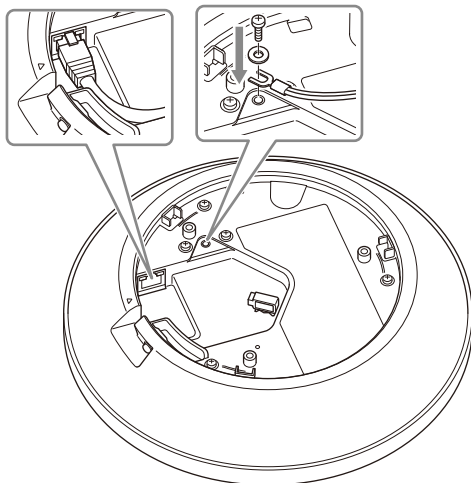

Notes

- You can work with the unit hanging from the ceiling bracket, but do not apply excessive force.
- The LAN cable can be inserted from the side of the unit or through the hole in the center of the ceiling bracket. In either case, be sure to secure the cable in the cable holder.
- Cables that are thick or which have a boot covering the connector may not be connectable.

- 3 Align the Δ mark on the unit with the Δ hole in the ceiling bracket, and insert the unit into the ceiling bracket.

- 4 Turn the unit clockwise.

- 5 Secure the unit in the ceiling bracket using the retaining screw.

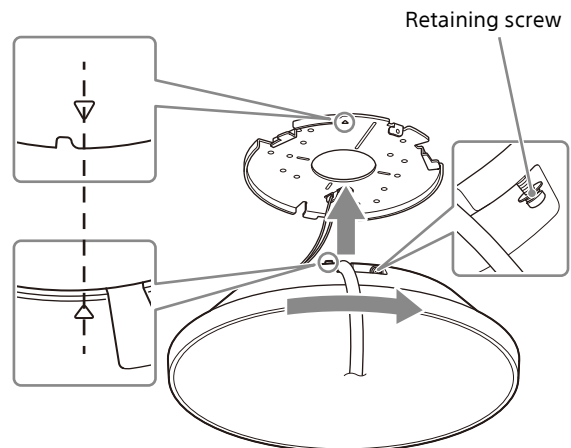

Notes

- The screw cannot be removed from the unit.
- If the screw cannot be reached, make sure the unit is securely inserted in the ceiling bracket.

Detaching

- 1 Loosen the retaining screw until the unit can be turned.

Note

The screw cannot be removed from the unit.

- 2 Turn the unit counterclockwise, and pull it out of the ceiling bracket.

- 3 Disconnect the cables.

Note

You can work with the unit hanging from the ceiling bracket, but do not apply excessive force.

- 4 Unhook the internal wire rope of the main unit from the ceiling bracket.

Note

Hold the unit when removing it from the ceiling bracket. There is a risk of the unit falling.

Connecting

Connect the other end of the LAN cable connected to the unit to a PoE switching hub. The power source of the unit can be supplied from a IEEE802.3af PoE Class 0 device.

Initial Setup

Perform the following configuration when starting the unit for the first time. This configuration is performed by the administrator.

Setting Up a Computer

Prepare a computer and connect it to the network. The recommended operating environment is given below.

OS: Windows 10 (64-bit version)

Web browser: Google Chrome Ver. 70 or later

Display resolution: 1024×768 or higher

Notes

- Turn off tablet mode.
- Do not use the Back button of the browser.
- JavaScript is used for the web page display when accessing the unit. The web page may not display correctly if your computer uses certain software, such as anti-virus software.

Accessing the Unit from a Web Browser

Perform the following configuration to enable access of the unit from a web browser. The MASM-1 Microphone Array System Manager and Dante Controller are required for configuration. For details, refer to the System Integration Guide.

Note

User name and password authentication is required to access the unit. The factory default user name and password of the unit are given below.

User name: admin

Password: Admin_1234

Configuring Initial Setup Items

The [Initial Setup] screen appears when you access the unit as an administrator. Configure the unit using the following procedure.

Notes

- Be sure to change the user name and password used when you first access the unit during the initial setup.
- If the network settings are changed, access the unit again using the changed network information.

1 Check the contents of the EULA (End User License Agreement).

2 Click the [AGREE AND START] button.

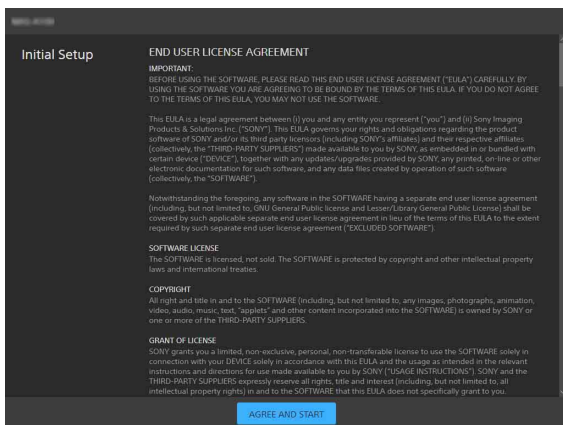

3 Select the language to use.

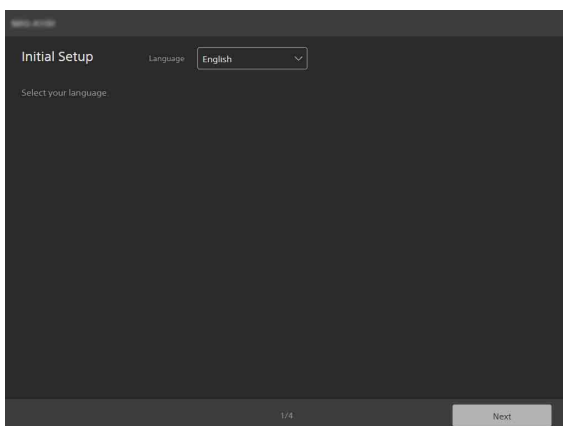

You can select [English], [French], [German], [Spanish], [Chinese], or [Japanese]. After selecting a language, the display switches to the selected language.

4 When finished, click the [Next] button.

5 Specify the administrator account name and password.

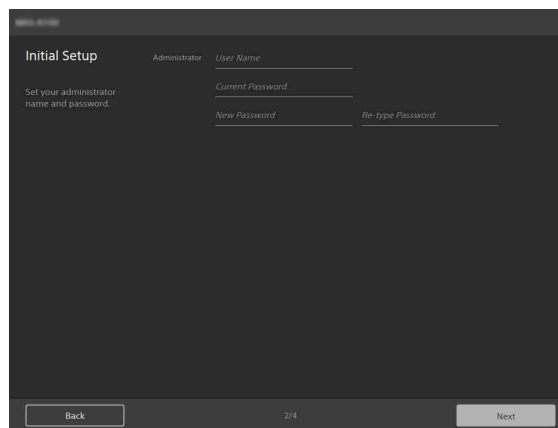

[User Name]: Enter an administrator user name comprising 5 to 16 characters.

[Current Password]: Enter the currently configured password comprising 8 to 64 characters.

[New Password]: Enter the new password you want to set comprising 8 to 64 characters.

[Re-type Password]: Re-enter the new password you want to set to verify the password.

Note

The following characters are valid in user names and passwords. Include at least one upper-case letter, one lower-case letter, and one number in passwords.

- Alphanumeric characters
- Symbols (!\$%')=--^|@`[{}]_/?<>+*.)

6 When finished, click the [Next] button.

7 Configure network settings.

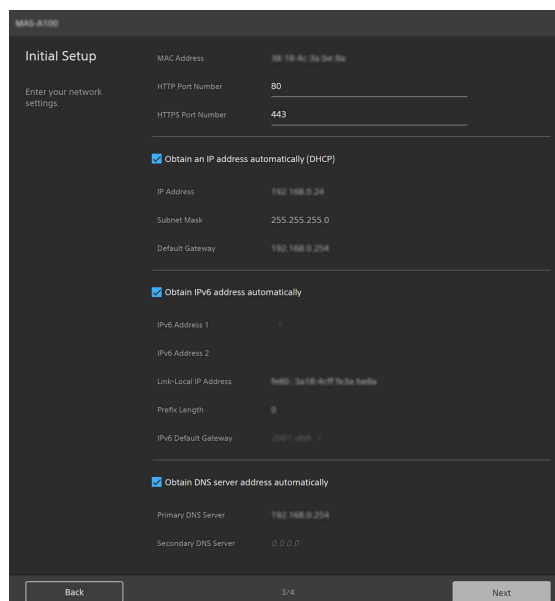

[MAC Address]: Displays the MAC address of the unit.

[HTTP Port Number]: Displays the port number for HTTP.

[HTTPS Port Number]: Displays the port number for HTTPS.

Note

The China model does not support the SSL function.

To obtain an IP address (IPv4) automatically from a DHCP server

Place a check mark in [Obtain an IP address automatically (DHCP)] to automatically acquire the IP address, subnet mask, and default gateway.

[IP Address]: Displays the current IP address.

[Subnet Mask]: Displays the current subnet mask value.

[Default Gateway]: Displays the current default gateway.

Note

If you select [Obtain an IP address automatically (DHCP)], check that a DHCP server is operating on the network.

To specify a fixed IP address (IPv4)

Clear the [Obtain an IP address automatically (DHCP)] checkbox and enter the following items.

[IP Address]: Enter the IP address of the unit.

[Subnet Mask]: Enter the subnet mask value.

[Default Gateway]: Enter the default gateway.

To obtain an IP address (IPv6) automatically

Place a check mark in [Obtain IPv6 address automatically] to automatically acquire the IP address, prefix length, and default gateway.

[IPv6 Address 1] / [IPv6 Address 2]: Displays the current IPv6 addresses.

[Link-Local IP Address]: Displays the current IPv6 link-local IP address.

[Prefix Length]: Displays the current prefix length.

[IPv6 Default Gateway]: Displays the current IPv6 default gateway.

Notes

- If you select [Obtain IPv6 address automatically], check with the network administrator whether IPv6 assignment is supported.
- Operation in a multi-prefix environment is not supported, and communication may not operate correctly.

To specify a fixed IP address (IPv6)

Clear the [Obtain IPv6 address automatically] checkbox and enter the following items.

[IPv6 Address 1]: Enter the IP address of the unit.

[Prefix Length]: Enter the prefix length.

[IPv6 Default Gateway]: Enter the default gateway.

To obtain the DNS server address automatically

Place a check mark in [Obtain DNS server address automatically] to automatically acquire the addresses of the primary DNS server and secondary DNS server.

[Primary DNS Server]: Displays the current primary DNS server IP address.

[Secondary DNS Server]: Displays the current secondary DNS server IP address.

Note

To obtain the DNS server address automatically, either [Obtain an IP address automatically (DHCP)] or [Obtain IPv6 address automatically] must be enabled. Check with the network administrator whether the environment supports a server address being obtained automatically.

To specify the DNS server address manually

Clear the [Obtain DNS server address automatically] checkbox and enter the following items.

[Primary DNS Server]: Enter the IP address of the primary DNS server.

[Secondary DNS Server]: Enter the IP address of the secondary DNS server.

8 When finished, click the [Next] button.

9 Set the date and time.

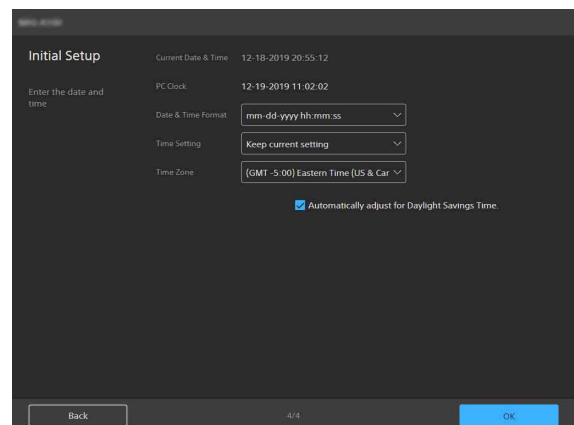

[Current Date & Time]

Displays the set date and time of the unit.

Note

The date and time set at the time of purchase may not be accurate. Always check the setting.

[PC Clock]

Displays the date and time of the computer being used.

[Date & Time Format]

Select the date and time format to display. You can select [yyyy-mm-dd hh:mm:ss], [mm-dd-yyyy hh:mm:ss], or [dd-mm-yyyy hh:mm:ss].

[Time Setting]

Select the method for setting the date and time.

[Keep current setting]: Select to keep the current settings for the date and time of the unit.

[Synchronize with PC]: Select to synchronize the date and time of the unit with the date and time of the computer.

[Manual Setting]: Select to set the date and time of the unit manually. Specify a value in the [Current Date & Time] field.

[Synchronize with NTP]: Select to synchronize the date and time of the unit with the NTP (Network Time Protocol) server of a time server. If you select [Synchronize with NTP], specify the NTP server.

[NTP Server]

Synchronize using the entered NTP server address.

[Time Zone]

Set the time zone for the region in which the unit is installed relative to Greenwich Mean Time.

Note

If the time zone selected in [Time Zone] and the time zone of the computer are different, a date and time reflecting the difference in time zones is set on the unit.

To adjust for Daylight Savings Time automatically

Place a check mark in [Automatically adjust for Daylight Savings Time.] to automatically adjust the time for daylight savings time (summer time) in the selected time zone.

10 When finished, click the [OK] button. The initial setup is completed.

When finished, the following screen appears.

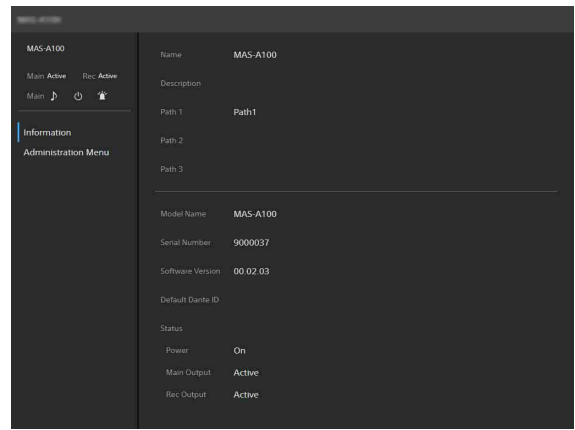

The status of the unit is displayed on the [Information] page. For details about the [Information] page, see “[Information] Page” (page 15).

11 Click [Administration Menu] to configure the device settings of the unit.

Tip

An authentication dialog will appear when the unit is currently accessed by a user other than the administrator.

Enter the administrator user name and password in the authentication dialog, and click the [OK] button to access the unit as the administrator.

The device settings screen of the unit appears.

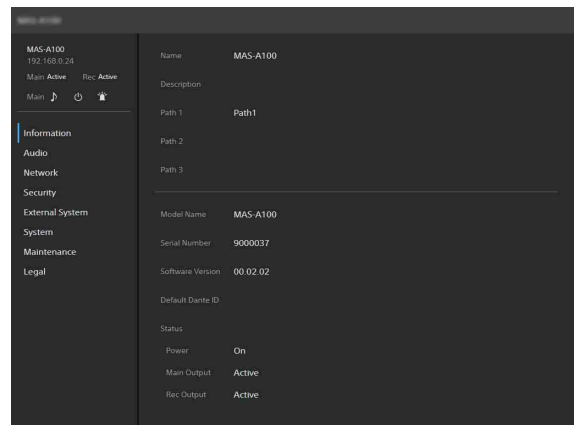

For details about device settings, see “Configuration (Device Settings)” (page 14).

Configuration (Device Settings)

This section describes the device settings on each menu page of the unit. This configuration is performed by the administrator.

Screen Structure

You can configure and control the unit from this screen.

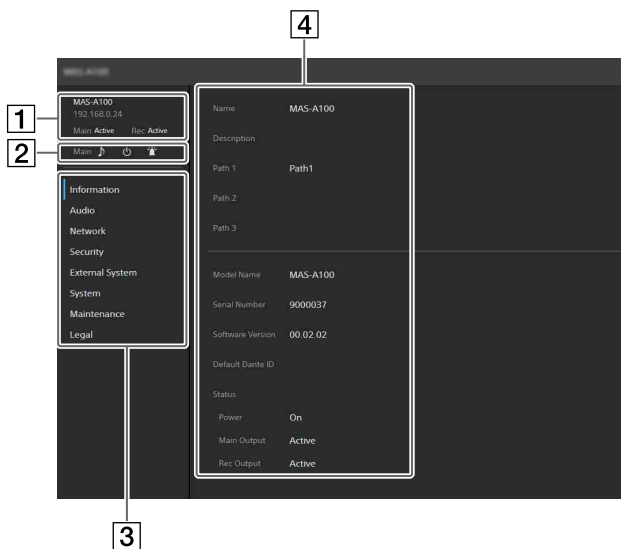

1 Status display Display when the unit is in active state

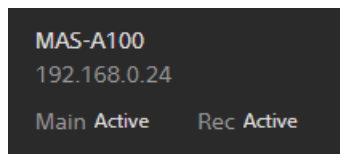

Line 1: Displays the name of the unit.

Line 2: Displays the IP address of the unit.
Not displayed when the unit is accessed by a general user.

Line 3: Displays the status of the Main output and Rec output. The Main output display changes to "Muted" state when the Main output is muted. The Rec output always displays "Active" state.

Display when the unit is in standby state

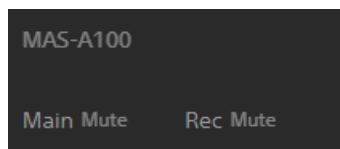

Line 1: Displays the name of the unit.

Line 2: Displays the IP address of the unit.
Not displayed when the unit is accessed by a general user.

Line 3: Displays the status of the Main output and Rec output. "Mute" is displayed in both places when in standby state.

2 Control icons



Switches the status of the Main output between normal state and muted state. Click the icon to switch the status of the unit. The status display of the unit also changes. The status can be controlled when the unit is in active state.

- When Main output is in normal state

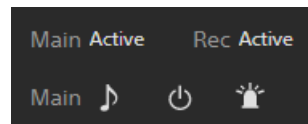

- When Main output is in muted state

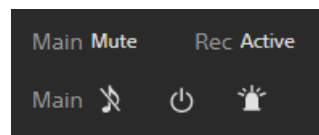

Switches the unit between active state and standby state. Click the icon to switch the status of the unit. The status display of the unit also changes.

- When the unit is in active state

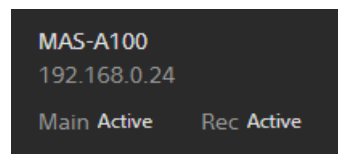

- When the unit is in standby state

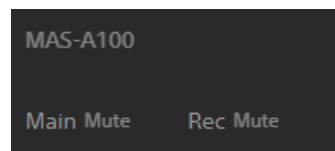

Click to start the LED on the unit flashing. This is useful if multiple units are installed, so that you can see which unit is being configured.

3 Device settings menu

Click to configure device settings common to the unit, such as audio and network settings.

4 Operation/settings area

Displays the setup screen for the selected device configuration menu item.

Basic Operations in the Device Settings Menu

Click an item in the device settings menu on the left side of the screen to display the setup screen for that item.

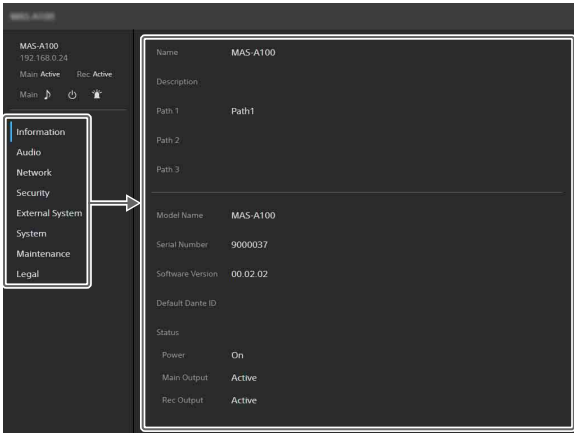

If the setup screen displays multiple tabs, click on a tab to switch the display in the setup screen.

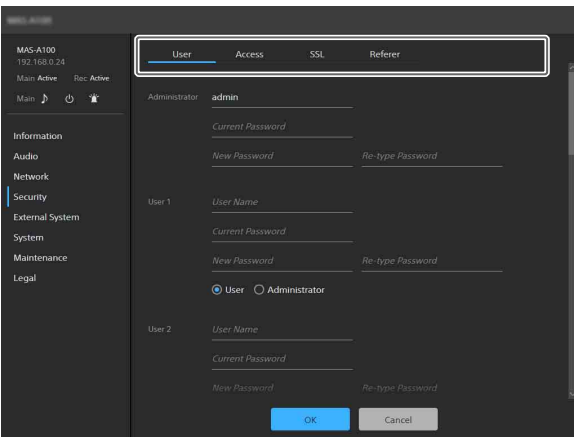

The following buttons at the bottom of the setup screen are common for all items.



[OK]: Click to apply the settings. The settings are not applied on the unit until you click this button.

[Cancel]: Click to discard the settings and return to the previous state.

Note

Only those items that are currently configurable are displayed. Items that are grayed out cannot be configured.

[Information] Page

Displays basic information and the status of the unit.

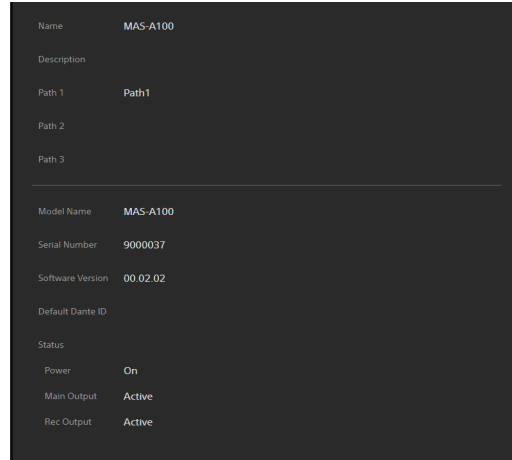

[Name]: Displays the name of the unit.

[Description]: Displays a description specified by the user of the unit.

[Path 1] to [Path 3]: Displays character strings specified by the user (such as name of building, floor number, room name).

[Model Name]: Displays the model name.

[Serial Number]: Displays the serial number.

[Software Version]: Displays the software version.

[Default Dante ID]: Displays the default Dante ID.

The items above reflect the settings of the [Device info] tab of the [System] page.

[Status]: Displays the status of the power source, Main output, and Rec output of the unit.

[Audio] Page

Use to configure the audio of the unit.

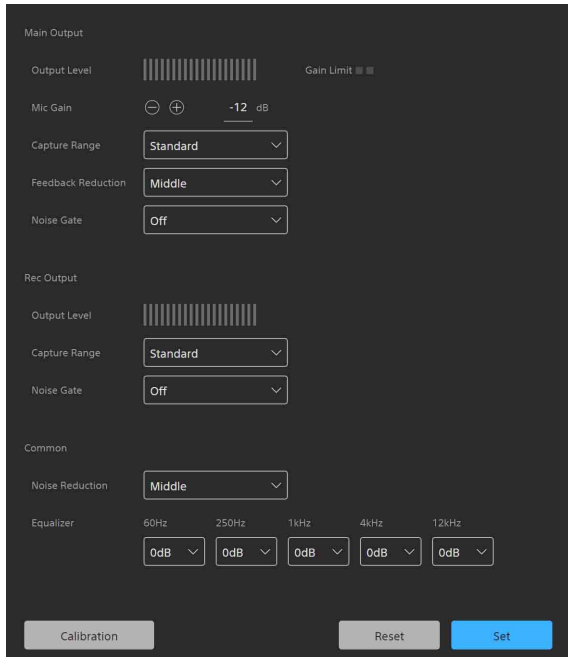

Audio Settings

[Main Output]

Configures output settings for components of the speech reinforcement system, such as an audio mixer or loudspeaker.

[Output Level]: Displays the output level of the unit on a level meter. The volume is louder when the bar is longer.

[Gain Limit]: Lights up when the microphone gain exceeds the range where audio quality can be maintained.

[Mic Gain]: Sets the microphone gain. Click the +/- buttons or enter a value directly to set the gain in the range -60 dB to +12 dB in 1 dB increments.

[Capture Range]: Sets the microphone capture range. Can be set to [Narrow], [Standard], or [Wide].

[Feedback Reduction]: Sets the feedback reduction level. Can be set to [High], [Middle], or [Low]. When [High] is selected, the feedback reduction effect increases, but with corresponding increased change in audio quality.

[Noise Gate]: Attenuates the audio when the input level is low. The threshold level can be set to [OFF], [High], [Middle], or [Low]. When this function is enabled, noise and other low input audio is attenuated. Note that detection of actual audio input takes a finite time, so the start of a conversation may be cut.

[Rec Output]

Configures the output settings for recording.

[Output Level]: Same as for [Main Output].

[Capture Range]: Same as for [Main Output].

[Noise Gate]: Same as for [Main Output].

[Common]

These settings are applied to both [Main Output] and [Rec Output].

[Noise Reduction]: Reduces the noise from the surrounding environment. The reduction level can be set to [High], [Middle], or [Low]. When set to [High], the noise reduction is stronger, but it may adversely affect the audio quality.

[Equalizer]: Adjusts the gain for the [60Hz], [250Hz], [1kHz], [4kHz], and [12kHz] frequency bands. Set the gain in the range -12 dB to +12 dB in 1 dB increments.

To save the settings

Click the [Set] button.

Clicking the [Reset] button discards the changes to settings and returns to the previous settings.

Note

The [Reset] button cannot be used to reset to the factory default settings. To reset to the factory default settings, initialize the unit (page 24).

Calibration

Calibration optimizes the output of the unit.

The unit must be calibrated whenever the usage environment of the unit changes.

Tip

Only [Main Output] is calibrated.

1 Click the [Calibration] button at the bottom left of the screen.

The [Calibration of Main output] screen appears.

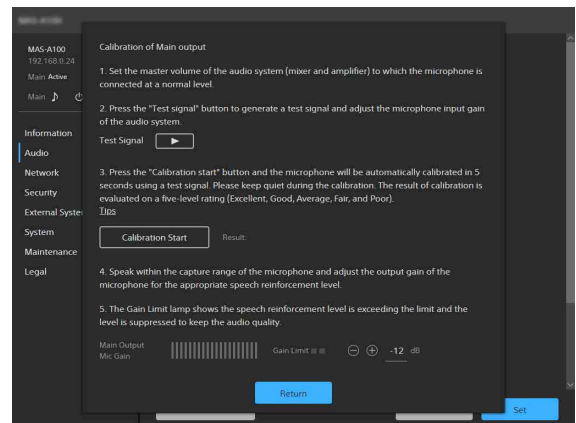

2 Follow the on-screen instructions to perform calibration.

Tip

Clicking [Tips] displays tips on a separate screen. The [Tips] screen describes the calibration result score, and offers tips on how to achieve a higher score. Click anywhere on the [Tips] screen to close the screen.

3 When calibration is completed, click the [Return] button.

[Network] Page

Use to configure the network settings for connection between the unit and a computer.

The screenshot shows the [Network] configuration page with the following settings:

- MAC Address: 38:18:4c:3a:5e:8a
- HTTP Port Number: 80
- HTTPS Port Number: 443
- Obtain an IP address automatically (DHCP)
- IP Address: 192.168.0.24
- Subnet Mask: 255.255.255.0
- Default Gateway: 192.168.0.254
- Obtain IPv6 address automatically
- IPv6 Address 1: -
- IPv6 Address 2: -
- Link-Local IP Address: fe80::3a18:4c3f:8c3a:5e8a
- Prefix Length: 64
- IPv6 Default Gateway: 2001::1
- Obtain DNS server address automatically
- Primary DNS Server: 192.168.0.254
- Secondary DNS Server: 0.0.0.0

At the bottom, there are two buttons: "OK" (highlighted in blue) and "Cancel".

For a description of the settings, see step 7 in "Configuring Initial Setup Items" (page 11).

[Security] Page

Use to configure settings relating to security on the unit.
The screen consists of [User], [Access], [SSL], and [Referer] tabs.

[User] tab

Use to configure users.
You can configure the user name, password, and user access permissions of one administrator and nine general users.

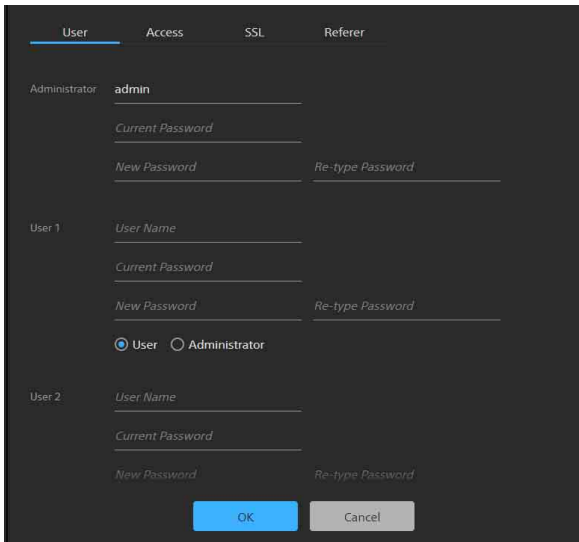

Administrator and general users

Users on the unit are categorized into administrator and general users.
An administrator can access all settings and operate the unit. A general can access some settings and operate the unit.

[Administrator], [User 1] to [User 9]

Set the following items for the administrator and each general user.

[User Name]: Enter a user name comprising 5 to 16 characters.

[Current Password]: Enter the currently configured password comprising 8 to 64 characters.

[New Password]: Enter the new password you want to set comprising 8 to 64 characters.

[Re-type Password]: Re-enter the new password you want to set to verify the password.

Administrator permission selection: To grant administrator access to a user, select [Administrator]. To set a general user without administrator access, select [User].

Notes

- The following characters are valid in user names and passwords. Include at least one upper-case letter, one lower-case letter, and one number in passwords.
 - Alphanumeric characters
 - Symbols (!\$%')=--^|@`[{}]/?<>+*.)
- A user name and new password must be configured when adding a user.
- To change the user information, all items must be specified again.
- When deleting a user, leave all fields other than [Current Password] blank.

[Access] tab

Use to configure the security function to restrict the computers that can access the unit.
Similarly, you can also configure security for each network when using IPv6.

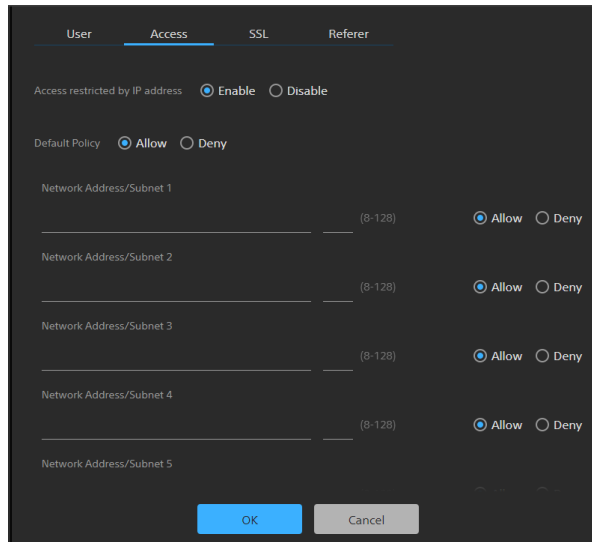

To enable IP address restrictions

Select [Enable] for [Access restricted by IP address], and configure the following items.

[Default Policy]

Select [Allow] or [Deny] to allow or deny access from computers whose network address is outside the ranges configured in [Network Address/Subnet 1] to [Network Address/Subnet 10].

[Network Address/Subnet 1] to [Network Address/Subnet 10]

Enter the network address/subnet mask value that you want to allow or deny access. You can specify up to ten network addresses and subnet mask values.

Enter a subnet mask value of 8 to 32 (8 to 128 for IPv6).

Set access to [Allow] or [Deny] individually for each network address/subnet mask.

Tips

- The subnet mask value indicates the number of bits that are masked off from the left. For example, the subnet mask value for 255.255.255.0 is 24. If you set "192.168.0.0/24" and [Allow], computers having an IP address between 192.168.0.0 and 192.168.0.255 have access allowed.
- You can access the unit even from a computer with an IP address whose access right is set to [Deny], if you enter the user name and password set for the Administrator using the [User] tab of the [Security] page on the authentication screen.

[SSL] tab

Use to configure the SSL or TLS function (hereinafter referred to as SSL). Configuring these settings allows the unit to use SSL communication with client devices.

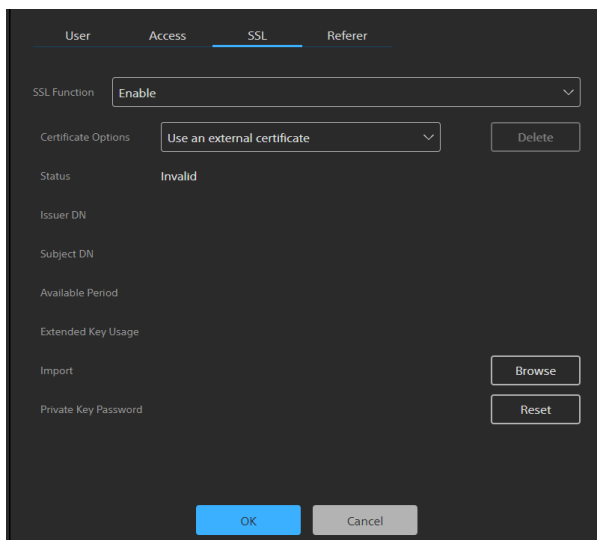

Notes

- The China model does not support the SSL function.
- When using the SSL function, always configure the settings after setting the date and time of the unit. If the date and time are not set correctly, it may not be possible to connect to the unit using a web browser.
- Reload the web browser after you change the SSL settings.
- "TLS1.2" encryption is employed for high-security communication.

To enable the SSL function

Select [Enable] from the [SSL Function] pull-down menu to enable the SSL function. When [Enable (Allow HTTP connection for some clients)] is selected, both SSL connections and HTTP connections are allowed.

When [Enable] is selected, only SSL connections are allowed.

Precautions with SSL connections

When you use only SSL connections with the SSL function set to [Enable], you will not be able to access the unit if the SSL function is not working properly.

In this case, you must reset the unit to the factory settings. (All settings will be initialized.)

To avoid this, check that SSL connection can be established before configuration by performing the following steps.

- 1 Set the SSL function to [Enable (Allow HTTP connection for some clients)].

Note

Always select [Enable (Allow HTTP connection for some clients)]. If it is not selected and the SSL connection fails, you will not be able to access the unit.

- 2 Click the [OK] button to close the web browser.

- 3 Display the web browser using an SSL connection.

- 4 After confirming that SSL connection is possible, set the SSL function to [Enable].

Tip

If the SSL connection fails while checking the connection, you can select [Enable (Allow HTTP connection for some clients)] to connect using an HTTP connection. Check the settings on the [SSL] tab using an HTTP connection, and then check the SSL connection again.

[Certificate Options]

Select the certificate installation mode.

[Use an external certificate]: This mode uses a certificate (including private key information) issued by a CA. PKCS#12 and PEM certificate formats are supported.

[Use a self-signed certificate (For test use)]:

This mode uses a certificate and private key pair generated as described in "To generate a self-signed certificate" (page 20). The private key information corresponding to the certificate is stored within the unit.

You do not need to install an external certificate, but validating its existence, which is one of the SSL functions, is not possible for the following reasons.

- Self-signing uses the private key generated in the unit.
- A preconfigured value is set for the Distinguished Name (Common Name, and so on).

- The certificate is not issued by a CA trusted by the customer's system.

For reasons of security, we recommend using this certificate only when there is no problem and a lack of total security is not a concern, such as for testing.

Notes

- When [Use a self-signed certificate (For test use)] is selected, a security alert appears when initiating an SSL connection with a web browser.
- SSL connection may not be possible depending on the type of certificate installed in the unit.

To import a certificate

Click the [Browse] button at the bottom right of the setup screen and select the certificate. Click the [OK] button in the file selection dialog to import the selected file into the unit.

Notes

- The import process is invalid if the selected file is not a certificate or if the format of the imported certificate is not allowed.
- In software version 2.00 and later, the following insecure certificates are disabled.
 - Certificates with a private key of 1024 bits or smaller
 - Certificates that use a weak algorithm, such as MD5/SHA1

To generate a self-signed certificate

A self-signed certificate must be generated when [Use a self-signed certificate (For test use)] is selected in [Certificate Options].

Click the [Generate] button to generate a self-signed certificate in the unit.

Clicking the [Generate] button again after generating a self-signed certificate will update the self-signed certificate stored in the unit.

Notes

- Make sure to set the date and time on the unit before performing this operation. If the date and time are not set correctly, it may not be possible to connect to the unit using a web browser.
- Before clicking the [Generate] button to generate a self-signed certificate, select [Use a self-signed certificate (For test use)] in [Certificate Options] and click the [OK] button.

To display the certificate contents

When the certificate has been configured in the unit correctly, information from the certificate appears in [Status], [Issuer DN], [Subject DN], [Available Period], and [Extended Key Usage].

[Status]

Displays whether the status of the certificate is valid or invalid. The following status types are displayed.

[Valid]: The certificate is correctly stored and configured.

[Invalid]: The certificate is not correctly stored and configured. If invalid, possible causes are as follows:

- [Use an external certificate] is selected but the private key password included in the certificate is not specified correctly.
- [Use an external certificate] is selected but the private key included in the certificate is not encrypted. Or the private key password is specified but is not encrypted.
- [Use an external certificate] is selected but the required private key is not included in the certificate.
- [Use a self-signed certificate (For test use)] is selected but a self-signed certificate has not been generated.

Note

When the certificate to be imported is in PKCS#12 format and the private key password is not specified correctly, "<Put correct private key password>" is displayed in the [Issuer DN], [Subject DN], [Available Period], and [Extended Key Usage] fields. Specify the correct private key password.

To delete the imported certificate or self-signed certificate

Click the [Delete] button on the setup screen to delete the imported certificate or self-signed certificate.

To specify the private key password

Enter a password comprising up to 50 characters for the private key included in the certificate in [Private Key Password]. Entry is supported only when [Certificate Options] is set to [Use an external certificate].

Leave the field for this parameter blank if the private key included in the certificate is not encrypted.

To enter the private key password, click the [Reset] button and enter a password.

Note

Click the [Cancel] button at the bottom of the screen if you want to cancel changing the private key password after clicking the [Reset] button. Note that clicking the [Cancel] button also restores all other setting items on the [SSL] tab to the previous settings.

[Referer] tab

Use the [Referer] tab to configure the Referer check function. "Referer Check" is a function that checks whether the web page which requested the access is legitimate when the unit is accessed from an external source. If the web page cannot be confirmed as legitimate, access is denied.

If you want to access the unit from a web page other than one that the unit provides, register the host name and port number that hosts the web page on this tab.

No.	Host Name	Port No.	Reset
No. 1	Host Name	Port No.	Reset
No. 2	Host Name	Port No.	Reset
No. 3	Host Name	Port No.	Reset
No. 4	Host Name	Port No.	Reset
No. 5	Host Name	Port No.	Reset
No. 6	Host Name	Port No.	Reset
No. 7	Host Name	Port No.	Reset
No. 8	Host Name	Port No.	Reset
No. 9	Host Name	Port No.	Reset
No. 10	Host Name	Port No.	Reset

To enable Referer check

Select [Enable] in [Referer Check]. The following [Exception List] items can be configured when Referer check is enabled.

[No. 1] to [No. 10]: Register hosts that are not subjected to the Referer check as an exception list.

[Host Name]: Enter the host name or IP address of the computer that hosts the web page you want to register in the exception list.

[Port No.]: Enter the port number of the computer that hosts the web page you want to register in the exception list.

[Reset]: Reset the exceptions settings.

[External System] Page

You can set whether to allow or disable control of this unit by other models on the same network as the unit.

Note

Only enable this function if the unit is connected to a secure network.

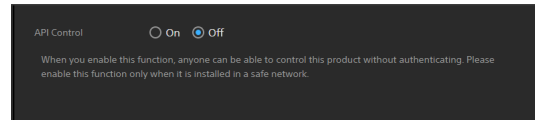

[On]: Allow control of this unit by other models.

[Off]: Disable control of this unit by other models.

[System] Page

Use to configure the basic system settings of the unit.

The screen consists of [Device info], [Option], and [Date & Time] tabs.

[Device info] tab

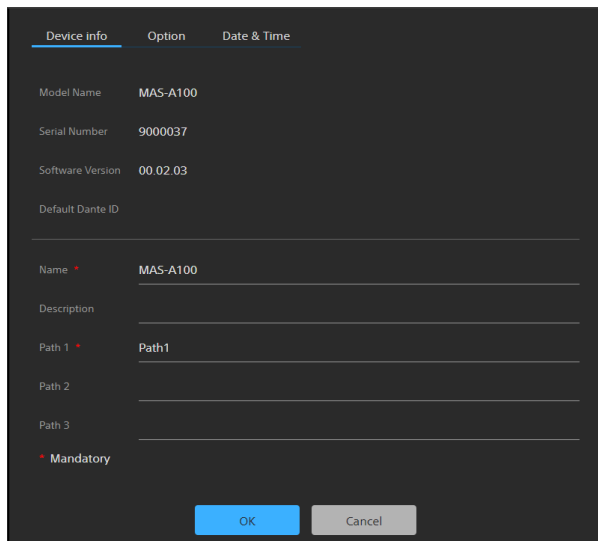

[Model Name]

Displays the model name of the unit.

[Serial Number]

Displays the serial number of the unit.

[Software Version]

Displays the software version of the unit.

[Default Dante ID]

Displays the default Dante ID.

[Name]

Enter the name of the unit. Entry is mandatory.

[Description]

Enter a description specified by the user of the unit.

[Path 1] to [Path 3]

Enter character strings specified by the user (such as name of building, floor number, room name). [Path 1] entry is mandatory.

[Option] tab

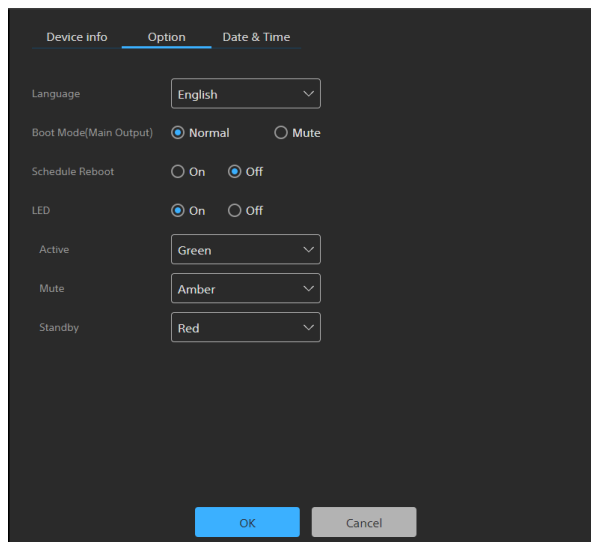

[Language]

Specify the display language of the screen. You can select [English], [Japanese], [German], [French], [Spanish], or [Chinese].

After selecting a language, click the [OK] button to change the display to the selected language.

[Boot Mode(Main Output)]

Specify the audio output status after booting.

[Normal]: Boot into state with normal audio output.

[Mute]: Boot into state with audio muted.

[Schedule Reboot]

Set whether to reboot the unit at a specified time. When set to [On], select the time schedule for rebooting.

Available settings: 0:00 to 23:00 in 1-hour increments

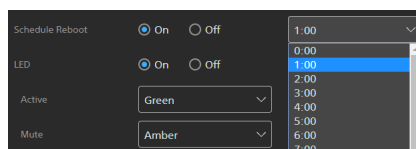

[LED]

Specify whether the LED is lit.

When set to [On], the emitted color can be set to green, amber, or red to indicate the status of the unit.

[Active]: Select the color of the LED when the unit is in active state.

[Mute]: Select the color of the LED when the unit is muted.

[Standby]: Select the color of the LED when the unit is in standby state.

[Date & Time] tab

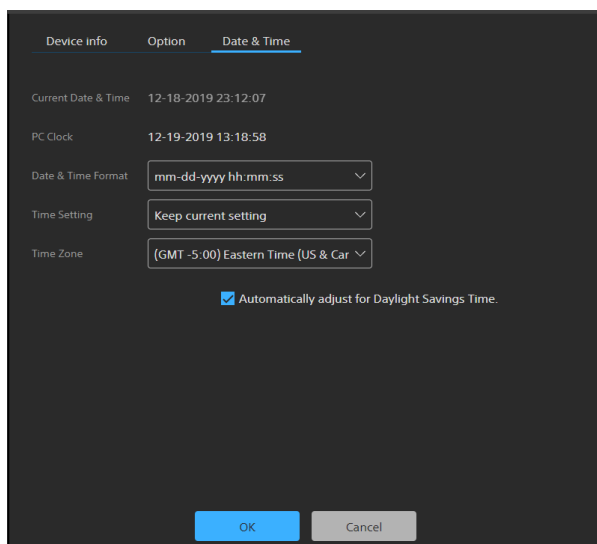

[Current Date & Time]

Displays the set date and time of the unit.

Note

The date and time set at the time of purchase may not be accurate. Always check the setting.

[PC Clock]

Displays the date and time of the computer being used.

[Date & Time Format]

Select the date and time format to display. You can select [yyyy-mm-dd hh:mm:ss], [mm-dd-yyyy hh:mm:ss], or [dd-mm-yyyy hh:mm:ss].

[Time Setting]

Select the method for setting the date and time.

[Keep current setting]: Select to keep the current settings for the date and time of the unit.

[Synchronize with PC]: Select to synchronize the date and time of the unit with the date and time of the computer.

[Manual Setting]: Select to set the date and time of the unit manually. Specify a value in the [Current Date & Time] field.

[Synchronize with NTP]: Select to synchronize the date and time of the unit with the NTP (Network Time Protocol) server of a time server. If you select [Synchronize with NTP], specify the NTP server.

[NTP Server]

Synchronize using the entered NTP server address.

[Time Zone]

Set the time zone for the region in which the unit is installed relative to Greenwich Mean Time.

Note

If the time zone selected in [Time Zone] and the time zone of the computer are different, a date and time reflecting the difference in time zones is set on the unit.

To adjust for Daylight Savings Time automatically

Place a check mark in [Automatically adjust for Daylight Savings Time.] to automatically adjust the time for daylight savings time (summer time) in the selected time zone.

[Maintenance] Page

Use for maintenance of the unit.
The screen consists of [Restart/Log] and [Update] tabs.

[Restart/Log] tab

Tip

When restarting or initializing the unit due to some form of problem, it is recommended to download the operation log and service log before restarting or initializing in order to resolve the cause of the problem.

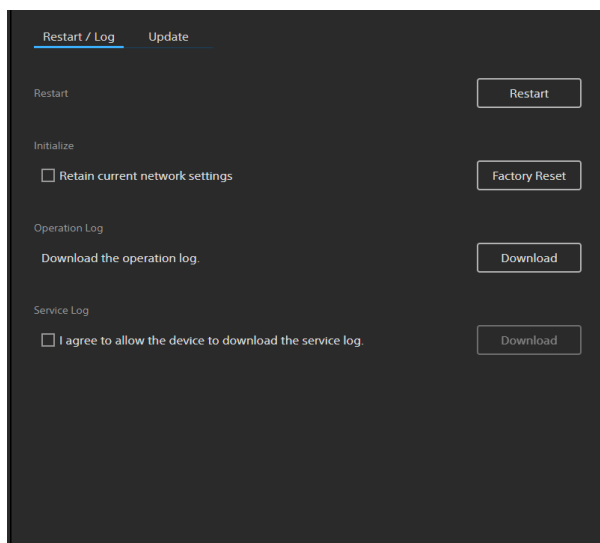

[Restart]

Click the [Restart] button when you want to restart the unit. Click the [OK] button in the displayed confirmation dialog to restart the unit.

[Initialize]

Use this when you want to reset the unit to the factory default settings. Click the [Factory Reset] button, and click the [OK] button in the displayed confirmation dialog to reset the settings to the factory default settings and restart the unit. You can reset the unit to its factory default settings using the reset switch on the unit (page 5).

To retain network settings

Place a check mark in [Retain current network settings] to retain only the current network settings when resetting the unit to the factory default settings. The corresponding items are configured on the [Network] and [Security] pages.

Note

To protect customer information, reset the settings of this unit to the factory settings when

lending or transferring the unit to another person and when disposing of the unit.

[Operation Log]

Click the [Download] button to download the operation log containing the usage and status information recorded on the unit.

[Service Log]

Place a check mark in [I agree to allow the device to download the service log.] and click the [Download] button to download system diagnostics used for system maintenance.

[Update] tab

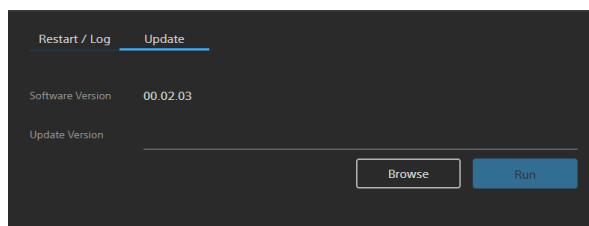

Use this to check and update the software version of the unit.

To update the software

Click the [Browse] button, select the firmware update file, and click the [Run] button. The unit restarts automatically, and the update is executed.

[Legal] Page

This page displays the EULA and software information for the unit.
The screen consists of [EULA] and [Software] tabs.

[EULA] tab

Displays the EULA (End User License Agreement).

[Software] tab

Displays the software licenses used by the unit.

Operation

This section describes the operation of the unit after configuration is completed.

1 Access the unit from a web browser.

For details about accessing the unit, see “Accessing the Unit from a Web Browser” (page 10).

The following screen appears.

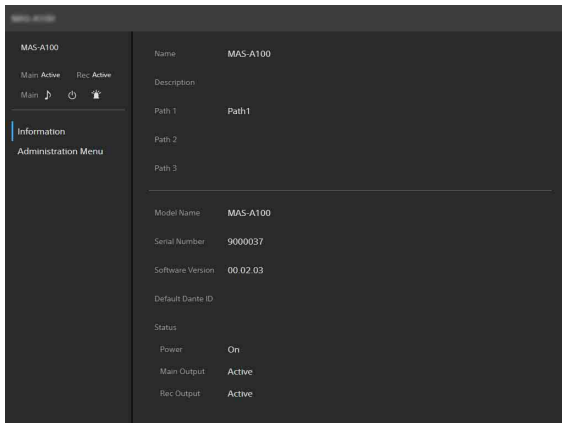

If the unit is accessed as an administrator, click [Administration Menu] to display the setup screen for the device configuration menu.

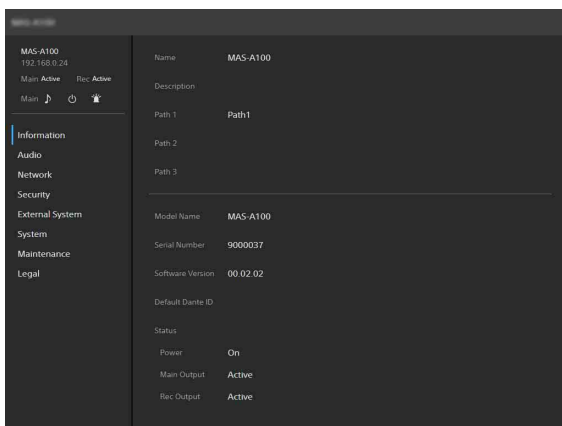

Tip

If the unit is accessed as a general user, clicking [Administration Menu] will display the authentication dialog. Enter the administrator user name and password, and click the [OK] button to display the device configuration menu.

2 Check the status of the unit before operation.

For details, see “**1** Status display” (page 14) and “**2** Control icons” (page 14) in the “Screen Structure” section.

Usage Precautions

Notes

- Always verify that the unit is operating properly before use. SONY WILL NOT BE LIABLE FOR DAMAGES OF ANY KIND INCLUDING, BUT NOT LIMITED TO, COMPENSATION OR REIMBURSEMENT ON ACCOUNT OF THE LOSS OF PRESENT OR PROSPECTIVE PROFITS DUE TO FAILURE OF THIS UNIT, EITHER DURING THE WARRANTY PERIOD OR AFTER EXPIRATION OF THE WARRANTY, OR FOR ANY OTHER REASON WHATSOEVER.
- SONY WILL NOT BE LIABLE FOR CLAIMS OF ANY KIND MADE BY USERS OF THIS UNIT OR MADE BY THIRD PARTIES.
- SONY WILL NOT BE LIABLE FOR THE TERMINATION OR DISCONTINUATION OF ANY SERVICES RELATED TO THIS UNIT THAT MAY RESULT DUE TO CIRCUMSTANCES OF ANY KIND.

Use and storage locations

Avoid using or storing the unit in the following places.

- In excessive heat or cold
- In direct sunlight or close to heaters for extended periods
- Near strong magnetic fields
- Close to radio or TV transmitters producing strong electromagnetic fields
- Locations subject to vibration or impact

Condensation

If the unit is suddenly taken from a cold to a warm location, or if ambient temperature suddenly rises, moisture may form on the outer surface of the unit and/or inside of the unit. This is known as condensation. If condensation occurs, turn off the unit and wait until the condensation clears before operating the unit. Operating the unit while condensation is present may damage the unit.

Network security

- SONY WILL NOT BE LIABLE FOR DAMAGES OF ANY KIND RESULTING FROM A FAILURE TO IMPLEMENT PROPER SECURITY MEASURES ON TRANSMISSION DEVICES, UNAVOIDABLE DATA LEAKS RESULTING FROM TRANSMISSION SPECIFICATIONS, OR SECURITY PROBLEMS OF ANY KIND.

- Depending on the operating environment, unauthorized third parties on the network may be able to access the unit. When connecting the unit to the network, be sure to confirm that the network is protected securely. Use the SSL function, Referer check function, or other security measures to prevent unauthorized access to the unit. For details about functions, see “[Security] Page” (page 18).
- From a safety standpoint, when using the unit connected with the network, it is strongly recommended to access the Control window via a Web browser and change the access limitation settings from the factory preset values. Changing the password regularly is also recommended. For details about changing the password, see “[Security] Page” (page 18).
- Do not browse any other website in the Web browser while making settings or after making settings. Since the login status remains in the Web browser, close the Web browser when you complete the settings to prevent unauthorized third parties from using the unit or harmful programs from running.

Notes

- The China model does not support the SSL function.
- To protect customer information, reset the settings of this unit to the factory settings when lending or transferring the unit to another person and when disposing of the unit.

Indicator/Message List

Perform the following actions, according to the indicator/message of the unit.

LED indicators

LED	Meaning and solution
LED is not lit	<ul style="list-style-type: none">• Power is not being supplied to the unit. Check the PoE LAN cable connection and the PoE network switch status.• The LED may have been turned off on the [System] page. Set [System] > [Option] > [LED] to On.
LED is flashing alternately between green and red	Indicates a board error. Consult your Sony service representative.

Web browser display

Message	Meaning and solution
Do not use the default administrator password.	The default administrator password is for use only when accessing the unit for the first time. Change the administrator password as described in step 5 in "Configuring Initial Setup Items" (page 11).
Unstable Network Check your network connection.	Check the network connection of the unit.
Software Update Failed The software update has failed. Check the software version.	The software update may have failed. Check that the software update was completed successfully, and check the software version.
Check the software version.	The software update has finished. Check that the software update was completed successfully, and check the software version.

Troubleshooting

Before requesting service, check the following as a guide to troubleshooting the problem. Also refer to the troubleshooting information in the System Integration Guide. If the problem persists, consult your Sony service representative.

Symptom	Cause	Solution
The unit does not turn on.	The cable connecting to the PoE switching hub is not securely connected.	Insert the connection cable firmly as far as it will go.
	A switching hub that does not support PoE is being used.	Use a switching hub that supports PoE.
	A LAN cable that does not support PoE is being used.	Use a LAN cable that supports PoE.
	There is a problem with the PoE switching hub.	Connect according to the operating instructions of the PoE switching hub.
Audio is not output.	The initial setup has not been completed.	Complete the setup described in "Configuring Initial Setup Items" (page 11).
	The connected device is muted.	Cancel muting of the connected device.
	The connected device is not turned on.	Turn on the connected device.
	The Dante Controller settings are invalid.	Check the Dante Controller settings.
Dante Controller cannot detect the unit.	The network settings are incorrect.	Check the network settings.
The MASM-1 software cannot detect the unit.	The network settings are incorrect.	Check the network settings.
The problem persists after trying all solutions.	—	Disconnect the LAN cable, wait a short while, and then reconnect the cable.
	—	Press the reset switch to restore the factory settings.

About Use of GNU GPL/ LGPL Software

This product uses software to which the GNU General Public License (GPL) or GNU Lesser General Public License (LGPL) applies. This informs you that you have a right to have access to, modify, and redistribute source code for these software programs under the conditions of the GPL/LGPL.

The source code is provided on the internet. Use the following URL and follow the download instructions.

<http://oss.sony.net/Products/Linux>

We would prefer that you do not contact us about the contents of the source code.

Specifications

General

Power source	Supply from IEEE802.3af PoE Class 0 device
Power consumption	13 W (max.) 9 W (typ.)
Dimensions	See "Dimensions (main unit)" (page 31) and "Dimensions (ceiling bracket)" (page 32)
Mass	Approx. 1 kg (2 lb 3.3 oz) (main unit only) Approx. 1.3 kg (2 lb 14 oz) (with ceiling bracket)
Operating temperature	0 °C to 40 °C (32 °F to 104 °F)
Operating humidity	20% to 80% (non-condensing)
Storage temperature	-20 °C to +60 °C (-4 °F to 140 °F)
Storage humidity	20% to 80% (non-condensing)

Input/output connector

LAN (1)	Supports RJ-45 100/1000BASE-T Cat5e UTP or higher cable
---------	---

LED

STATUS lamp (1)	Green/Amber/Red
-----------------	-----------------

Supplied accessories

Ceiling bracket (1)
Template (1)
Safety Regulations (1)

Design and specifications are subject to change without notice.

Dimensions (main unit)

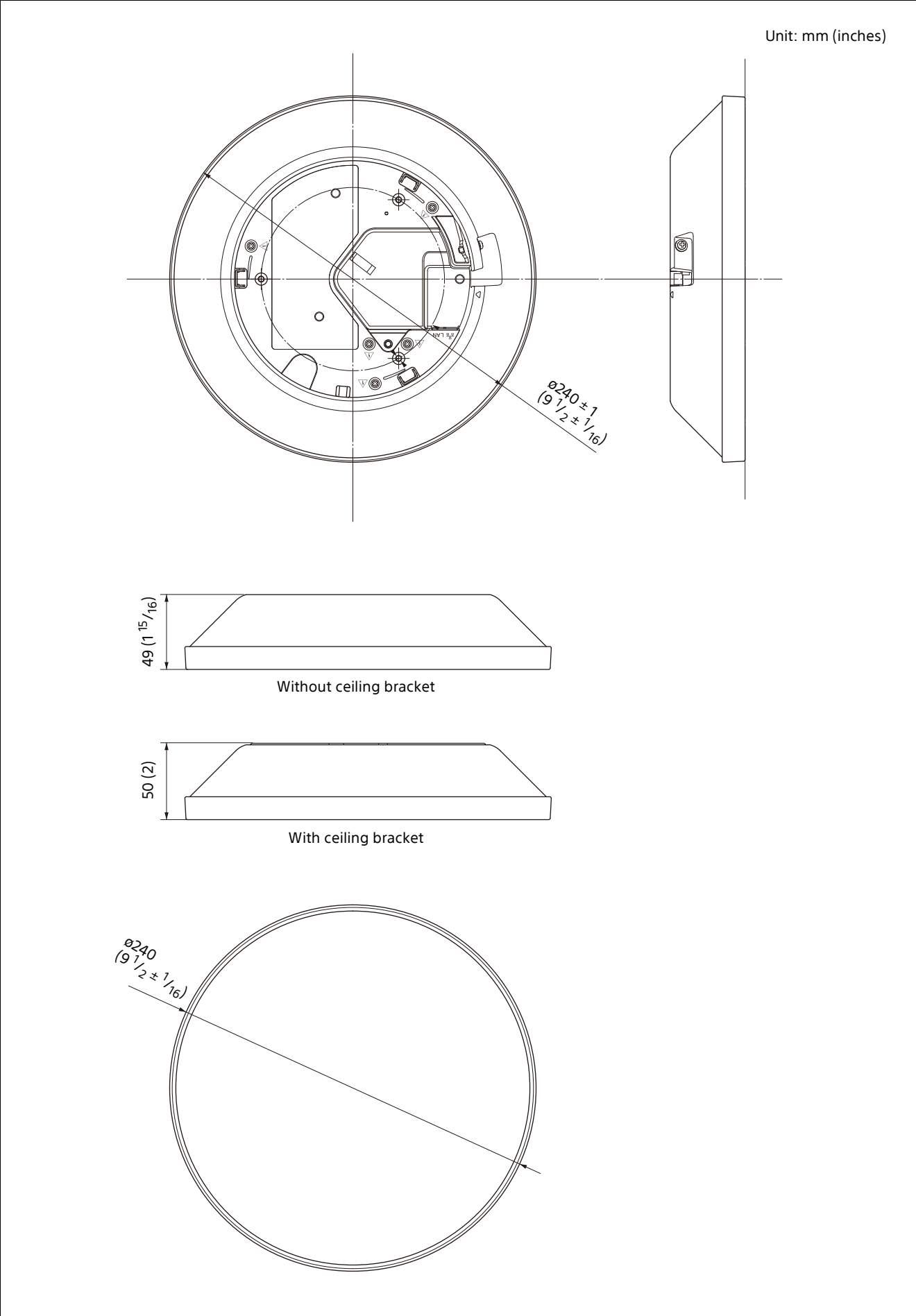

Dimensions (ceiling bracket)

Unit: mm (inches)

