

PROJECTION
SCREENS
GET THE BIG
PICTURE

le Screen[®]

BY MULTIBRACKETS

Le Screen[®]

BY MULTIBRACKETS

AT Le Screen we get the Big Picture. We know TVs are great, but if you want to make a really epic presentation or watch entertainment the way it was supposed to, you need a projection screen. One hundred plus inches of highdefinition awesomeness. The way to present and the way to watch is way more important than most people think. As they say - there is just one time to make a first impression, and we want that to be a great one, whether it is a company presentation or watching the game with your friends. Our series of projection screens are built to deliver and adds flexibility and real quality to your set up. Designed in Stockholm, Sweden to provide outstanding performance with a sleek and streamlined outlook, it gives your visitors the impression you want to leave behind. With one of the largest selections available our screen solutions are ideal for public, office and home use.



LE PROJECTION SCREENS

Manual	8 - 11
Motorized	14 - 21
Framed	24 - 29
Portable	32 - 35
Quick-Fold	38 - 41
Projector Ceiling Mounts	44 - 49



Mission

Le Screen's mission is to make High-end Quality Projection Screens available to every budget without compromising the product quality.

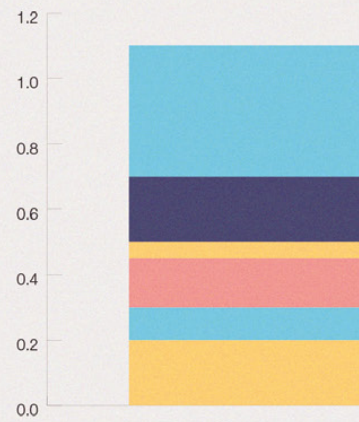



MANUAL PROJECTION SCREENS DELUXE

MANUAL PROJECTION SCREENS DELUXE

ELEGANT DESIGN & SUPERIOR MATERIAL CHOICES

Le Screen Manual Self-Lock Projection Screen Deluxe are elegant projection screens designed with a aluminum cassette, high-end for the living room, home theatre, conference rooms or for educational use in schools. With a sleek Nordic design this projection screen fits any environment it is installed in.

The Le Screen Projection Screens are easy to install and even easier to use. Just sit back and enjoy the show! Non compromised material choices is used when making a Le Screen Manual Screen giving you market leading technical specifications and optimized picture quality.

Slow retention

A slow retention function is built into the manual screens. This makes the screen retract slowly and controlled retract into the cassette. This prolong the lifetime (normally doubles the life expectancy) of the projection screen and makes the manual screen usable in more public environments where multiple users handle the screen every day.

Superior screen material

The quality of screen material is the most important aspect of any projection screen. Most screens on the market will use a very basic compressed cloth type material resulting in a creased surface and poor contrast performance. The Le Screen Projection Screen Deluxe series use a high quality multi ply material with a high contrast and low gain of 1.0. The material is tear resistant, fireproof, anti wrinkle

safe and is designed to hang flat. The centre layer is a glass fibre net producing a flex rate of less than 1% compared with the industry average of 33%. The front layer optimizes contrast and reflectivity while a black PVC backing prevents light leakage and helps retain a uniformly flat projection surface.

Elegant design

Le Screen Manual Self-Lock Projection Screens Deluxe are an elegant series of manual screens. The cassette is all aluminum coated in white paint. High quality details & superior design makes this piece a beauty among projection screens.

Formats

Available in 16:9, 16:10, 4:3 or 1:1. (16:9, 16:10, 4:3 are surrounded by a black boarder for contrast).

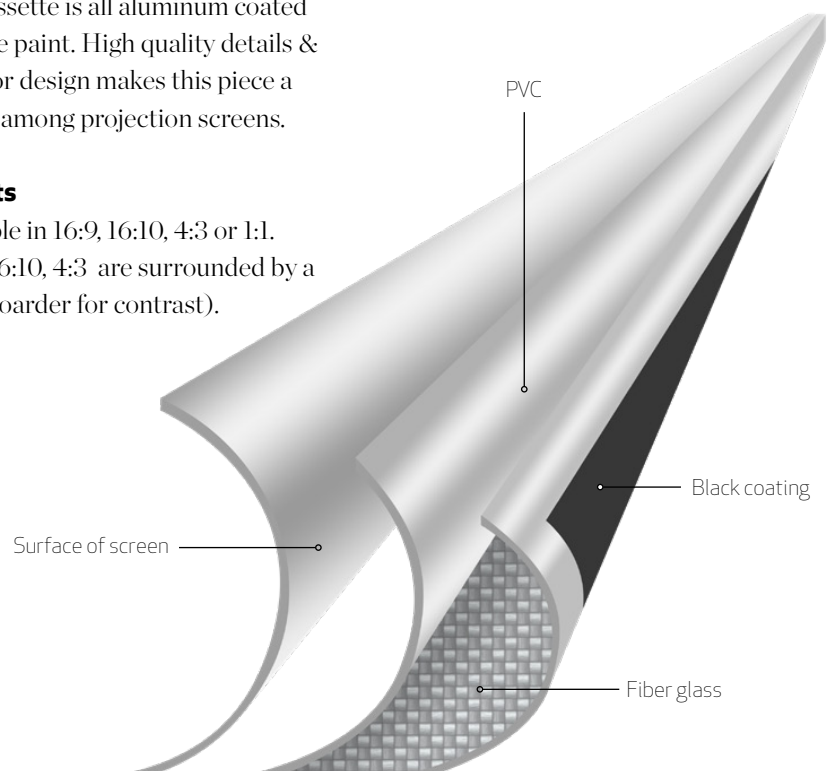

High Quality Aluminum Case
lightweight yet durable

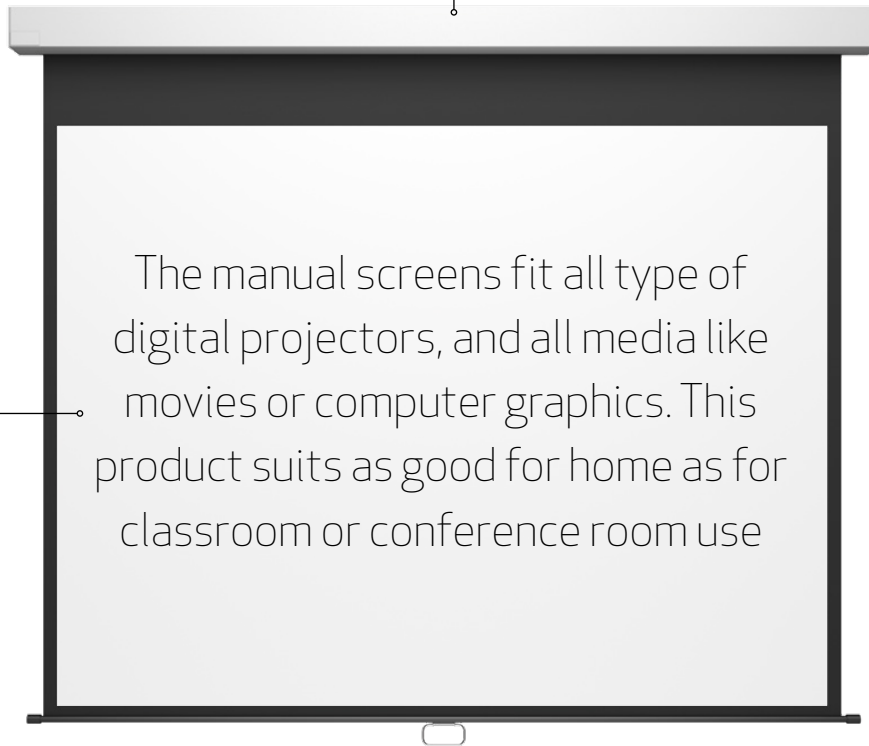

Cleanable Screen Material
for easy maintenance

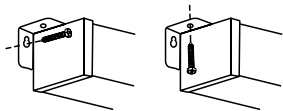

Wall/Ceiling mounting
For multiple placement options



Slow Retention Design
For smooth screen retraction

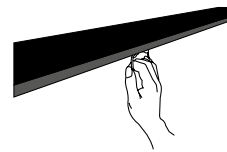

Durable Handle
Easily pulls down the screen

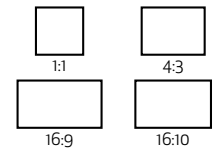

Multiple Aspect Ratios

MANUAL PROJECTION SCREENS:

- Available with aspect ratios: 16:9, 16:10, 4:3 and 1:1
- High quality aluminum cassette
- Slow retention & high quality details for longer life
- Market leading screen fabric gain 1.0
- Mounts for ceiling or wall installations included
- 30 centimeter black drop



M 1:1 Manual Projection Screens White Edition

Size:	Article Nr:	Projection Area:	Diagonal	Cassette colour:	Cassette material:	Surface:	Gain:	Wieght:	White drop:	Cassette size: (L*W*H)	Warranty:
80"	7350 073 73 7154	1,45x1,45m	2,03 m	White	Aluminum	Matte white	1,0	8 kg	30 cm	160x7,2x8,2 cm	1 year
96"	7350 073 73 7161	1,76 x1,76m	2,44 m	White	Aluminum	Matte white	1,0	8,5 kg	30 cm	181x7,2x8,2 cm	1 year
112"	7350 022 73 1981	2x2m	2,84 m	White	Aluminum	Matte white	1,0	9 kg	30 cm	213x7,2x8,2 cm	1 year
135"	7350 073 73 7178	2,4x2,4 m	3,45 m	White	Aluminum	Matte white	1,0	12 kg	30 cm	249x10x8,2 cm	1 year

M 4:3 Manual Projection Screen 200x150, 100"

Article No:	7 350 022 730 595
Format:	4:3
Size:	100"
Projection area:	2x1,5m
Diagonal:	2,54 m
Motor:	No
Remote:	No
Colour:	White
Surface:	Matte white
Gain:	1,0
Border:	4,5 cm
Weight:	9 kg
Black drop:	30 cm
Cassette material:	Aluminum
Cassette measurements:	213x7,2x8,2 cm (L°W°H)
Warranty:	1 year
Slow retention:	Built-in



M 16:9 Manual Projection Screen 200x112, 90"

Article No:	7 350 022 730 588
Format:	16:9
Size:	90"
Projection area:	2 x 1,12 m
Diagonal:	2,29 m
Motor:	No
Remote:	No
Colour:	White
Surface:	Matte white
Gain:	1,0
Border:	4,5 cm
Weight:	8 kg
Black drop:	30 cm
Cassette material:	Aluminum
Cassette measurements:	213x7,2x8,2 cm (L°W°H)
Warranty:	1 year
Slow retention:	Built-in



M 16:10 Manual Projection Screen 232x145, 108"

Article No:	7 350 022 735 682
Format:	16:10
Size:	108"
Projection area:	2,33 x 1,45 m
Diagonal:	2,74 m
Motor:	No
Remote:	No
Colour:	White
Surface:	Matte white
Gain:	1,0
Border:	4,5 cm
Weight:	11 kg
Black drop:	30 cm
Cassette material:	Aluminum
Cassette measurements:	248x7,2x8,2 cm (L°W°H)
Warranty:	1 year
Slow retention:	Built-in







be Screen[®]
BY MULTIBRACKETS

**TAKE YOUR
PRESENTATIONS TO
THE NEXT LEVEL**

**WITH HIGH-END
PROJECTION SCREENS**

**MOTORIZED PROJECTION
SCREENS DELUXE**

MOTORIZED PROJECTION SCREENS DELUXE

ELEGANT DESIGN & SUPERIOR MATERIAL CHOICES

Our motorized projection screens are designed to increase functionality and performance for today's presentation environments. Also by being motorized and not handled by hand it will last much longer than its manual counterparts. Crafted to strict Le Screen standards, these innovative screens are now available in widths from 77" to a massive 334" (or 8,5m diagonal).

Le Screen Motorized Screens also feature seamless height adjustments for a picture perfect reproduction in the most challenging environments. Le Screen standard fabric is a Gain 1.0 and our screen cloth is using a high levelled three layer technology. Le Screen can also custom produce screens with different fabrics built to a project's specification. Supporting most popular aspect ratios: 16:9, 16:10, 4:3, and 1:1 we are almost certain we have a Motorized Projection Screen that fits your needs.



Wall Receiver & RF Remote Control
Operates from long distances



Cleanable screen material
for easy maintenance

Superior screen material

The quality of screen material is the most important aspect of any projection screen. Most screens on the market will use a very basic compressed cloth type material resulting in a creased surface and poor contrast performance. The Le Screen Motorized Projection Screen Deluxe series use a high quality multi layered ply material with a high contrast and low gain of 1.0. The material is tear resistant, fireproof, anti wrinkle safe and is designed to hang flat. The centre layer is a glass fibre net producing a flex rate of less than 1% compared with the industry average of 33%. The front layer optimizes contrast and reflectivity while a black PVC backing prevents light leakage and helps retain a uniformly flat projection surface.

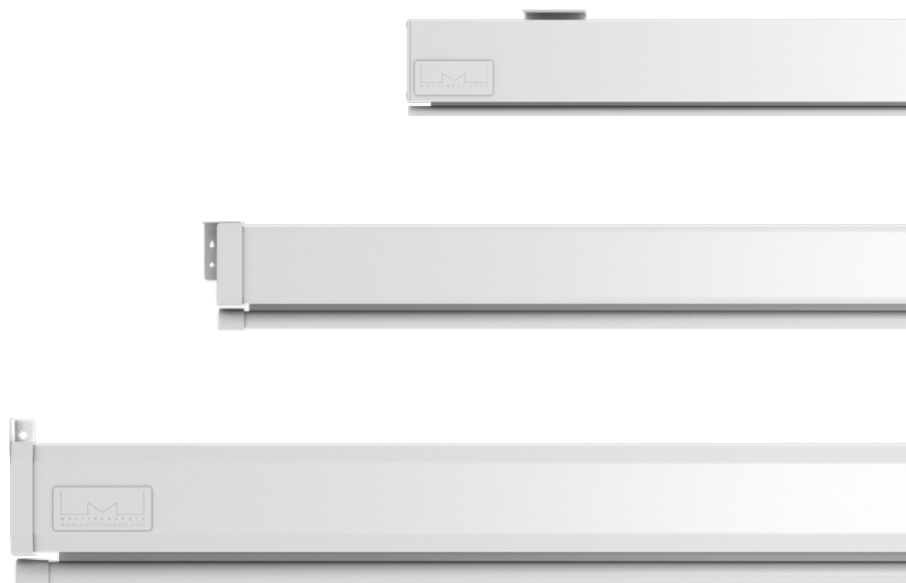



Multiple Aspect Ratios



Quiet Tubular Motor



CE-Quality Mark





High Quality Aluminum Case
Lightweight yet durable

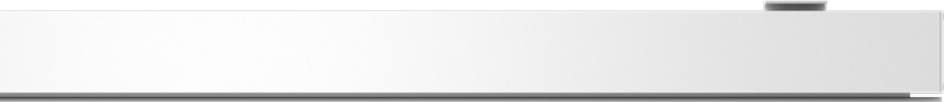
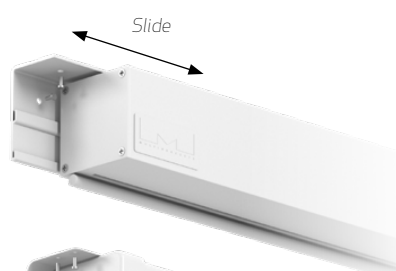

HIGHLIGHTS:

- Available with aspect ratios:16:9, 16:10, 4:3 and 1:1
- Adjustments possibilities are easy to reach inside the case
- Pre programmed final setting for rolling in and out of projection screen makes rapid installation possible
- All Motorized projection screens follows the product safety standards with CE-quality mark
- The motor with 28RPM is incredibly quiet
- Supplied with mounting details for ceiling and wall installation
- Matte white, double-sided laminated vinyl with black back, and fiber glass centre (three layered technology) gain 1.0, viewing angle over 50 degrees left and right,weight approximately 450g/m² and thickness approximately 0.45mm.
- Le Screen Motorized Projection Screens Deluxe support formats 16:9, 16:10, 4:3, and 1:1
- Black border of 4cm around the viewing area (16:9, 16:10 and 4:3)
- Black/white drop 30cm
- Case colors available in white and black
- Sliding wall mounts ensure the installation is properly centered.

MOUNTING METHOD DEPENDS ON CASSETTE TYPE

Cassette type/size:	Mounting method:	
 77" to 167"	SMALL A	
 180" to 226"	MEDIUM B	
 226" to 334"	LARGE C	



M1:1 Motorized Projection Screens - White Edition

Size:	Article Nr:	Projection Area:	Diagonal	Motor:	Remote:	Cassette colour:	Cassette material:	Surface:	Gain:	Wieght:	White drop:	Cassette size: (L*W*H)	Warranty:
80"	7 350 022 730 830	1,45x1,45 m	2,03 m	Yes	Yes	White	Aluminum	Matte white	1,0	11 kg	30 cm	158,4x9x9 cm	1 year
96"	7 350 022 731 721	1,72x1,72 m	2,44 m	Yes	Yes	White	Aluminum	Matte white	1,0	12 kg	30 cm	185,4x9x9 cm	1 year
112"	7 350 022 730 847	2x2 m	2,84 m	Yes	Yes	White	Aluminum	Matte white	1,0	14 kg	30 cm	213,4x9x9 cm	1 year
135"	7 350 022 731 738	2,4x2,4 m	3,43 m	Yes	Yes	White	Aluminum	Matte white	1,0	18 kg	30 cm	255,4x9x9 cm	1 year
167"	7 350 022 731 745	3x3 m	4,24 m	Yes	Yes	White	Aluminum	Matte white	1,0	19 kg	30 cm	315,4x9x9 cm	1 year
200"	7 350 022 731 752	3,6x3,6 m	5,08 m	Yes	Yes	White	Aluminum	Matte white	1,0	32 kg	30 cm	378x9,8x9,8 cm	1 year
278"	7 350 022 731 776	5x5 m	7,06 m	Yes	Yes	White	Aluminum	Matte white	1,0	150 kg	30 cm	518x15,3x15,3 cm	1 year
334"	7 350 022 731 783	6x6 m	8,48 m	Yes	Yes	White	Aluminum	Matte white	1,0	129 kg	30 cm	618x17,5x17,5 cm	1 year



M 4:3 Motorized Projection Screens

Size:	Article Nr:	Projection Area:	Diagonal	Motor:	Remote:	Cassette colour:	Cassette material:	Surface:	Gain:	Wieght:	Black drop:	Cassette size: (L*W*H)	Warranty:
86"	7 350 022 730 366	1,72x1,3m	2,18 m	Yes	Yes	White	Aluminum	Matte white	1,0	11 kg	30 cm	185,4x9x9 cm	1 year
100"	7 350 022 730 373	2x1,5m	2,54 m	Yes	Yes	White	Aluminum	Matte white	1,0	12 kg	30 cm	213,9x9x9 cm	1 year
120"	7 350 022 730 380	2,4x1,8m	3,05 m	Yes	Yes	White	Steel	Matte white	1,0	14 kg	30 cm	257x9x9 cm	1 year
150"	7 350 022 730 458	3x2,2m	3,81 m	Yes	Yes	White	Steel	Matte white	1,0	17 kg	30 cm	315,4x9x9 cm	1 year
180"	7 350 022 730 465	3,6x2,7m	4,57 m	Yes	Yes	White	Steel	Matte white	1,0	32 kg	30 cm	378x9,8x9,8 cm	1 year
200"	7 350 022 730 472	4x3 m	5,08	Yes	Yes	White	Steel	Matte white	1,0	38 kg	30 cm	418x9,8x9,8 cm	1 year
300"	7 350 022 730 496	6x4,5 m	7,62 m	Yes	Yes	White	Steel	Matte white	1,0	125 kg	30 cm	624x17,5x17,5 cm	1 year

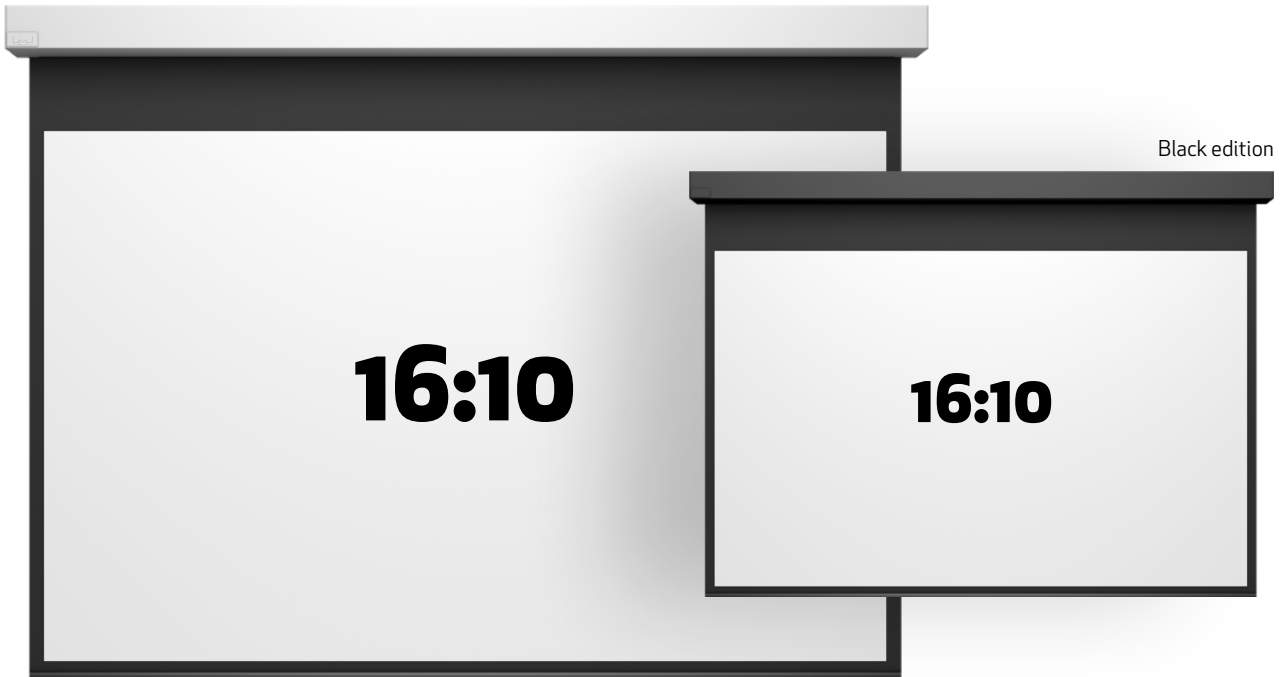

M16:10 Motorized Projection Screen

White cassette

Size:	Article Nr:	Projection Area:	Diagonal	Motor:	Remote:	Cassette colour:	Cassette material:	Surface:	Gain:	Border:	Wieght:	Black drop:	Cassette size: (L*W*H)	Warranty:
77"	7 350 022 730 403	1,72x0,97m	1,96 m	Yes	Yes	White	Aluminum	Matte white	1,0	4 cm	10 kg	30 cm	185,4x9x9 cm	1 year
90"	7 350 022 730 410	2x1,12m	2,29 m	Yes	Yes	White	Aluminum	Matte white	1,0	4 cm	12 kg	30 cm	215,4x8,2x7,2 cm	1 year
108"	7 350 022 730 427	2,4x1,35m	2,74 m	Yes	Yes	White	Aluminum	Matte white	1,0	4,5 cm	14 kg	30 cm	255,4x9x9 cm	1 year
135"	7 350 022 730 526	3x1,68m	3,43 m	Yes	Yes	White	Aluminum	Matte white	1,0	4 cm	18 kg	30 cm	317x10x8,2 cm	1 year
162"	7 350 022 730 533	3,6x2 m	4,11 m	Yes	Yes	White	Steel	Matte white	1,0	4,5 cm	34 kg	30 cm	378x9,8x9,8 cm	1 year
180"	7 350 022 730 540	4x2,25m	4,57 m	Yes	Yes	White	Steel	Matte white	1,0	4,5 cm	36 kg	30 cm	418x9,8x9,8 cm	1 year
226"	7 350 022 730 557	5x2,81m	5,74 m	Yes	Yes	White	Steel	Matte white	1,0	5,5 cm	130 kg	30 cm	518x15,3x15,3 cm	1 year
280"	7 350 022 730 564	6x3,38m	7,11 m	Yes	Yes	White	Steel	Matte white	1,0	5,5 cm	122 kg	30 cm	618x17,5x17,5 cm	1 year

Black edition (Black cassette, black wall remote & black remote control)

Size:	Article Nr:	Projection Area:	Diagonal	Motor:	Remote:	Cassette colour:	Cassette material:	Surface:	Gain:	Border:	Wieght:	Black drop:	Cassette size: (L*W*H)	Warranty:
77"	7 350 022 733 978	1,72x0,97m	1,96 m	Yes	Yes	Black	Aluminum	Matte white	1,0	4,5 cm	10 kg	30 cm	185,4x9x9 cm	1 year
90"	7 350 022 732 629	2x1,12m	2,29 m	Yes	Yes	Black	Aluminum	Matte white	1,0	4,5 cm	12 kg	30 cm	213,4x9x9 cm	1 year
108"	7 350 022 732 636	255,4x9x9 cm	2,74 m	Yes	Yes	Black	Aluminum	Matte white	1,0	4,5 cm	15 kg	30 cm	255,4x9x9 cm	1 year
135"	7 350 022 733 985	3x1,68m	3,43 m	Yes	Yes	Black	Aluminum	Matte white	1,0	4,5 cm	18 kg	30 cm	315,4x9x9 cm	1 year

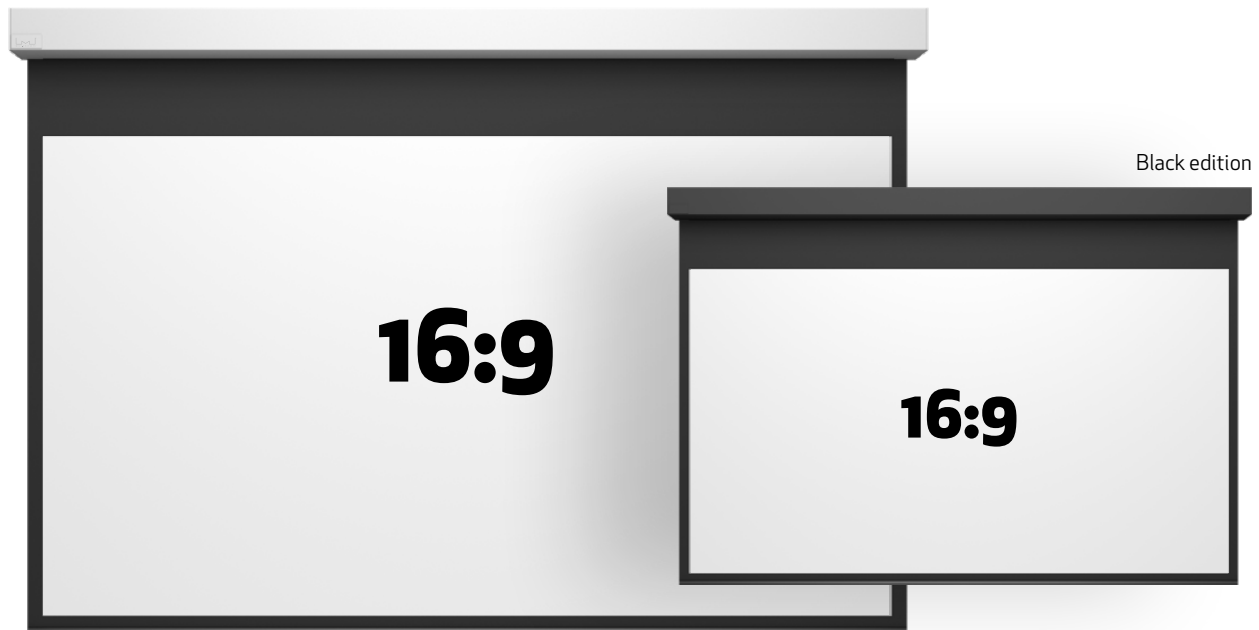

M16:9 Motorized Projection Screen

White cassette

Size:	Article Nr:	Projection Area:	Diagonal	Motor:	Remote:	Cassette colour:	Cassette material:	Surface:	Gain:	Border:	Wieght:	Black drop:	Cassette size: (L*W*H)	Warranty:
77"	7350 022 735 569	1,659 x 1,037 m	196 cm	Yes	Yes	White	Aluminum	Matte white	1,0	4 cm	11 kg	30 cm	180,9 x 9 x 9 cm	1 year
90"	7350 022 735 583	1,939 x 1,212 m	229 cm	Yes	Yes	White	Aluminum	Matte white	1,0	4 cm	14 kg	30 cm	208,9 x 9 x 9 cm	1 year
108"	7350 022 735 606	2,326 x 1,454 m	274 cm	Yes	Yes	White	Aluminum	Matte white	1,0	4 cm	16 kg	30 cm	247,6 x 9 x 9 cm	1 year
135"	7350 022 735 620	2,908 x 1,817 m	343 cm	Yes	Yes	White	Aluminum	Matte white	1,0	4 cm	19 kg	30 cm	307,8 x 9 x 9 cm	1 year
162"	7350 022 735 644	3,489 x 2,18 m	411 cm	Yes	Yes	White	Steel	Matte white	1,0	4 cm	33 kg	30 cm	364,9 x 10 x 10 cm	1 year
180"	7350 022 735 651	3,877 x 2,432 m	458 cm	Yes	Yes	White	Steel	Matte white	1,0	4 cm	35 kg	30 cm	402,7 x 10 x 10 cm	1 year
226"	7350 022 735 668	4,868 x 3,042 m	574 cm	Yes	Yes	White	Steel	Matte white	1,0	4 cm	45 kg	30 cm	512,8 x 10 x 10 cm	1 year
280"	7350 022 735 675	6,031 x 3,77 m	711 cm	Yes	Yes	White	Steel	Matte white	1,0	4 cm	50 kg	30 cm	629,1 x 17 x 17 cm	1 year

Black edition (Black cassette, black wall remote & black remote control)

Size:	Article Nr:	Projection Area:	Diagonal	Motor:	Remote:	Cassette colour:	Cassette material:	Surface:	Gain:	Border:	Wieght:	Black drop:	Cassette size: (L*W*H)	Warranty:
77"	7350 022 735 576	1,659 x 1,037 m	196 cm	Yes	Yes	Black	Aluminum	Matte white	1,0	4,5 cm	11 kg	30 cm	180,9 x 9 x 9 cm	1 year
90"	7350 022 735 590	1,939 x 1,212 m	229 cm	Yes	Yes	Black	Aluminum	Matte white	1,0	4,5 cm	14 kg	30 cm	208,9 x 9 x 9 cm	1 year
108"	7350 022 735 613	2,326 x 1,454 m	274 cm	Yes	Yes	Black	Aluminum	Matte white	1,0	4,5 cm	16 kg	30 cm	247,6 x 9 x 9 cm	1 year
135"	7350 022 735 637	2,908 x 1,817 m	343 cm	Yes	Yes	Black	Aluminum	Matte white	1,0	4,5 cm	16 kg	30 cm	307,8 x 9 x 9 cm	1 year

ACCESSORIES

Motorized Projection Screens

MIR Receiver / Transmitter Kit

Article No:	7 350 022 73 2315
Colour:	White
Material:	Plastic
Warranty:	1 year
Signal frequency:	38 KHz

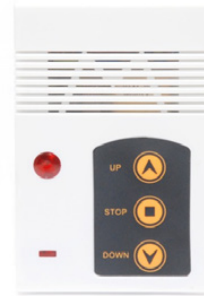

M12V Trigger Kit for MB Motorized Screens

Article No:	7 350 022 73 3770
Colour:	White
Material:	Plastic
Warranty:	1 year
Signal frequency:	38 KHz
Voltage:	220 V



Control Box

Article No:	7 350 073 73 9868
Colour:	White
Material:	Plastic
Warranty:	1 year
Signal frequency:	38 KHz



PARTS

Motorized / Manual Projection screens



Pair of Wall / Ceiling Mount
for Manual & Motorized Screens up to 135"

Article No (white):	7 350 073 73 9875
Article No (black):	7 350 073 73 9882
Material:	Metal
Warranty:	5 years



Black Drop Stick

Article No:	7 350 073 73 9899
Colour:	Yellow
Material:	Plastic
Warranty:	5 year



M Wall-Remote Control Black
for Motorized Screens

Article No:	7 350 073 73 9905
Colour:	Black
Material:	Plastic
Warranty:	1 year
Signal frequency:	38 KHz
Voltage:	220 V



M Remote Control Black
for Motorized Screens

Article No:	7 350 073 73 9929
Colour:	Black
Material:	Plastic
Warranty:	1 year
Signal frequency:	38 KHz
Voltage:	12 V



M Wall-Remote Control White
for Motorized Screens

Article No:	7 350 073 73 9912
Colour:	White
Material:	Plastic
Warranty:	1 year
Signal frequency:	38 KHz
Voltage:	220 V



M Remote Control White
for Motorized Screens

Article No:	7 350 073 73 9936
Colour:	White
Material:	Plastic
Warranty:	1 year
Signal frequency:	38 KHz
Voltage:	220 V





le Screen[®]

BY MULTIBRACKETS

**FRAMED PROJECTION
SCREENS**

FRAMED PROJECTION SCREENS

ELEGANT DESIGN & SUPERIOR MATERIAL CHOICES

Our ultra flat framed screens reach a perfectly smooth surface. With a frame that is just 30 mm thick, it looks rather like an LCD than a projection screen. It's simple and linear shape harmonizes beautifully. Available from 77" to massive 226".

Our Framed series is a best seller in EU perfect for Boardrooms, Corporate Information Suites, Reception areas and other prestige business locations. Our line of framed screens are also perfect for smaller viewing theatres, visitor centers, museums and other select presentation venues. The screens are based on a high quality screen cloth. Producing a 1.0 gain with a superior extra wide viewing angle.

Our Framed screens use a simply ingenious tensioning system, you're sure to get a wrinklefree and super straight image every time. Le Screen framed screen value means big audiences get big screens without having to compromise on the experience. The result is a viewing environment that delivers on movie makers creative vision. A result so immersive it must be experienced.

Our series Fixed projection screens are tailored to fit the bill for high-end fixed screens and viewers wanting high quality and good economy. Selected framed screens has the option to use Le Screen Grey Plus Cloth (Gain 0.9) or our Acoustically transparent screen technology.

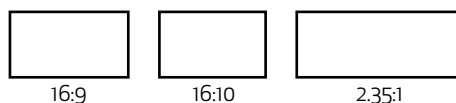
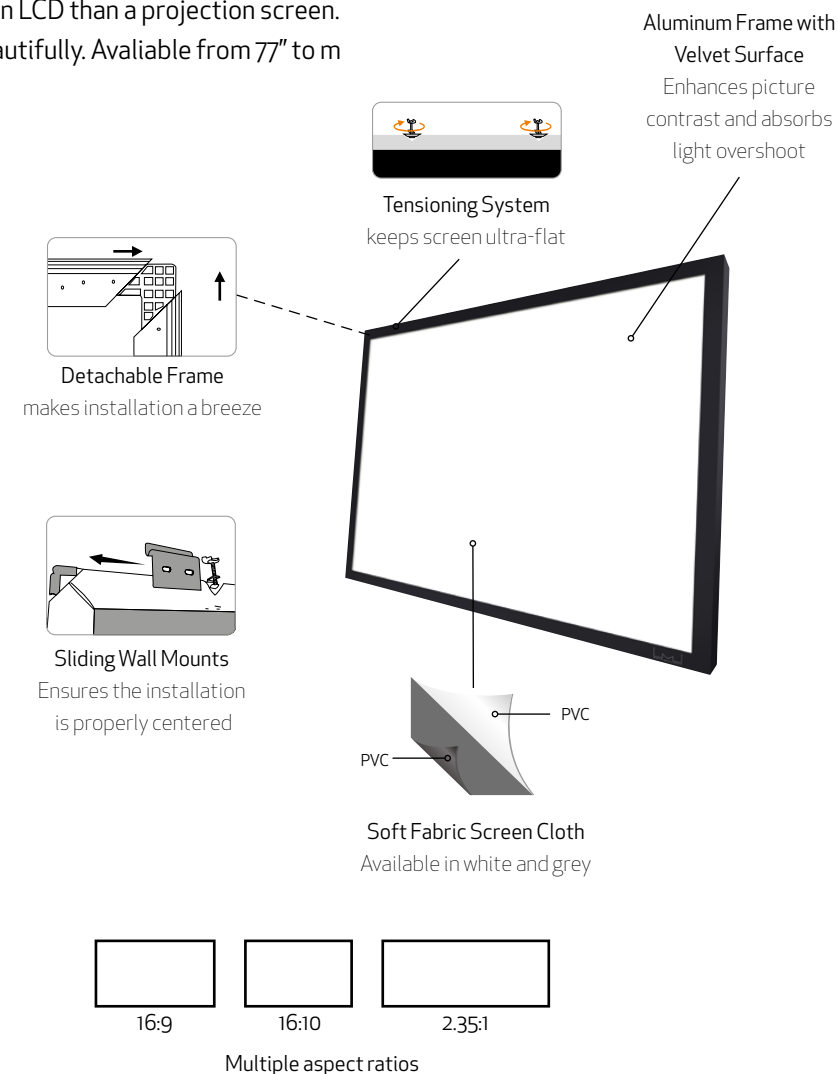

Multiple aspect ratios

FRAMED PROJECTION SCREENS

- Multiple aspect ratios available: 16:9, 16:10 and 2.35:1
- Highly versatile 1.0 flat-tensioned screen material with standard black backing to eliminate light penetration.
- Aluminum contour frame surfaced with black velvet to enhance picture contrast and absorb light overshoot.
- Slide-on wall mount is horizontally adjustable for easy centering.
- Designed for high performance Home Cinema Projectors.

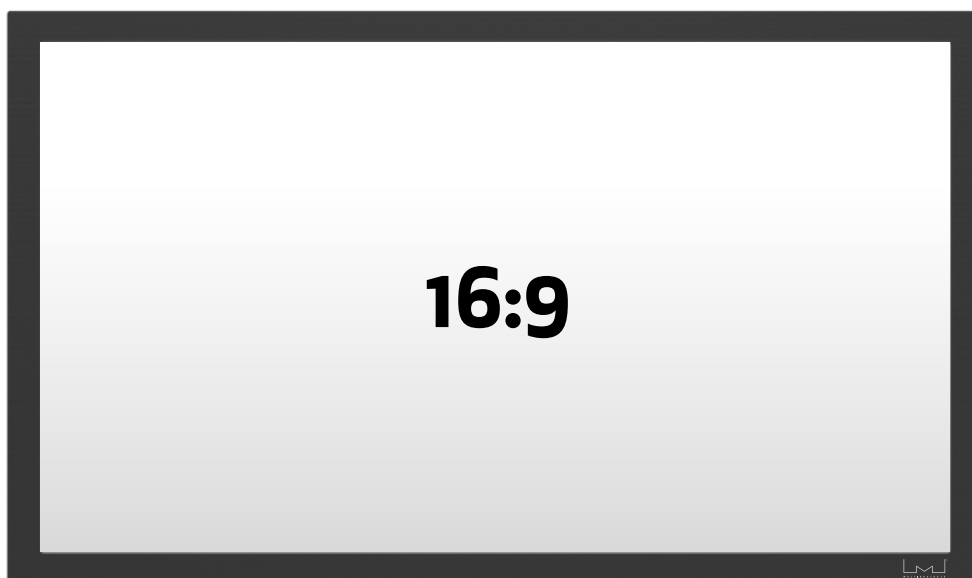

M 16:9 Framed Projection Screen

Size:	Article Nr:	Projection Area:	Diagonal	Frame colour:	Surface:	Gain:	Frame:	Wieght:	Single package measurements:	Warranty:
77"	7 350 022 731 936	1,72 x 0,97 m	1,96 m	Black	Matte white	1,0	8 cm	11 kg	190 x 22 x 14 cm	1 year
90"	7 350 022 730 724	2 x 1,12 m	2,29 m	Black	Matte white	1,0	8 cm	12 kg	218 x 22 x 14 cm	1 year
100"	7 350 022 733 473	2,21 x 1,26 m	2,92 m	Black	Matte white	1,0	8 cm	13 kg	240 x 22 x 14 cm	1 year
108"	7 350 022 732 964	2,40 x 1,35 m	2,74 m	Black	Matte white	1,0	8 cm	15 kg	258 x 22 x 14 cm	1 year
120"	7 350 022 733 619	2,65 x 1,49 m	3,5 m	Black	Matte white	1,0	8 cm	16 kg	283 x 22 x 14 cm	1 year
135"	7 350 022 732 971	3,00 x 1,68 m	3,43 m	Black	Matte white	1,0	8 cm	17 kg	318 x 22 x 14 cm	1 year
150"	7 350 022 733 626	3,32 x 1,86 m	4,37 m	Black	Matte white	1,0	8 cm	24 kg	350 x 22 x 14 cm	1 year
162"	7 350 022 733 633	3,58 x 2,04 m	4,73 m	Black	Matte white	1,0	12 cm	34 kg	404 x 23,5 x 23,5 cm	1 year
180"	7 350 022 733 640	3,98 x 2,26 m	5,26 m	Black	Matte white	1,0	12 cm	40 kg	444 x 23,5 x 23,5 cm	1 year
226"	7 350 022 733 657	4,99 x 2,84 m	6,60 m	Black	Matte white	1,0	12 cm	50 kg	544 x 23,5 x 23,5 cm	1 year

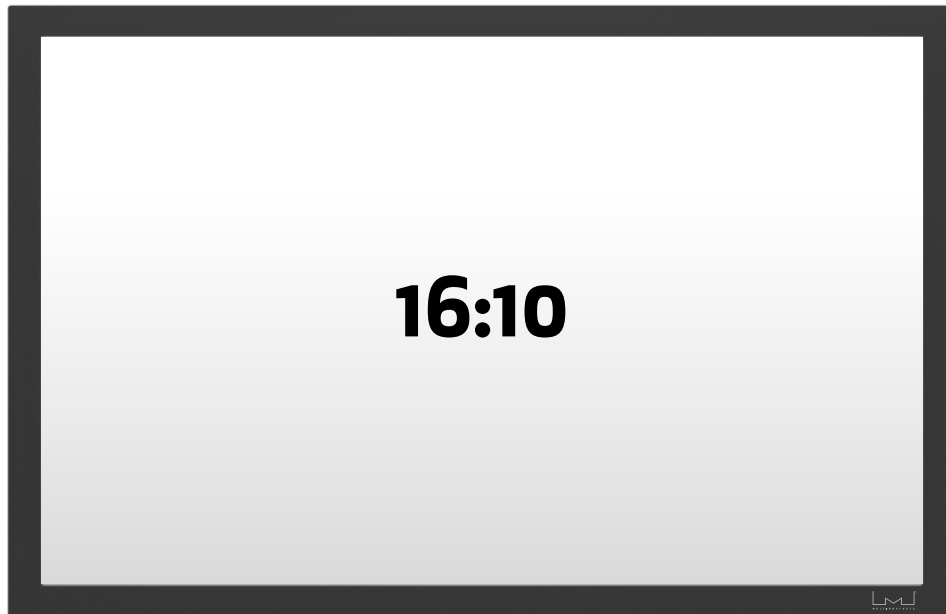

M16:10 Framed Projection Screen

Size:	Article Nr:	Projection Area:	Diagonal	Frame colour:	Surface:	Gain:	Frame:	Wieght:	Single package measurements:	Warranty:
77"	7350 022 735 750	1,66 x 1,04 m	1,95 m	Black	Matte white	1,0	8 cm	10 kg	185 x 22 x 14 cm	1 year
90"	7350 022 735 767	1,94 x 1,21 m	2,29 m	Black	Matte white	1,0	8 cm	12 kg	212 x 22 x 14 cm	1 year
100"	7350 022 735 774	2,15 x 1,35 m	2,54 m	Black	Matte white	1,0	8 cm	14 kg	234 x 22 x 14 cm	1 year
108"	7350 022 735 781	2,33 x 1,62 m	2,74 m	Black	Matte white	1,0	8 cm	15 kg	233 x 1,62 m	1 year
120"	7350 022 735 798	2,59 x 1,62 m	3,05 m	Black	Matte white	1,0	8 cm	15 kg	259 x 1,62 m	1 year
135"	7350 022 735 804	2,91 x 1,82 m	3,43 m	Black	Matte white	1,0	8 cm	20 kg	2,91 x 1,82 m	1 year
150"	7350 022 735 811	3,23 x 2,02 m	3,81 m	Black	Matte white	1,0	8 cm	34 kg	341 x 22 x 14 cm	1 year
162"	7350 022 735 828	3,49 x 2,18 m	4,11 m	Black	Matte white	1,0	12 cm	36 kg	393 x 23,5 x 23,5 cm	1 year
180"	7350 022 735 835	3,88 x 2,42 m	4,57 m	Black	Matte white	1,0	12 cm	41 kg	32 x 23,5 x 23,5 cm	1 year
226"	7350 022 735 842	4,87 x 3,04 m	5,74 m	Black	Matte white	1,0	12 cm	48 kg	531 x 23,5 x 23,5 cm	1 year

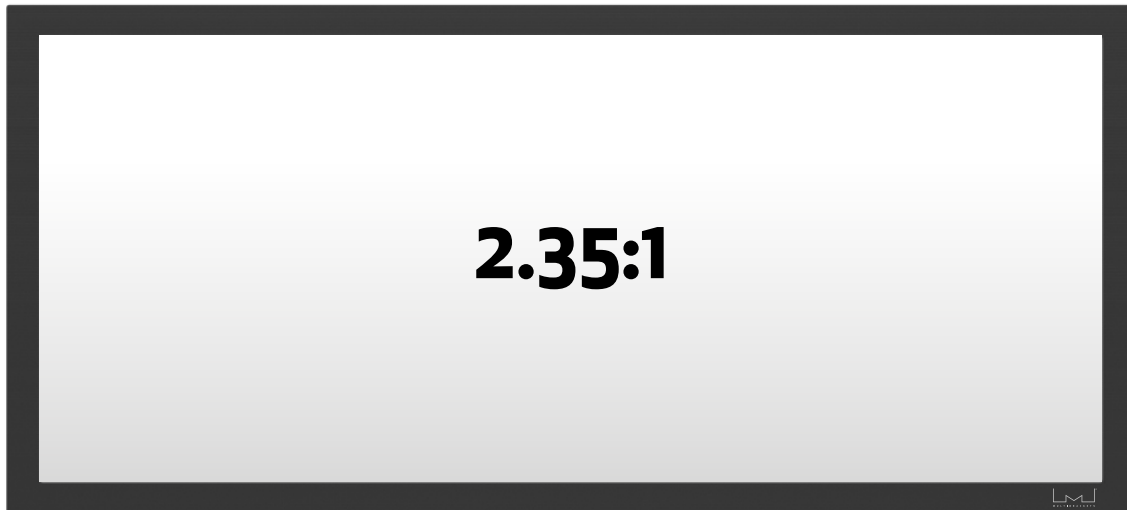

M 2.35:1 Framed Projection Screen

Size:	Article Nr:	Projection Area:	Diagonal:	Frame colour:	Surface:	Gain:	Frame:	Wiegth:	Single package measurements:	Warranty:
84"	7 350 022 732 551	1,97x0,84 m	2,13 m	Black	Matte white	1,0	8 cm	11 kg	215 x 22 x 14 cm	1 year
90"	7 350 022 732 568	2,11 x 0,9 m	2,29 m	Black	Matte white	1,0	8 cm	12 kg	230 x 22 x 14 cm	1 year
100"	7 350 022 732 575	2,34 x 1 m	2,54 m	Black	Matte white	1,0	8 cm	14 kg	252 x 22 x 14 cm	1 year
108"	7 350 022 732 582	2,81 x 1,2 m	3,05 m	Black	Matte white	1,0	8 cm	16 kg	300 x 22 x 14 cm	1 year
120"	7 350 022 734 531	2,54 x 1,08 m	2,74 m	Black	Matte white	1,0	8 cm	15 kg	272 x 22 x 14 cm	1 year
135"	7 350 022 734 548	3,17 x 1,35 m	3,43 m	Black	Matte white	1,0	8 cm	20 kg	335 x 22 x 14 cm	1 year
150"	7 350 022 734 555	3,43 x 1,46 m	3,73 m	Black	Matte white	1,0	12 cm	30 kg	387 x 23,5 x 23,5 cm	1 year
162"	7 350 022 734 562	3,78 x 1,61 m	4,11 m	Black	Matte white	1,0	12 cm	36 kg	422 x 23,5 x 23,5 cm	1 year
180"	7 350 022 734 579	4,23 x 1,8 m	4,57 m	Black	Matte white	1,0	12 cm	41 kg	467 x 23,5 x 23,5 cm	1 year
200"	7 350 022 734 586	4,6 x 1,95 m	5,08 m	Black	Matte white	1,0	12 cm	45 kg	504 x 23,5 x 23,5 cm	1 year

M GREY PLUS EXTRA CLOTH

GET THE BEST PICTURE QUALITY FOR THEIR FIXED FRAME SOLUTION

This projection screen surface is optimized for any user striving to get the best picture quality for their fixed frame solution. Overall the M Grey Plus generally provides higher contrast and better colour rendition than a standardized matte white projection screen surface.

The grey screen surface is the perfect choice when video images are the main source of information being projected and where ambient lighting is moderately controlled. With its specially designed grey base surface and a reflective top surface, this screen material is able to provide very good black levels without sacrificing the white level output. With its enhanced black levels and brilliant white levels, this screen surface provides deep life-like colours and greater detail and sharpness to the image.

M Grey Plus projection screen surface ensures a dramatic improvement of contrast display for any projector.

M Grey Plus is available in all fixed framed screens sizes, and is purchased separately.

GAIN: SCREEN REFLECTIVITY

The image luminance is the overall image brightness created by the combination of projector output and screen reflectivity. Projection screens vary in their reflective properties. The reflective neutral matte white screen is typically 1.0 gain but can vary as high as 1.4 in its reflectivity. Negative gain projection screens are designed to enhance

contrast levels at the expense of having less reflectivity. They are typically measured between 0.5 to 0.9 gain. Ambient Light Rejecting or ALR projection screens typically perform in the realm positive gain, or anything higher than 1.0 to 1.8 gain. These screens are known for superior brightness and image saturation, however they can also be negative gain as heavy contrast layers are incorporated to enhance darkness levels for superior image quality.

0.9 GAIN

Negative gain projection screens are designed to enhance contrast levels at the expense of having less reflectivity.

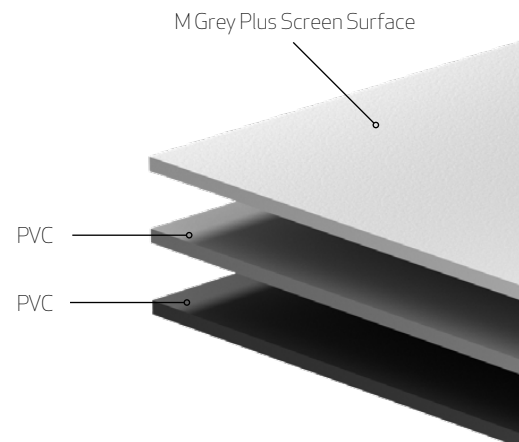
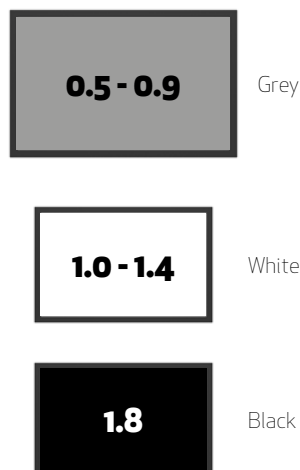

16:10

Size:	Article Nr:	Format:	Gain:	Frame:	Warranty:
77"	7 350 022 735 873	16:10	0,9	Not included	1 year
90"	7 350 022 735 880	16:10	0,9	Not included	1 year
100"	7 350 022 735 897	16:10	0,9	Not included	1 year
108"	7 350 022 735 903	16:10	0,9	Not included	1 year
120"	7 350 022 735 910	16:10	0,9	Not included	1 year
135"	7 350 022 735 927	16:10	0,9	Not included	1 year
150"	7 350 022 735 934	16:10	0,9	Not included	1 year
162"	7 350 022 735 941	16:10	0,9	Not included	1 year
180"	7 350 022 735 958	16:10	0,9	Not included	1 year
226"	7 350 022 735 965	16:10	0,9	Not included	1 year

16:9

Size:	Article Nr:	Format:	Gain:	Frame:	Warranty:
77"	7 350 022 734 708	16:9	0,9	Not included	1 year
90"	7 350 022 734 715	16:9	0,9	Not included	1 year
100"	7 350 022 734 722	16:9	0,9	Not included	1 year
108"	7 350 022 734 739	16:9	0,9	Not included	1 year
120"	7 350 022 734 746	16:9	0,9	Not included	1 year
135"	7 350 022 734 753	16:9	0,9	Not included	1 year
150"	7 350 022 734 760	16:9	0,9	Not included	1 year
162"	7 350 022 734 777	16:9	0,9	Not included	1 year
180"	7 350 022 734 784	16:9	0,9	Not included	1 year
226"	7 350 022 734 791	16:9	0,9	Not included	1 year

2.35:1

Size:	Article Nr:	Format:	Gain:	Frame:	Warranty:
84"	7 350 022 734 807	2,35:1	0,9	Not included	1 year
90"	7 350 022 734 814	2,35:1	0,9	Not included	1 year
100"	7 350 022 734 821	2,35:1	0,9	Not included	1 year
108"	7 350 022 734 838	2,35:1	0,9	Not included	1 year
120"	7 350 022 734 845	2,35:1	0,9	Not included	1 year
135"	7 350 022 734 852	2,35:1	0,9	Not included	1 year
150"	7 350 022 734 869	2,35:1	0,9	Not included	1 year
162"	7 350 022 734 876	2,35:1	0,9	Not included	1 year
180"	7 350 022 734 883	2,35:1	0,9	Not included	1 year
200"	7 350 022 734 890	2,35:1	0,9	Not included	1 year



- Multi-layer PVC (Polyvinyl chloride) with texture and surface coating
- Surface can be cleaned with mild soap and water
- Exceptional picture quality

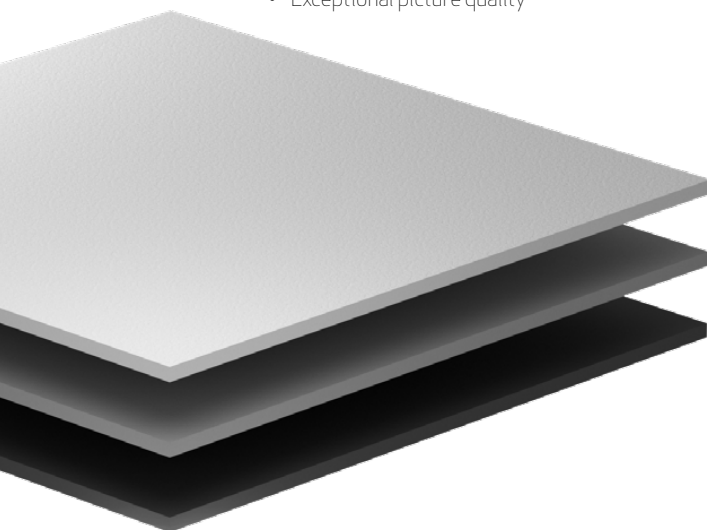



Mission

Le Screen's mission is to make High-end Quality Projection Screens available to every budget without compromising the product quality.

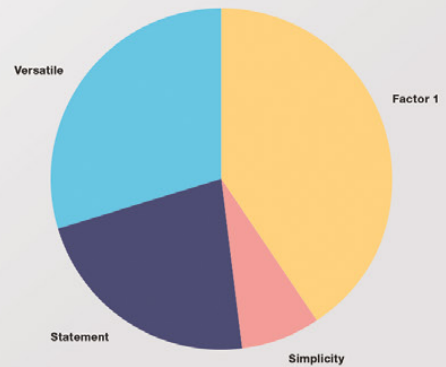



**PORTABLE PROJECTION
SCREENS**

M PORTABLE PROJECTION SCREEN EXTREMELY LIGHTWEIGHT AND PORTABLE

SUITABLE FOR PROFESSIONAL USE FOR PEOPLE ON THE GO

Our portable projection screens are designed to be easy to bring along. The screen unfolds with a scissor like structure, making it easy to use in cramped up places. These screens are easy to use, lightweight and truly portable. Perfect if you are on the go.

PORTABLE PROJECTION SCREENS

- The flexible tensioning arms makes it possible for the screen to unfold with precision and quality
- The MPortable Projection screen has two rotatable feet ensuring stability
- An extra strong case makes the unit handle travelling with ease
- Available with aspect ratios 16:9, 16:10, 4:3 and 1:1
- Available from 54" to 100"

SET UP AS EASY AS 1-2-3

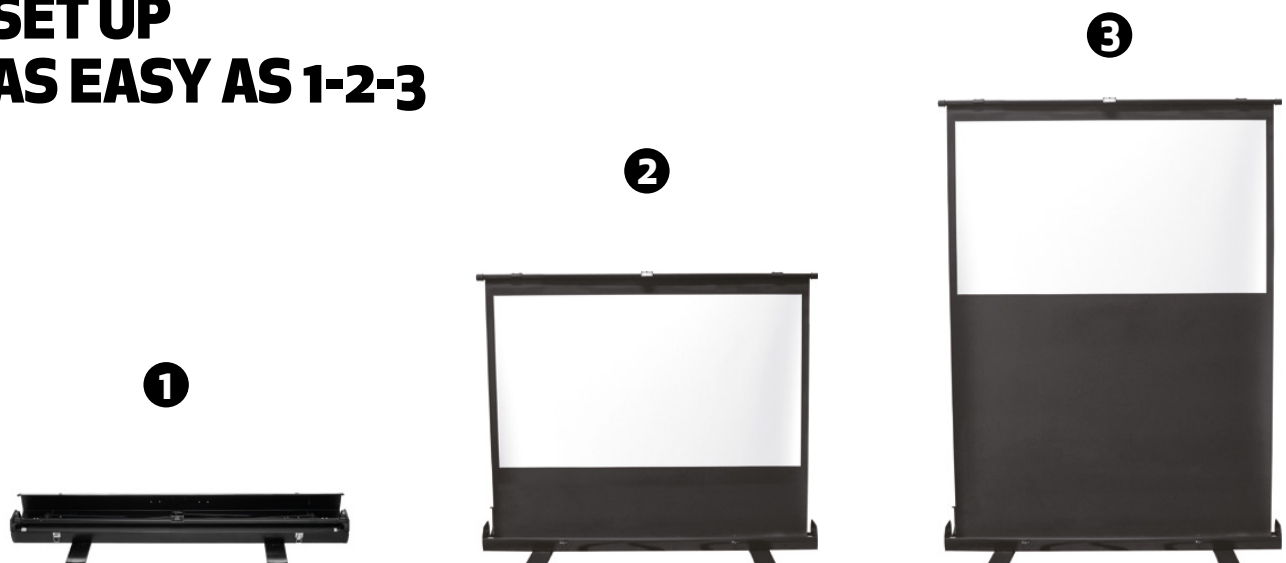



High Quality 3-Layer Screen Cloth
anti-wrinkle and tear resistant

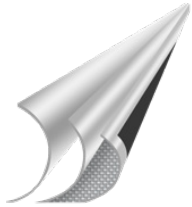

Cleanable Screen Material
for easy maintenance



Flexible Tensioning Arms
make it possible for the screen to unfold
with precision and quality



Aluminum Case with Built-in Carrying Handle
for safe and convenient transport



Locking Latches
for added safety during transport



Rotable Feet
for stability

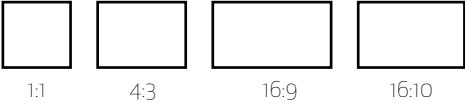

Multiple Aspect Ratios

M 1:1 Portable Projection Screen



Size:	Article Nr:	Projection Area:	Diagonal	Colour:	Surface:	Gain:	Border:	Wieght:	Single package measurements:	Warranty:
54"	7 350 022 731 974	100 x 100 cm	137 cm	Black	Matte white	1,0	3 cm	9 kg	185,4 x 9 x 9 cm	1 year
67"	7 350 022 731 790	120 x 120 cm	170 cm	Black	Matte white	1,0	3 cm	12 kg	213,4 x 9 x 9 cm	1 year
80"	7 350 022 731 806	145 x 145 cm	203 cm	Black	Matte white	1,0	3 cm	13 kg	255,4 x 9 x 9 cm	1 year

M 4:3 Portable Projection Screen



Size:	Article Nr:	Projection Area:	Diagonal	Colour:	Surface:	Gain:	Border:	Wieght:	Single package measurements:	Warranty:
60"	7 350 022 730 632	120 x 90 cm	152 cm	Black	Matte white	1,0	3 cm	12 kg	140 x 17 x 17 cm	1 year
86"	7 350 022 731 851	172 x 130 cm	218 cm	Black	Matte white	1,0	3 cm	15 kg	192 x 17 x 17 cm	1 year
100"	7 350 022 731 868	200 x 150 cm	254 cm	Black	Matte white	1,0	3 cm	16 kg	220 x 17 x 17 cm	1 year

M 16:9 Portable Projection Screen



Size:	Article Nr:	Projection Area:	Diagonal	Colour:	Surface:	Gain:	Border:	Wieght:	Single package measurements:	Warranty:
54"	7350 022 730 625	120 x 67 cm	137 cm	Black	Matte white	1,0	3 cm	11 kg	140 x 17 x 17 cm	1 year
77"	7350 022 731 820	172 x 97 cm	196 cm	Black	Matte white	1,0	3 cm	14 kg	192 x 17 x 17 cm	1 year
90"	7350 022 731 837	200 x 112 cm	229 cm	Black	Matte white	1,0	3 cm	16 kg	219 x 17 x 17 cm	1 year

M 16:10 Portable Projection Screen



Size:	Article Nr:	Projection Area:	Diagonal	Colour:	Surface:	Gain:	Border:	Wieght:	Single package measurements:	Warranty:
54"	7350 022 735 699	116,3x72,7 cm	137,2 cm	Black	Matte white	1,0	3 cm	12 kg	140 x 17 x 17 cm	1 year
77"	7350 022 735 712	165,9x103,7 cm	195,6 cm	Black	Matte white	1,0	3 cm	15 kg	187 x 17 x 17 cm	1 year
90"	7350 022 735 729	193,9x121,2 cm	228,7 cm	Black	Matte white	1,0	3 cm	17 kg	215 x 17 x 17 cm	1 year



ISE Barcelona
SHOW

The largest show in
the AV industry.

WELC
TO OUR
COMI

A man in a light-colored shirt and dark pants stands on a stage, gesturing towards a large projection screen. The screen displays a modern building with a grid of windows and the text 'WELCOME TO COMPANY'. The background is a dark, textured wall. The foreground shows the silhouettes of an audience.

WELCOME
TO
COMPANY

**QUICK FOLD
PROJECTION SCREENS**

QUICK FOLD PROJECTION SCREENS

EASY TO TRANSPORT BETWEEN DIFFERENT LOCATIONS

Le Screen Quick Fold Projection Screen are elegant projection screens designed for flexibility and easy transport. The perfect choice if you are looking for a flexible projection screen solution. It is easy to move between rooms and easy to transport between different locations.

Suited for commercial presentations, residential home cinemas, sport bars etc. This is ideal for both indoor and outdoor presentations. It only takes minutes to install and assemble. Flight case design makes it convenient for you to carry it with you and aluminum frame case helps to enhance screen surface tension. Wide selections of sizes are provided to meet your diverse needs.

Aspect Ratios:

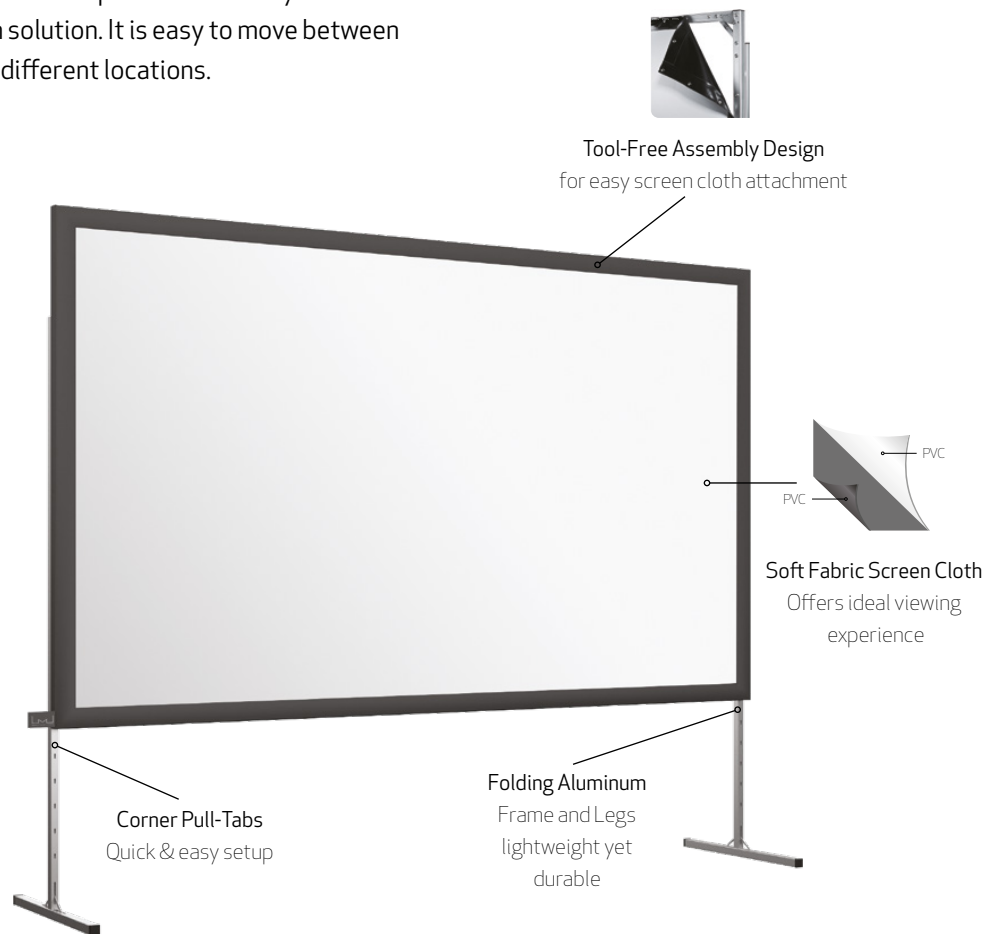
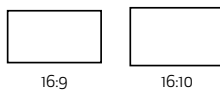

QUICK FOLD PROJECTION SCREENS

- Offering a clear picture with 140° viewing angle
- Ensures toolless height adjustment with Locking Rotary Knob
- Tool-Free Assembly Design: allows set-up in minutes by simply unfolding and locking frame, snapping on projection material and inserting legs
- Enhance picture contrast with the 4-sides black Masking Borders
- 1.1 Gain: Help you enjoy vibrant images through preventing light from muddying the colors on the screen
- Aluminum Flight Case: Ideal for travel and protects the screen when not in use
- Available in 16:9 and 16:10 aspect ratios



Rugged Flight Case with Rotating Clasps and Wheels
Ideal for storage and transport

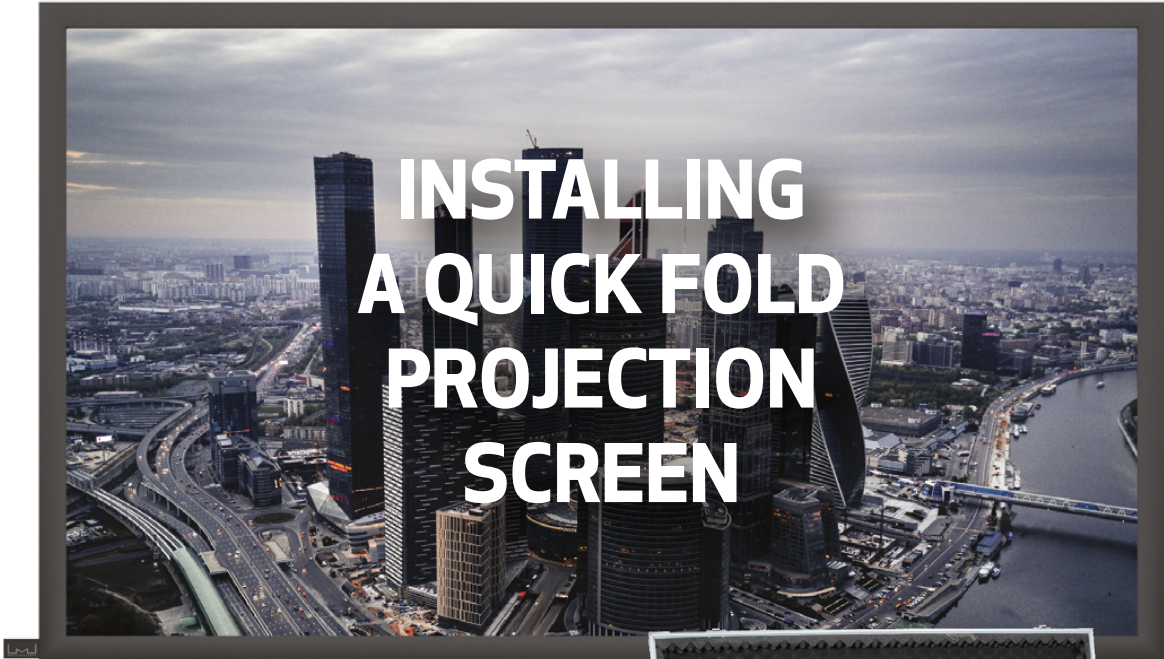

INSTALLING A QUICK FOLD PROJECTION SCREEN

The rental industry is the ultimate test for the reliability and quality of any AV Equipment. Le Screen Fast Fold screens are used by rental companies throughout EU every day.



M Quick Fold
Projection Screen 16:9
120" to 180"

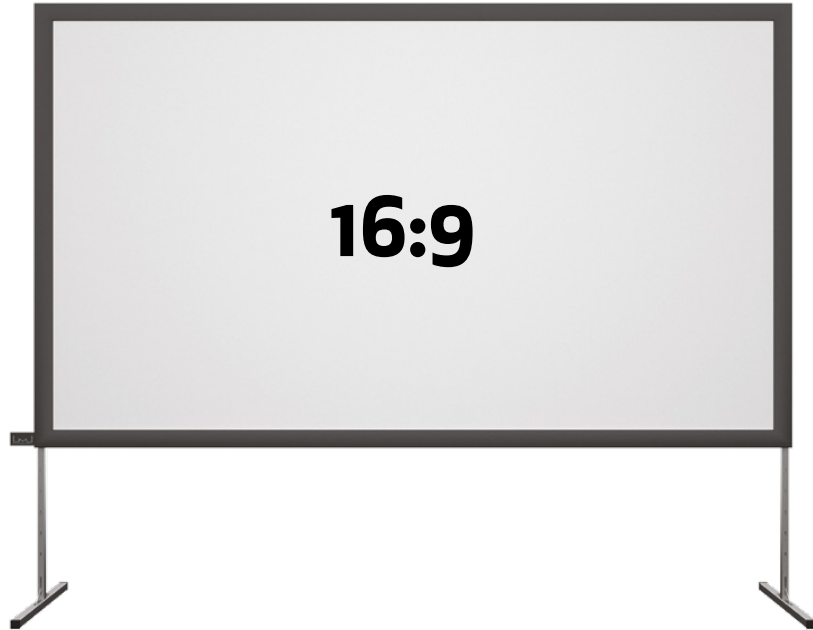

Size:	Article Nr:	Projection Area:	Diagonal	Frame colour:	Surface:	Gain:	Frame:	Wieght:	Single package measurements:	Warranty:
120"	7 350 073 731 916	265 x 149 cm	304 cm	Black	Matte white	1,0	7 cm	25 kg	185 x 22 x 14 cm	1 year
150"	7 350 073 731 923	332 x 187 cm	381 cm	Black	Matte white	1,0	7 cm	29 kg	212 x 22 x 14 cm	1 year
180"	7 350 073 731 930	400 x 225 cm	458.9 cm	Black	Matte white	1,0	7 cm	44 kg	234 x 22 x 14 cm	1 year

M Quick Fold
Projection Screen 16:9
200" to 300"

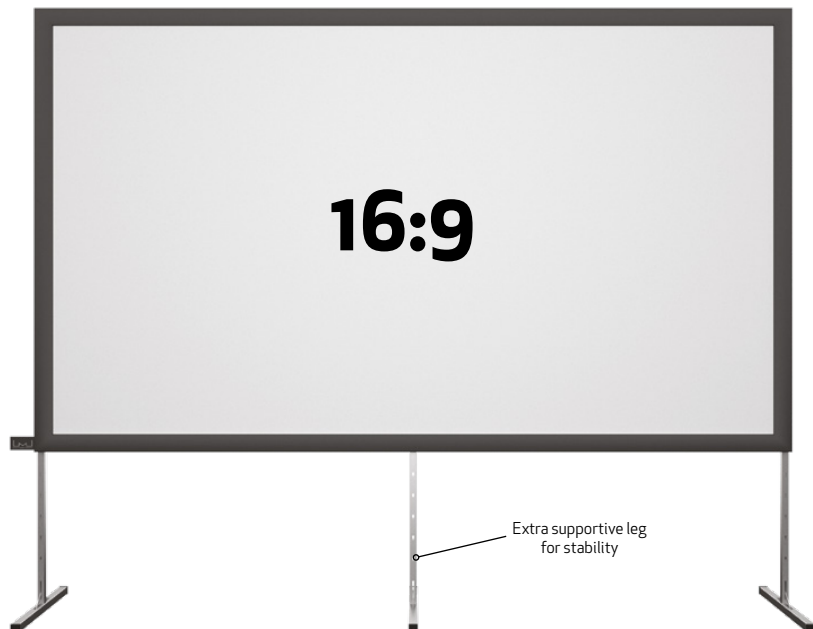

Size:	Article Nr:	Projection Area:	Diagonal	Frame colour:	Surface:	Gain:	Frame:	Wieght:	Single package measurements:	Warranty:
200"	7 350 073 731 947	443 x 249 cm	508.2 cm	Black	Matte white	1,0	7 cm	51 kg	2,33 x 1,62 m	1 year
250"	7 350 073 731 954	554 x 312 cm	635.8 cm	Black	Matte white	1,0	7 cm	66 kg	2,59 x 1,62 m	1 year
300"	7 350 073 731 961	664 x 374 cm	762.1 cm	Black	Matte white	1,0	7 cm	95 kg	2,91 x 1,82 m	1 year

M Quick Fold
Projection Screen 16:10
120" to 180"

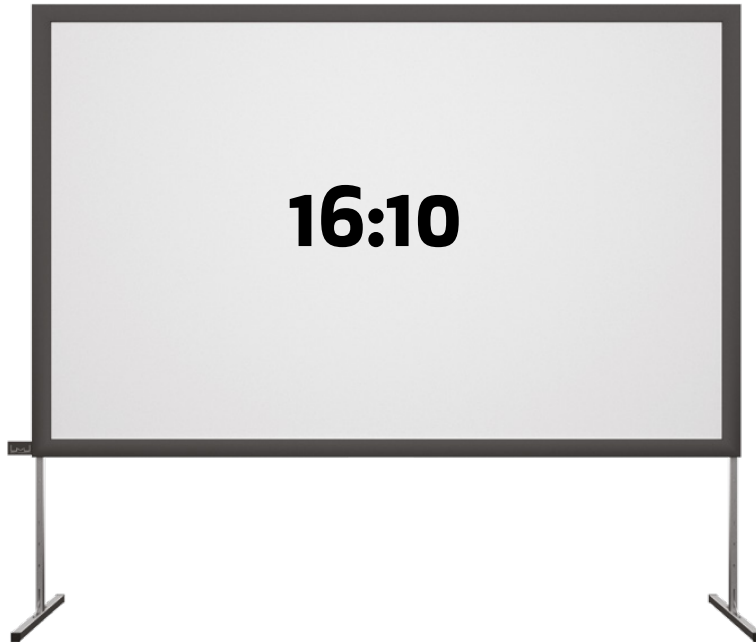

Size:	Article Nr:	Projection Area:	Diagonal	Frame colour:	Surface:	Gain:	Frame:	Wieght:	Single package measurements:	Warranty:
120"	7 350 073 731 978	258 x 161 cm	304.1 cm	Black	Matte white	1,0	7 cm	26 kg	116 x 34 x 34 cm	1 year
150"	7 350 073 731 985	323 x 202 cm	380.9 cm	Black	Matte white	1,0	7 cm	31 kg	138 x 37 x 37 cm	1 year
180"	7 350 073 731 992	388 x 242 cm	457.3 cm	Black	Matte white	1,0	7 cm	47 kg	106 x 42 x 42 cm	1 year

M Quick Fold
Projection Screen 16:10
200" to 300"

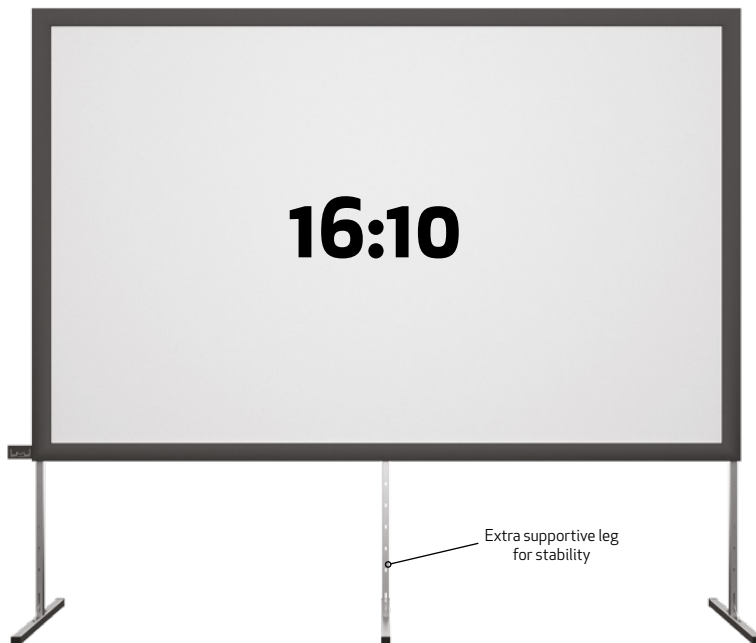

Size:	Article Nr:	Projection Area:	Diagonal	Frame colour:	Surface:	Gain:	Frame:	Wieght:	Single package measurements:	Warranty:
200"	7 350 073 732 005	431 x 269 cm	508.1 cm	Black	Matte white	1,0	7 cm	53 kg	140 x 17 x 17 cm	1 year
250"	7 350 073 732 012	538 x 336 cm	634.3 cm	Black	Matte white	1,0	7 cm	69 kg	138 x 47 x 47 cm	1 year
300"	7 350 073 732 029	646 x 404 cm	761.9 cm	Black	Matte white	1,0	7 cm	100 kg	158 x 44 x 44 cm	1 year

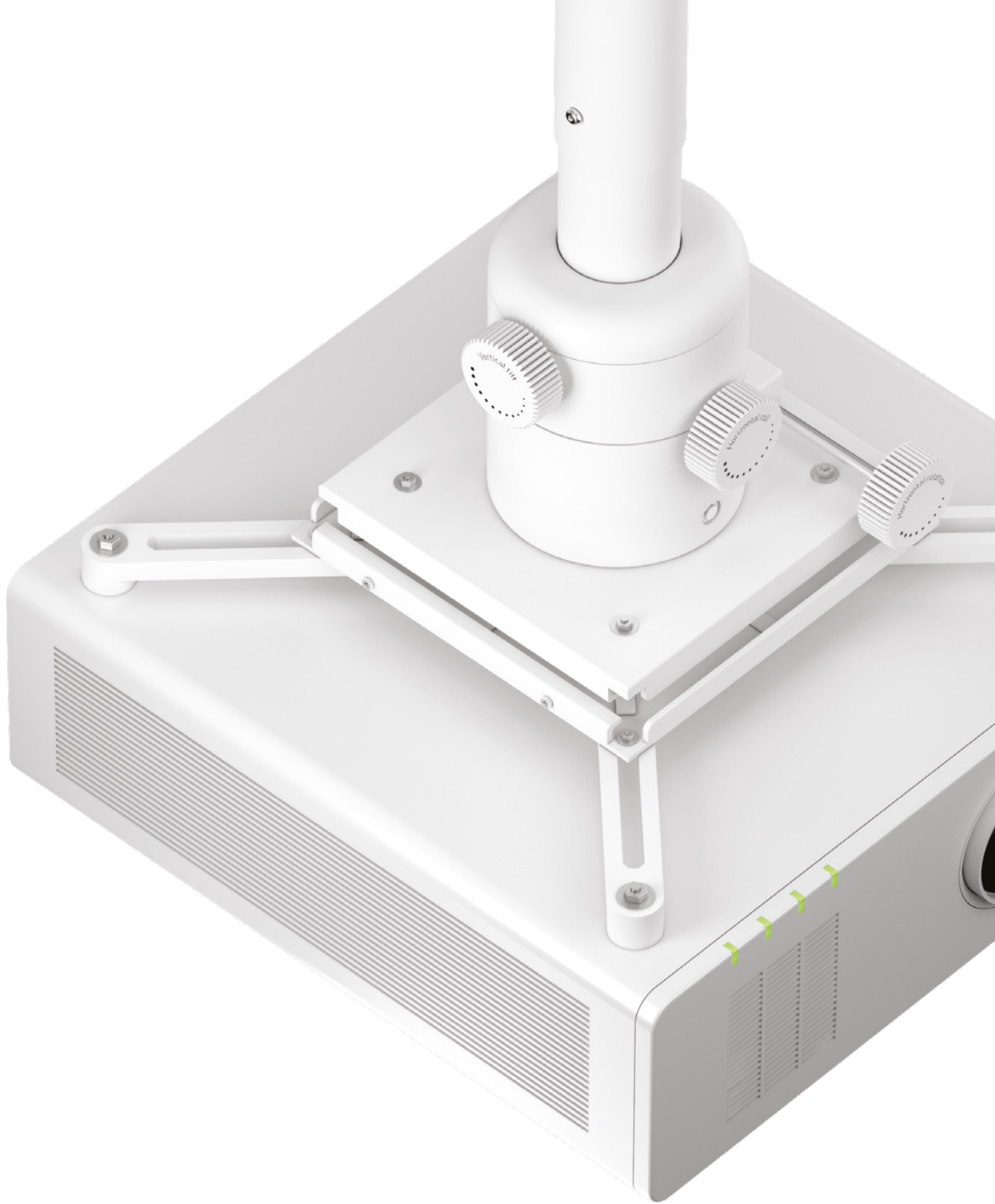

CHOOSE THE RIGHT MOUNT FOR YOUR PROJECTOR:

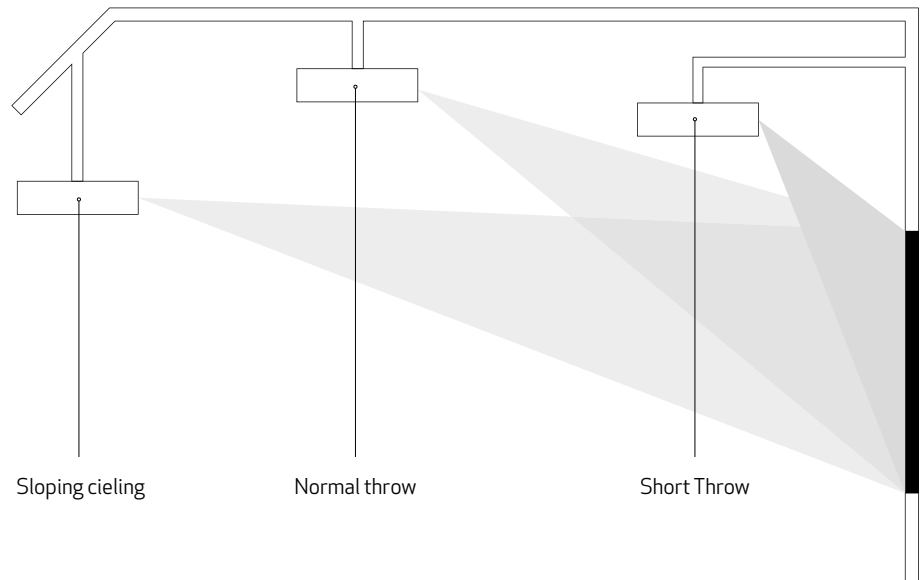

PROJECTOR CEILING MOUNTS

PROJECTOR CEILING MOUNTS

INDUSTRY-LEADING PROJECTOR MOUNTS WITH FINE TUNE TECHNOLOGY FOR CEILING INSTALLATIONS.

Le Screen Projector Ceiling Mount series 200/ 500-800/ 600-1000/ 900-1600/ 1600-3000 with Fine tune offers an industry-leading projector mount for ceiling installations. The series minimizes installation time, simplify maintenance and offers a sought after fine tune adjustment alignment with 3-axle angles. This model also offers an anti-theft security feature.

The M Universal Projector Ceiling Mount 200 with Fine tune give you easy placement of your projector in the most discreet setting possible. You can orient and incline according to several axes. The model features integrated cable management, easy fine tune settings adjustments, once the projector is in place. This projector mount has a minimum of surface area to the projector good for not trapping heat close to your projector thus not cutting your projector lamps lifetime.

The built in fine tune technology provides easy fingertip positioning capabilities which automatically adjusts the projectors position. That way you can always be sure to get a well balanced position for your projector after installing it. This does not only save installation time but also make room for possible changes of what projector is being used or how your projection screen is positioned, perfect if you anticipate changing projectors in the future. The arms holding the projector are articulated and telescopic to adopt to almost all projector models.

Le Screen Projector Ceiling Mount series 200/ 500-800/ 600-1000/ 900-1600/ 1600-3000 with Fine tune offers an industry-leading projector mount for ceiling installations. The series minimizes installation time, simplify maintenance and offers a sought after fine tune adjustment alignment with 3-axle angles. This model also offers an anti-theft security feature.

There is a reason why this series of projector mounts quickly has become one of Le Screen top selling product lines.

HIGHLIGHTS:

- Fast installation with innovative design
- Ideal for those who wish to use it with more than one brand projectors, or who anticipate changing projectors in the future
- Projector position from the ceiling
- Integrated lateral shift
- Telescopic slide extension
- Fine tune adjustment alignment with 3-axle angle
- Integrated cable management system for concealing cables
- Product: Includes arm and projector mount (complete)
- Ceiling: Includes hardware for a complete installation for nearly any ceiling
- For faster installation the unit comes partially pre assembled



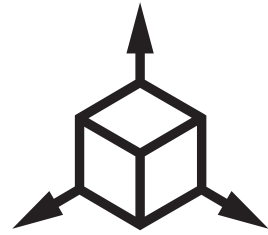
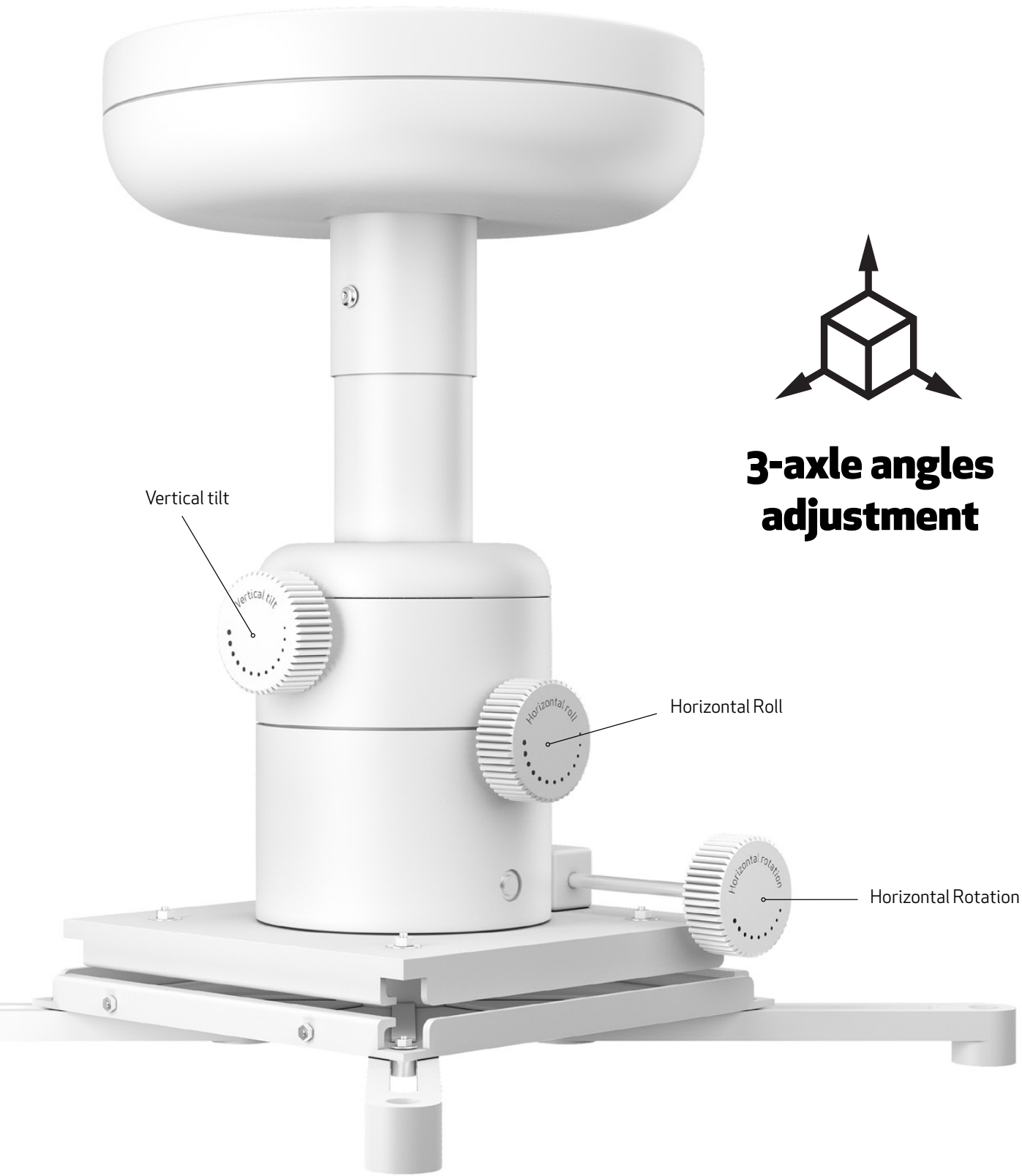

3-axle angles adjustment

Vertical tilt

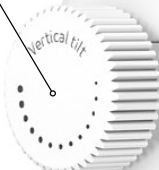

Horizontal Roll

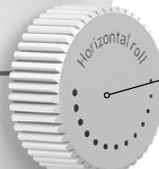

Horizontal Rotation

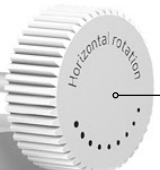

PRO M Universal Projector Ceiling Mount with Fine tune

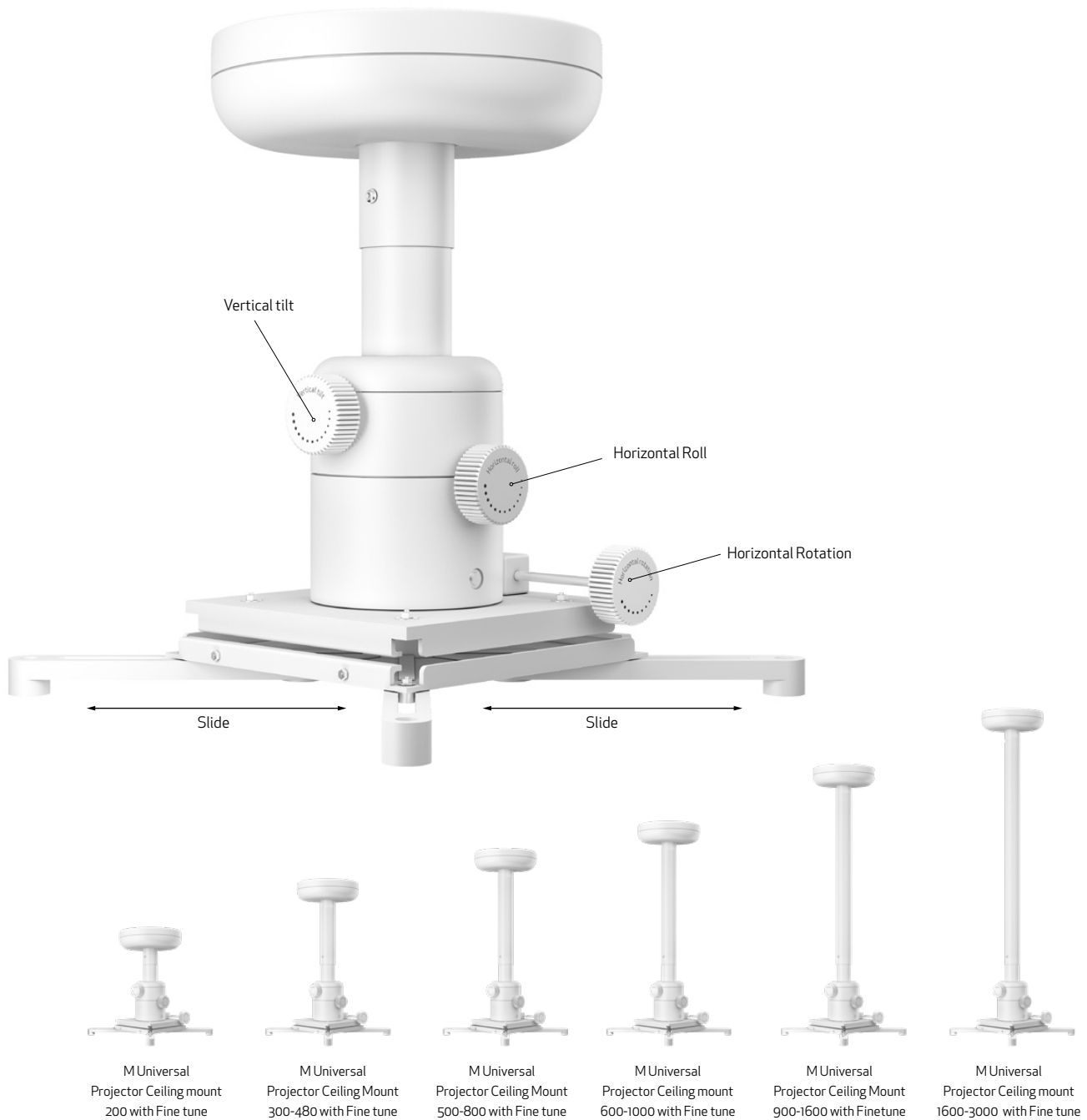

Article No:	7 350 073 730 728	7 350 073 733 149	7 350 073 731 770	7 350 073 730 735	7 350 073 731 787	7 350 073 730 742
Height:	200 mm	300 - 480 mm	500 - 800 mm	600 - 1000 mm	900 - 1600 mm	1600 - 3000 mm
Vertical tilt:	±5°	±5°	±5°	±5°	±5°	±5°
Horizontal roll:	±5°	±5°	±5°	±5°	±5°	±5°
Horizontal rotation:	±5°	±5°	±5°	±5°	±5°	±5°
Dist. from ceiling:	200 mm	300 - 480 mm	500 - 800 mm	600 - 1000 mm	900 - 1600 mm	1600 - 3000 mm
Weight:	2,1kg	2 kg	2.4 kg	2.4 kg	2.4 kg	3.3 kg
Colour:	White	White	White	White	White	White
Max load ceiling / wall:	15 kg	15 kg	10 kg	10 kg	10 kg	10 kg
Warranty:	5 years	5 years	5 years	5 years	5 years	5 years

HEAVY DUTY M Projector Mount HD

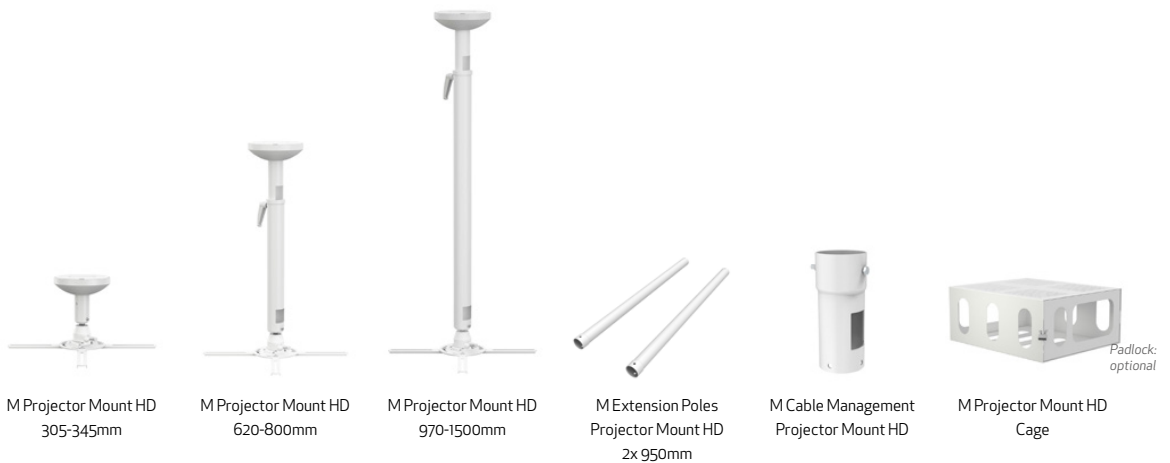

Sloping ceiling mount included

M Projector Mount HD
305-345mmM Projector Mount HD
620-800mmM Projector Mount HD
970-1500mmM Extension Poles
Projector Mount HD
2x 950mmM Cable Management
Projector Mount HDM Projector Mount HD
CagePadlock:
optional

Article No:	7 350 073 735 211	7 350 073 735 228	7 350 073 735 235	7 350 073 735 242	7 350 073 737 383	7 350 073 735 259
Height:	305-345 mm	620-800mm	970-1500 mm	950 mm	125 mm (Diameter: 50/54 mm)	Inner cage size: 482x402x198mm
Dist. from ceiling min.:	305 mm	620 mm	970 mm	-	-	-
Dist. from wall min.:	335mm	650mm	1000mm	-	-	-
Tilt:	+/-20°	+/-20°	+/-20°	-	-	-
Weight:	2 kg	2 kg	2 kg	2 kg	0.1 kg	6.5 kg
Colour:	White	White	White	White	White	White
Max load ceiling / wall:	30 kg	30 kg	30 kg	30 kg	-	30 kg
Rotate:	360°	360°	360°	-	-	-
Warranty:	5 years	5 years	5 years	5 years	5 years	5 years

BASIC M Universal Projector Ceilingmount



M Universal
Projector Ceilingmount I



M Universal
Projector Ceilingmount III
180 or 430mm



M Universal
Projector Ceilingmount IIII
400-1700mm

Article No:	7 350 022 730 311	7 350 022 731 011	7 350 022 732 544
Height:	150 mm or 430-630 mm	180 mm or 430 mm	400-1700 mm
Dist. from ceiling minimum:	150 mm	180 mm	150 mm
Dist. from wall minimum:	-	430 mm	-
Tilt:	Yes	Yes +/-30°	Yes +/-30°
Weight:	2kg	2kg	3kg
Colour:	White	White	White
Max load ceiling / wall:	5kg	10/7,5kg	10 kg
Rotate:	360°	360°	360°
Warranty:	5 years	5 years	5 years

SHORT THROW M Projector Mount Short Throw Deluxe

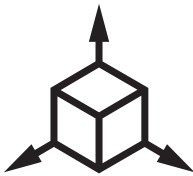
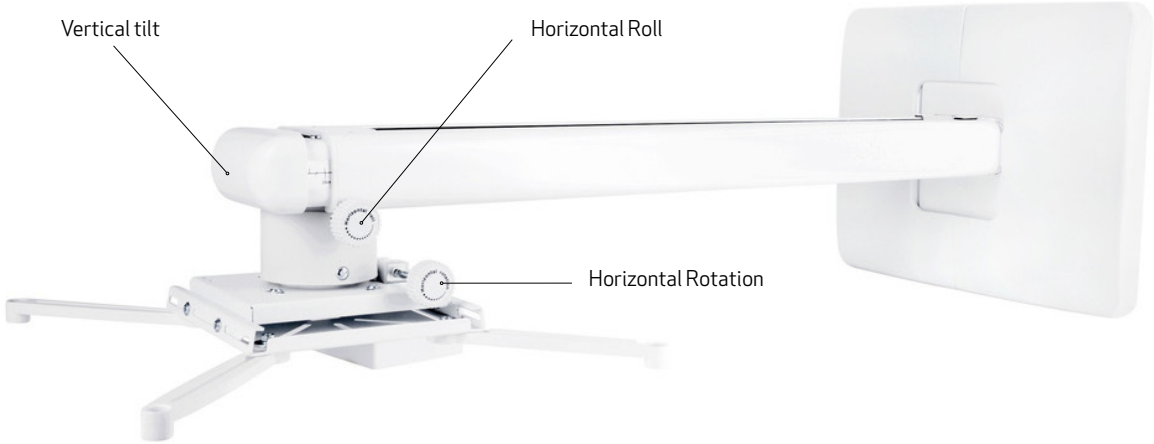

**3-axe
adjustment**

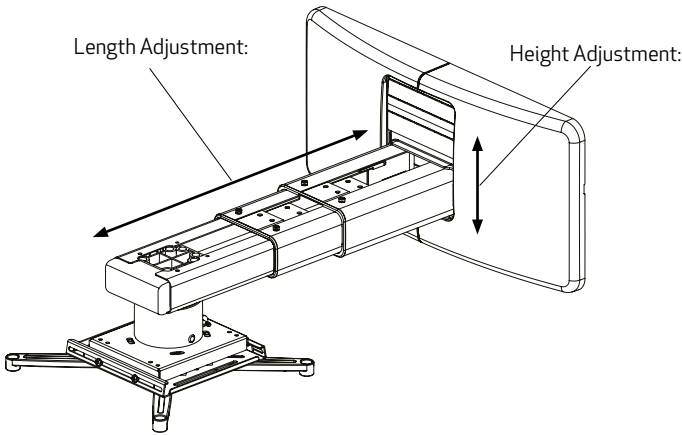

M Projector Mount
Short Throw Deluxe
600-1300 Large



M Universal
Projector Ceiling Mount
500-800 with Fine tune

Article No:	7 350 073 730 339	7 350 022 739 833
Length Adj.:	600 - 1300 mm	325 - 740 mm
Size:	723x210x325 mm	448x210x325 mm
Weight:	3 kg	3 kg
Colour:	White	White
Max load ceiling / wall:	25 kg	25 kg
Warranty:	5 years	5 years



"Everything starts with you.

For us to create great products it always begins with putting you the user at the heart of everything we do."

Mission

We are on a mission to create products that are simple to install and use, that excites and solves our clients daily needs - everyday, all year around. Based in Stockholm, Sweden we design, develop and market AV Equipment. But we do it our way. Armed with a genuine passion for new technology and user centric innovation, we take a product and give it a little bit of Multibrackets magic!

About us

Founded in year 2000 we are a family owned business and represented in over 30 countries. Today we are considered one of the leaders in the rapidly changing environment of digital signage technology – together with our distributors we are providing hardware and services to enable the full value from idea to a ready product. With one of the most comprehensive product lines in EU we supply Audio Visual Equipment for every need. Multibrackets reputation for innovative products is well known.

Become a partner

Stay ahead of your competition – Let us help you become a partner. Simply send us an email on support@multibrackets.com or go to our webpage <https://products.multibrackets.com/en/contact> for a contact with us at Multibrackets and we will help you with a distributor's contact. We look forward to your email.

Contact details

Multibrackets Europe AB
Döbelnsgatan 21, 11th floor
SE-111 40 Stockholm
SWEDEN

Reach us on email support@multibrackets.com or phone +46 (0)8 - 615 04 00

Sustainability

At Multibrackets we see sustainability like a journey. Being in the AV business means we have a responsibility to take care of the environment and everybody who plays a part in making our products. We are working hard to design sustainable products, minimize our impact on the environment, improve our sourcing and create a great workplace for our employees. Find out more about what we are doing and what we've already achieved on our web.

Copyright

This catalogue is protected by copyright laws. The graphic design, content, and images in this catalogue may not be reproduced, published displayed, or reproduced in any way, in whole or in part. This catalogue is considered the intellectual property of Multibrackets Europe AB, and we respectfully ask that you not copy, transmit, distribute, or create a derivative work based upon the content and materials of this catalogue. The content is also subject to the copyright laws of EU and the US (Act of 1976, Title 17 of the United States Code) and may not be copied for use in your publications or newsletters without prior written consent of Multibrackets Europe AB. If you are a customer of Multibrackets Europe AB and would like permission to use one of our articles in your company publication, please email and we would be happy to consider giving you permission to do so, as long as you would be willing to credit your source (Multibrackets Europe AB).

We reserve ourselves for printing errors

Printing errors. While we strive to display all our information as correct as possible, there sometimes occurs misprinting's and faulty information in catalogues. If this happens, and it should affect in any way the forms of, for example faulty product information, or the alike, we will inform you as soon as we notice, and amend it. Please note that we reserve ourselves the right to cancel any order that has been sold presented with a misprinted information. Editing, deleting, or modification of this catalogue: We reserve the right, for any reason, to edit this catalogue. That means, without advance notice, we may suspend, discontinue, edit, or delete current information, products, services, or any other content appearing in this catalogue.

Again, Welcome to Multibrackets Europe, one of the leading manufacturers of Audio Visual Equipment in Europe.

le Screen[®]

BY MULTIBRACKETS

Multibrackets Europe AB

Phone: +46(0)8- 615 04 00 Mail: support@multibrackets.com

Postaddress: Döbelnsgatan 21, 11th floor SE-111 40 Stockholm Sweden

