



R-Go Split Armrest

RGOARMSP

English manual	p.2
Deutsche Anleitung	p.9
Manuel en français	p.16
Nederlandse handleiding	p.23
Polski podręcznik	p.30
Manual en español	p.37
Manual de português	p.44
Manuale italiano	p.51



ergonomic split armrest

R-Go Split Armrest

Ergonomische geteilte Armlehne

Accoudoir ergonomique divisé

Product overview

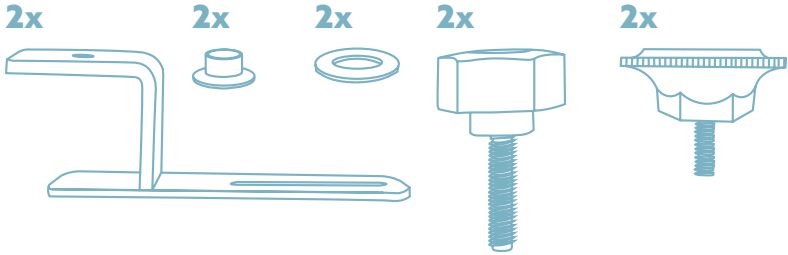
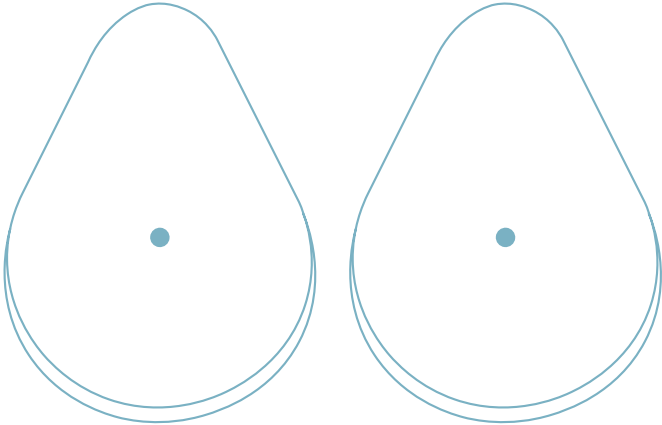

Setup

Step A

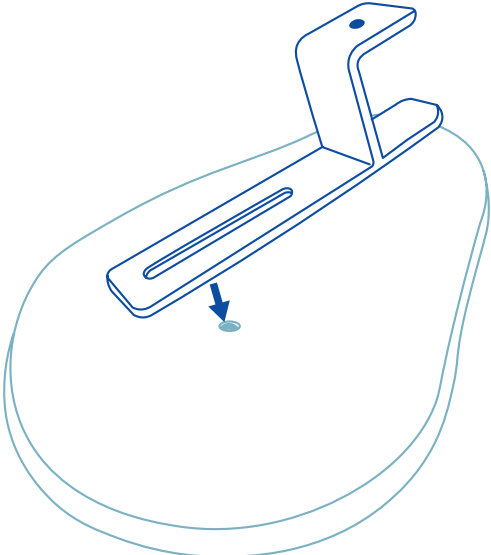

Step B

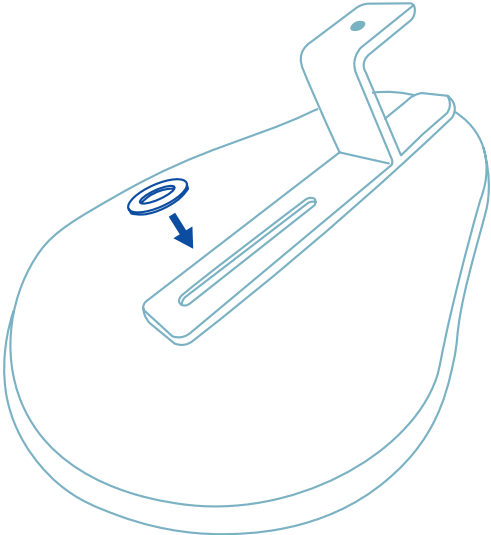

Setup

Step C

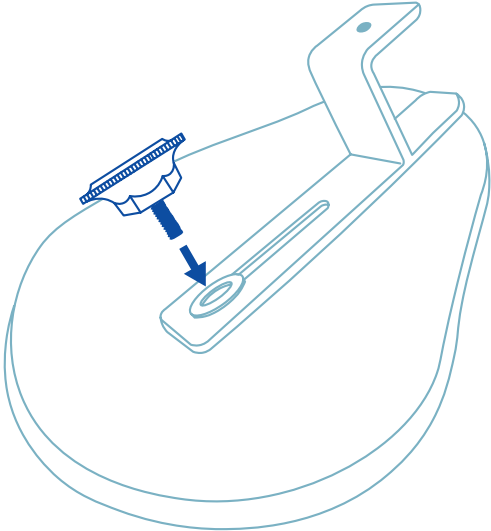

Step D

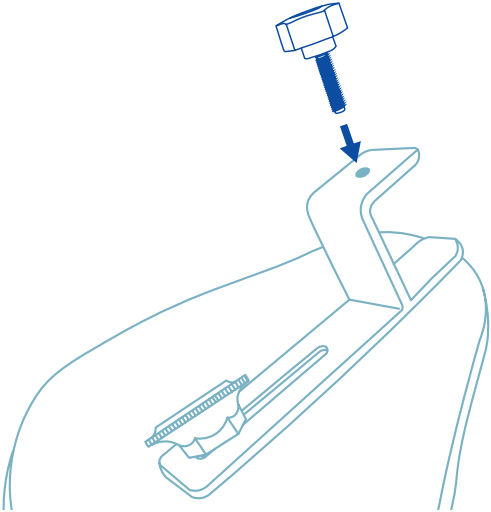

Setup

Step E

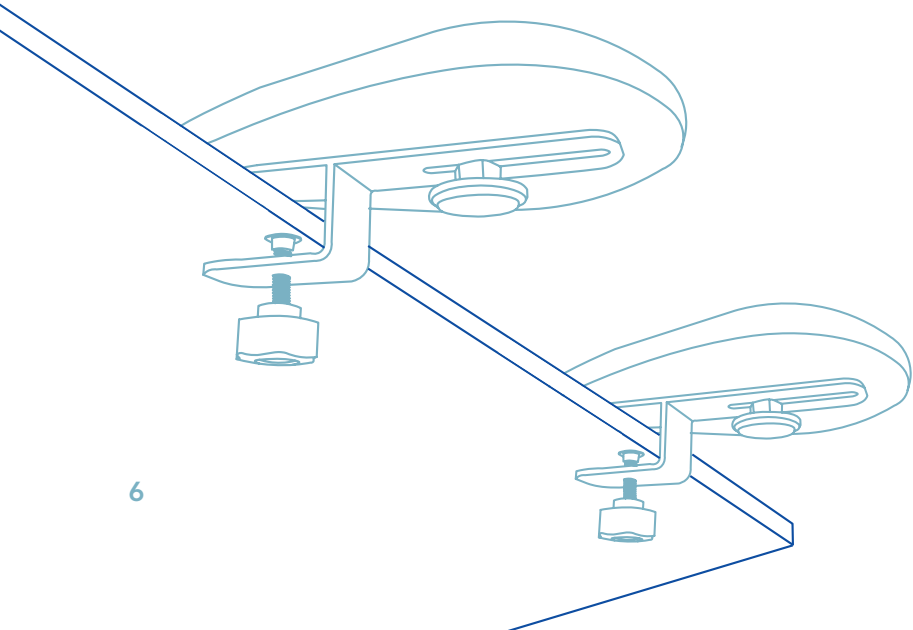
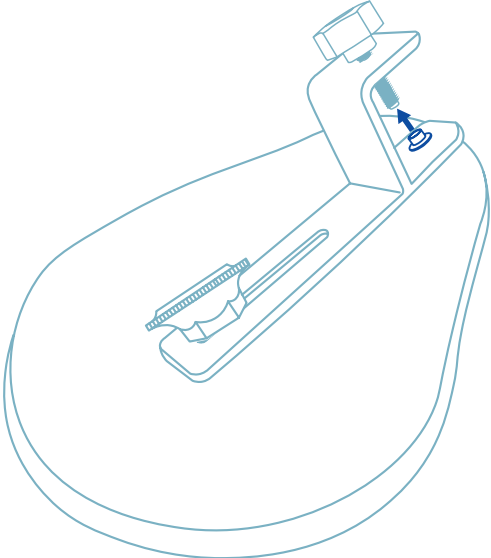

Final product

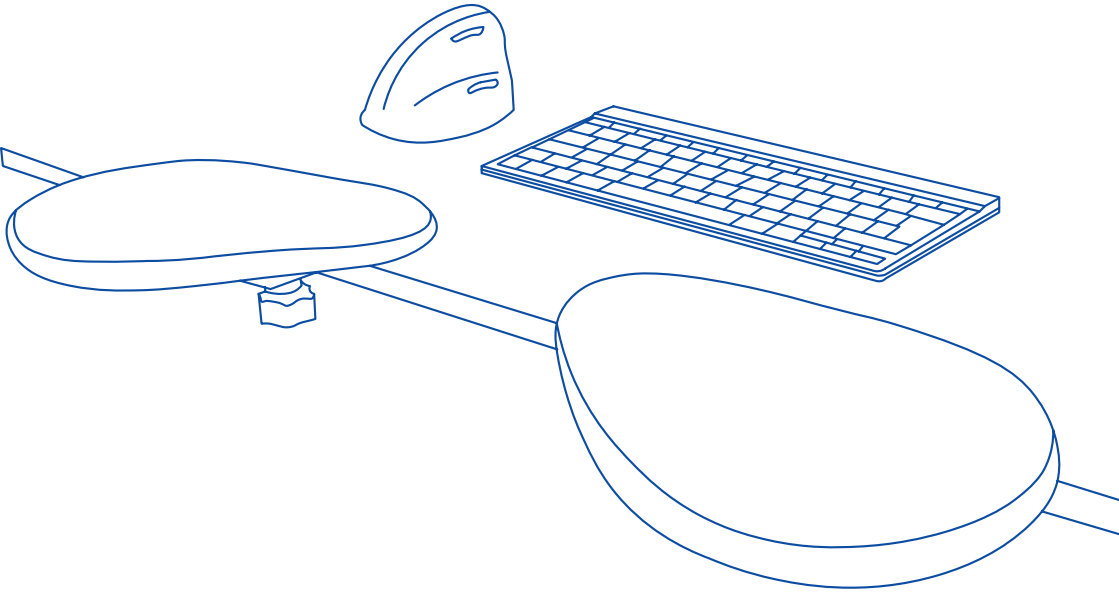

For more information
about this product,
scan the QR code!
https://r-go.tools/arm_web_en

Check if it fits!

Fits all desks that comply with the European guidelines.

Please note, the armrest does not fit the following type of tabletops:

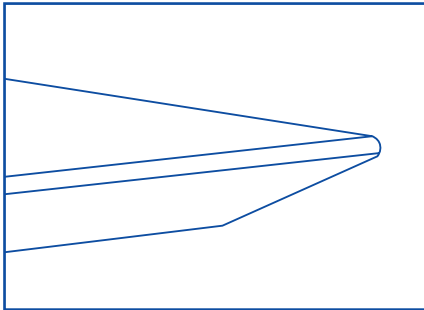

The table top has a **sloping edge**.

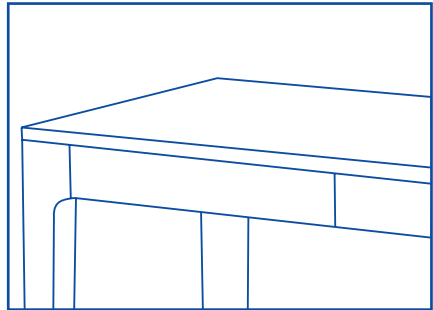

The table has **drawers**.

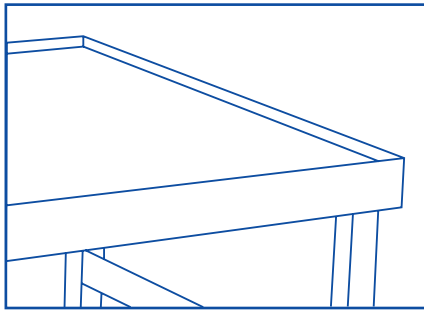

The edge of the table top **is raised**.

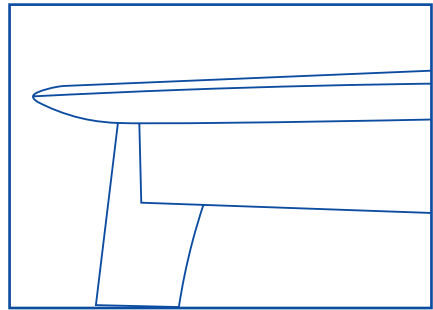

Protruding table top is **smaller than 2.0 inch (50 mm)**.



Ergonomische geteilte Armlehne

R-Go Split Armlehne

Ergonomic split armrest

Accoudoir ergonomique divisé

Produktübersicht

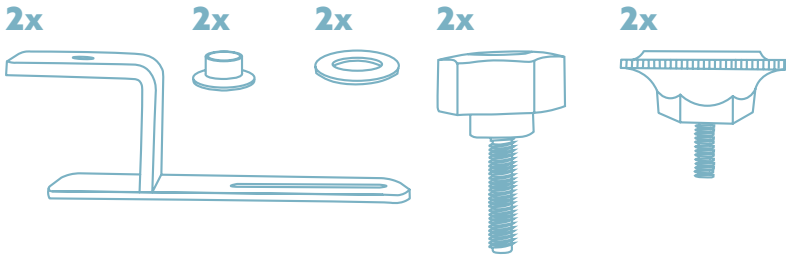
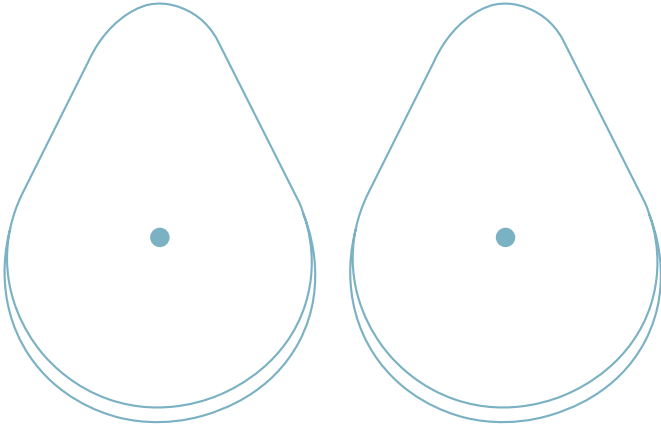

Einrichtung

Schritt A

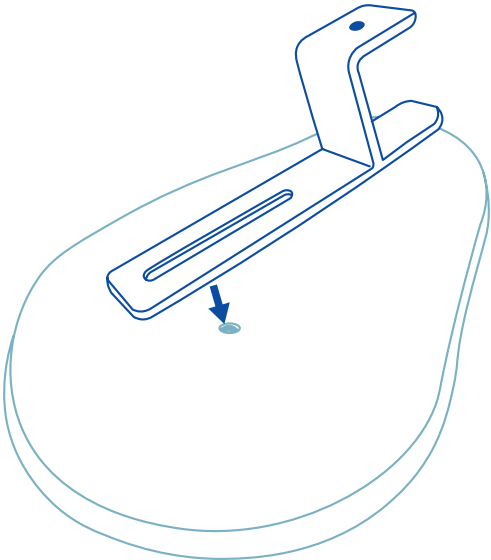

Schritt B

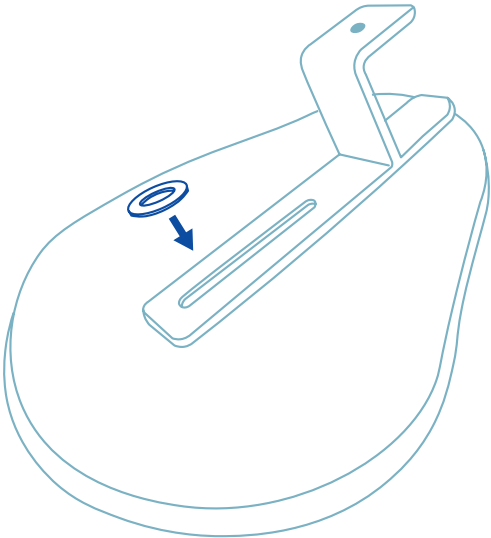

Einrichtung

Schritt C

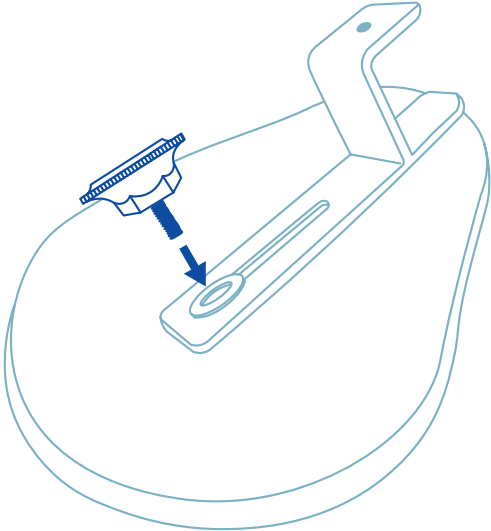

Schritt D

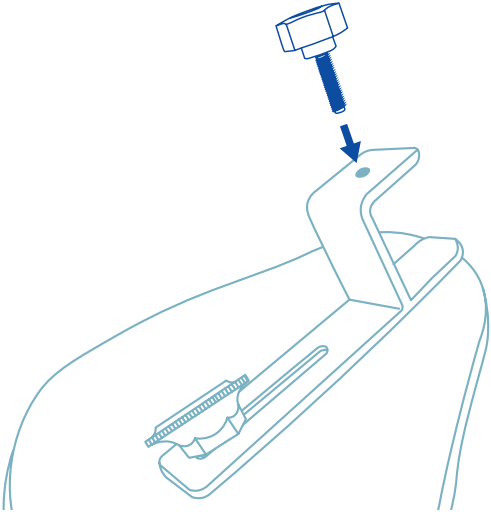

Einrichtung

Schritt E

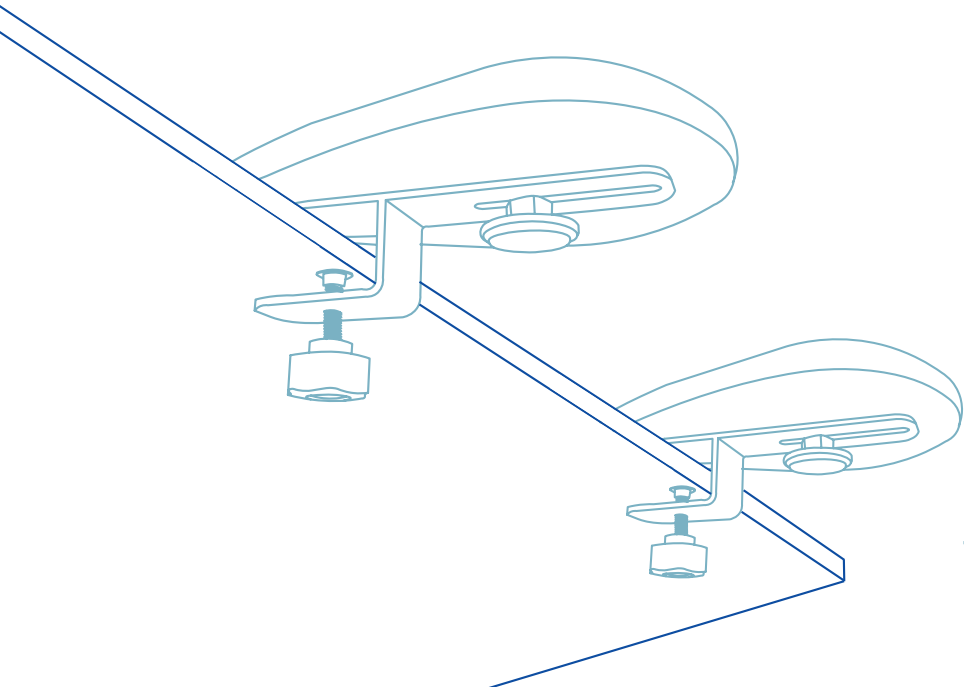
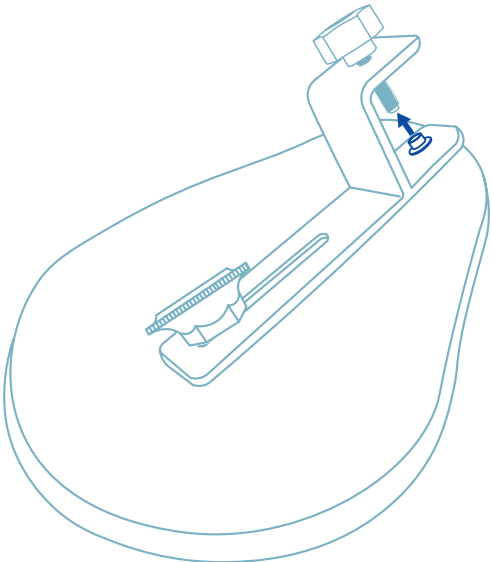

Endergebnis

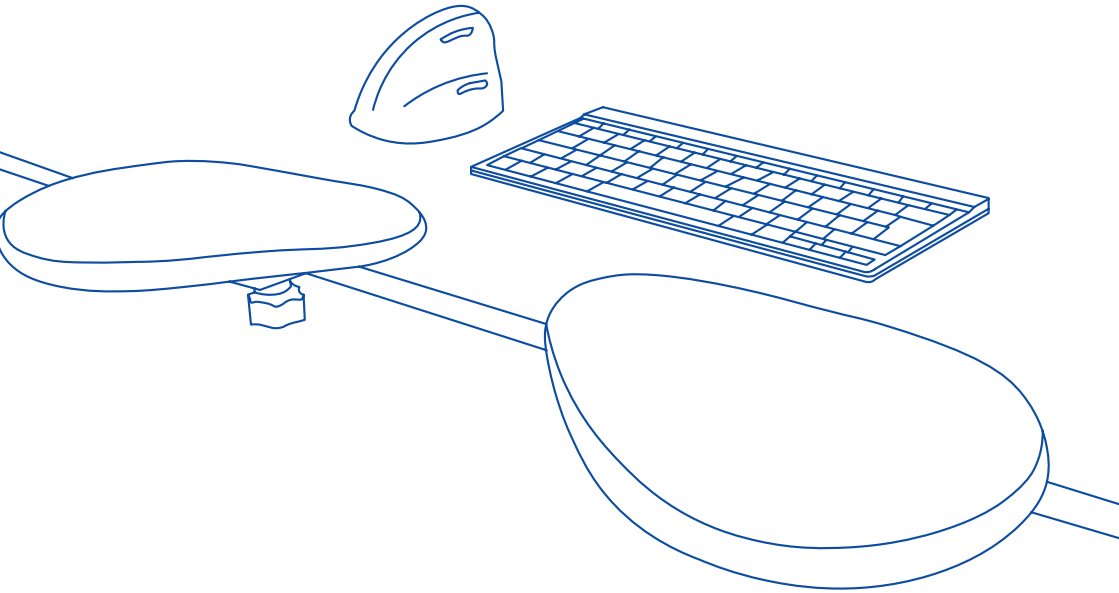

Für weitere Informationen
über dieses Produkt,
scannen Sie den QR-Code!
https://r-go.tools/arm_web_de

Testen Sie, ob sie passt!

Passt auf alle Schreibtische, die den europäischen Richtlinien entsprechen.

Bitte beachten Sie, dass die Armlehne nicht für die folgenden Tischplatten geeignet ist:

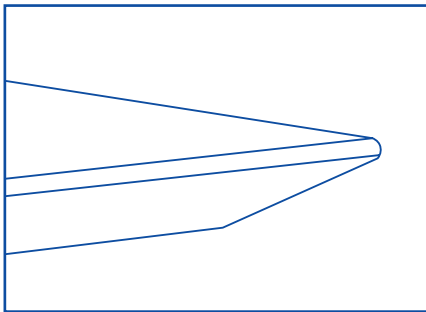

Die Tischplatte hat eine **schräge Kante**.

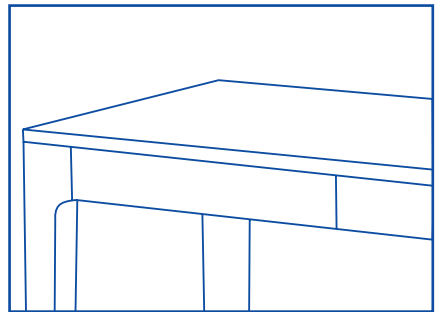

Der Tisch hat **Schubladen**.

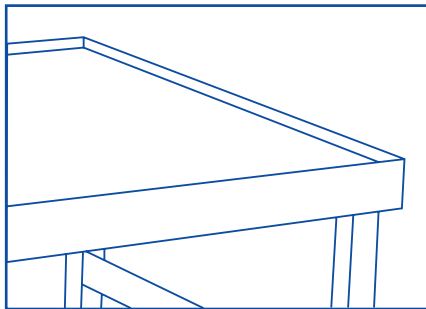

Die Kante der Tischplatte **ist erhöht**.

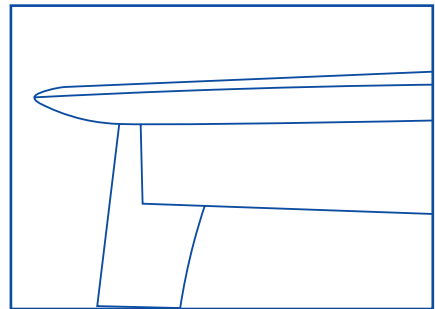

Der Überstand der Tischplatte beträgt **weniger als 50 mm**.



Accoudoir ergonomique divisé

Accoudoir R-Go Split

Ergonomische geteilte Armlehne

Ergonomic split armrest

Vue d'ensemble des produits

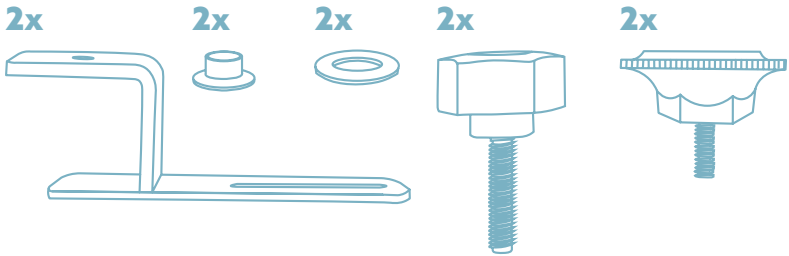
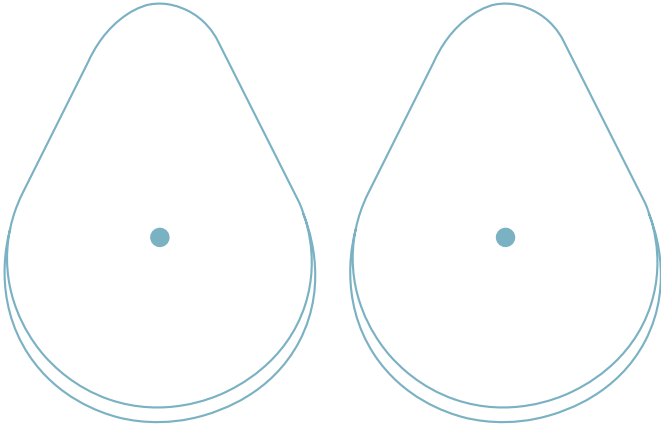

Mise en place

Etape A

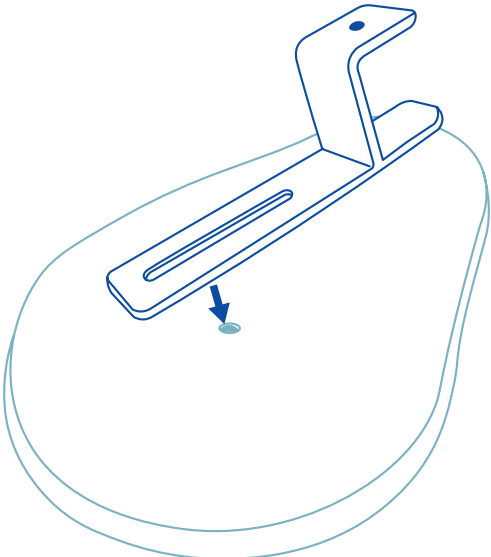

Etape B

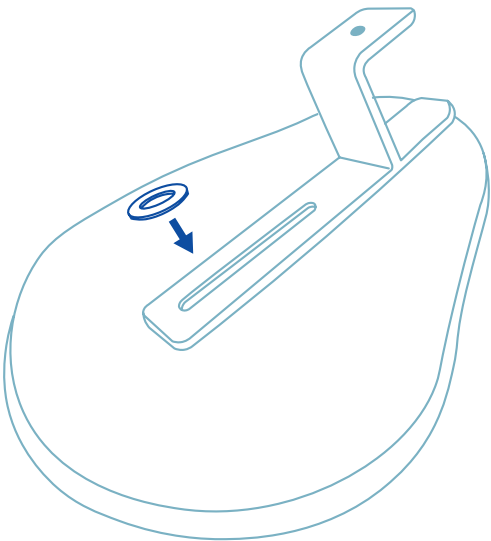

Mise en place

Etape C

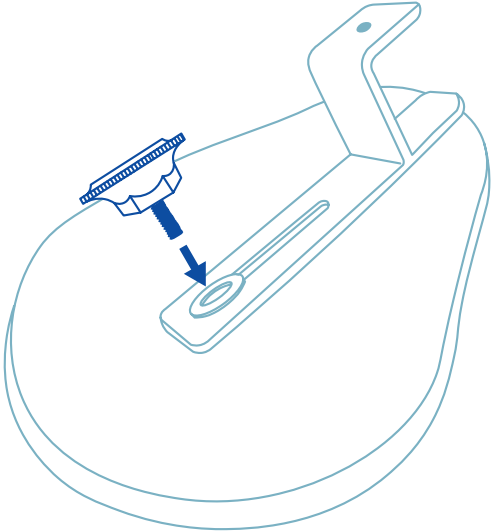

Etape D

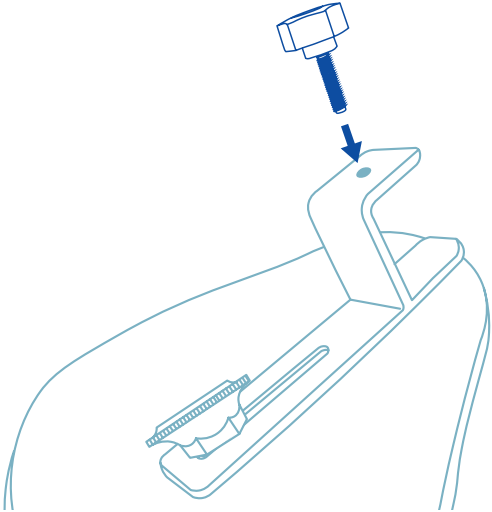

Mise en place

Etape E

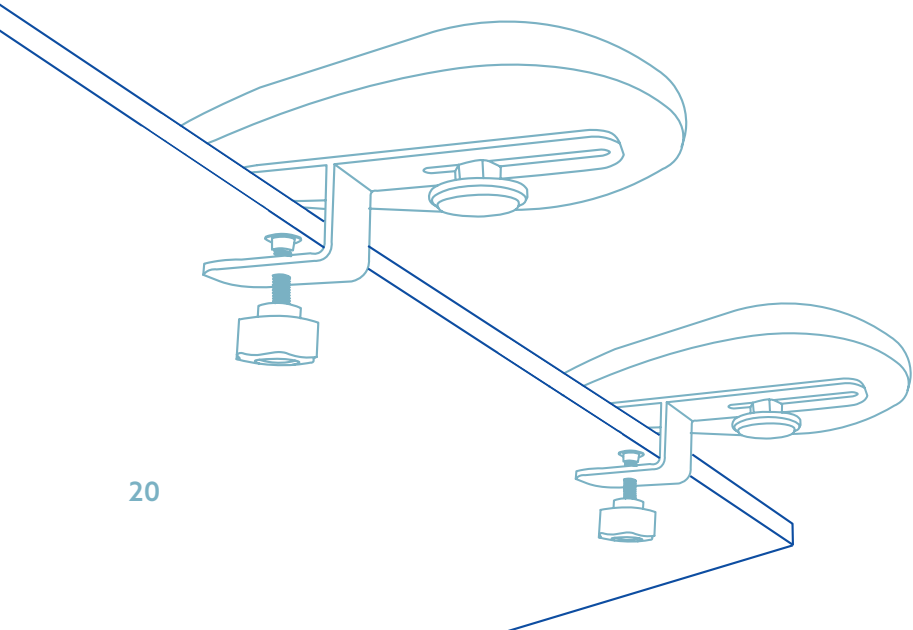
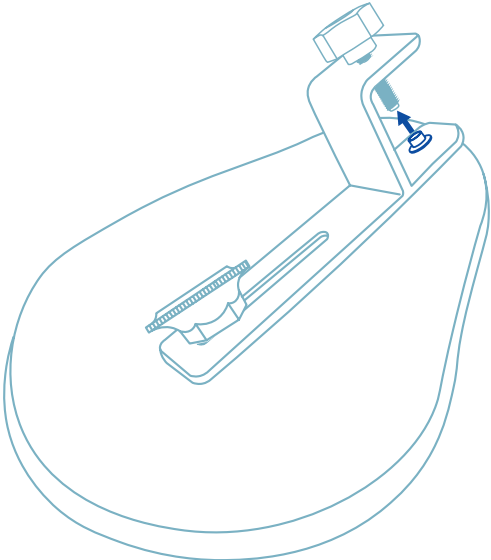

Produit final

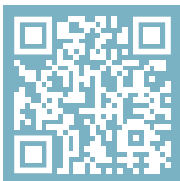
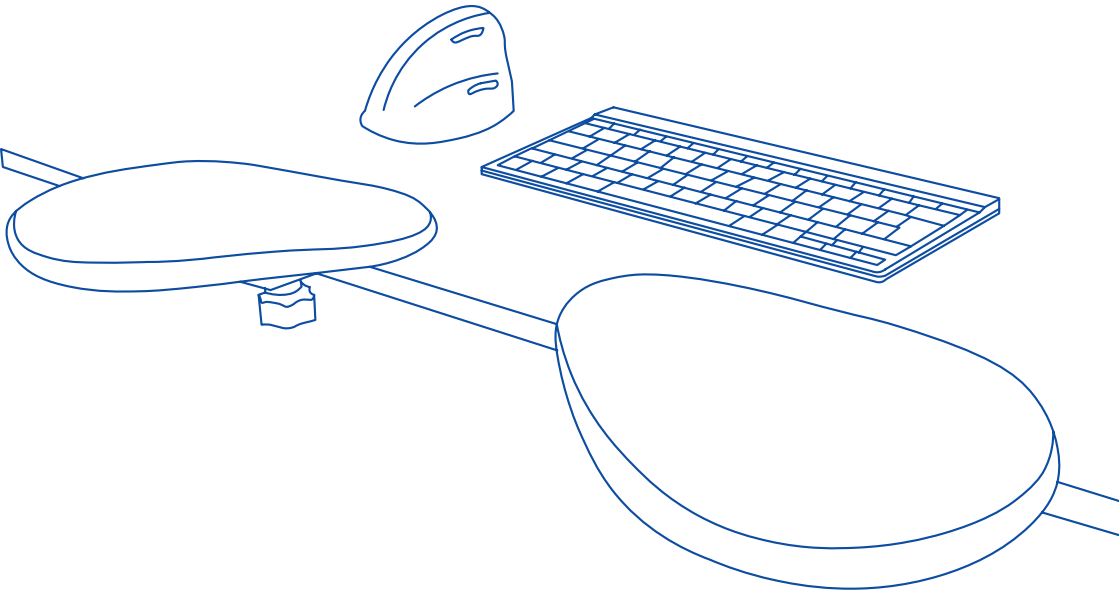

Pour plus d'informations
sur ce produit,
scannez le code QR!
https://r-go.tools/arm_web_fr

Vérifiez qu'elle s'adapte !

Convient à tous les bureaux conformes aux directives européennes.

Veillez noter que l'accoudoir ne convient pas aux types de plateaux de table suivants :

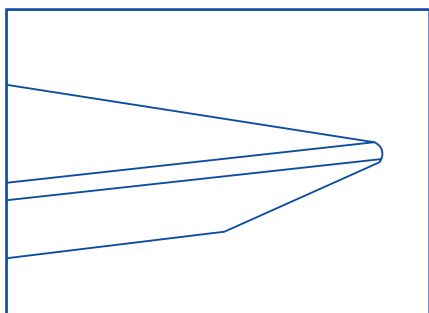

La table a un **bord incliné**.

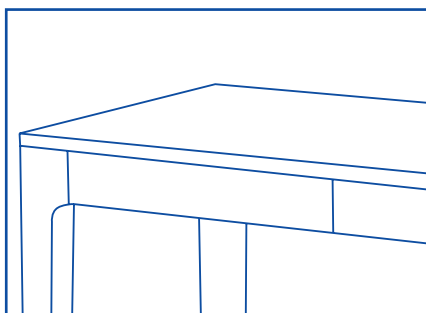

La table a **des tiroirs**.

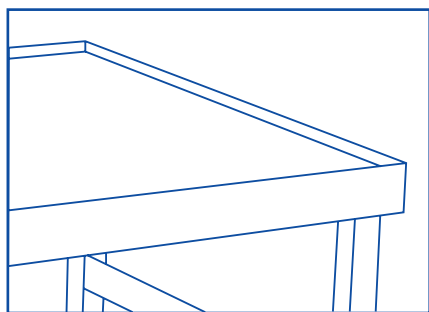

Le bord du plateau est **surélevé**.

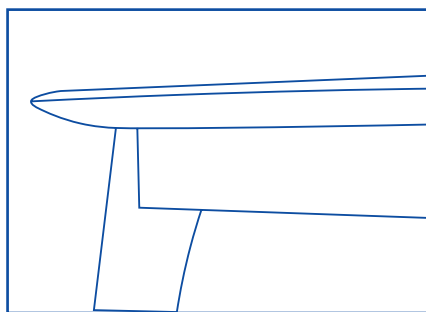

La saillie du plateau de la table est **inférieure à 50 mm**.



ergonomische gesplitste armsteun

R-Go Split Armrest

Ergonomische geteilte Armlehne

Accoudoir ergonomique divisé

Productoverzicht

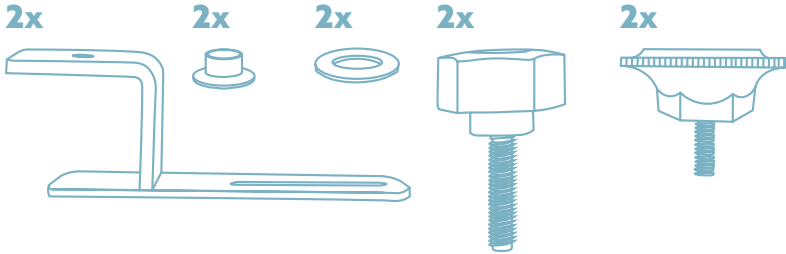
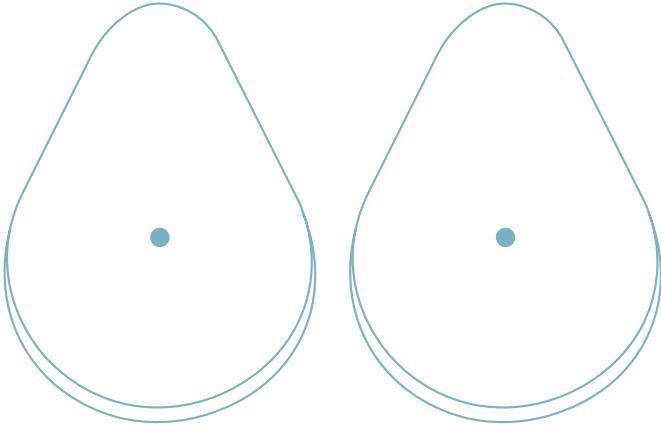

Setup

Step A

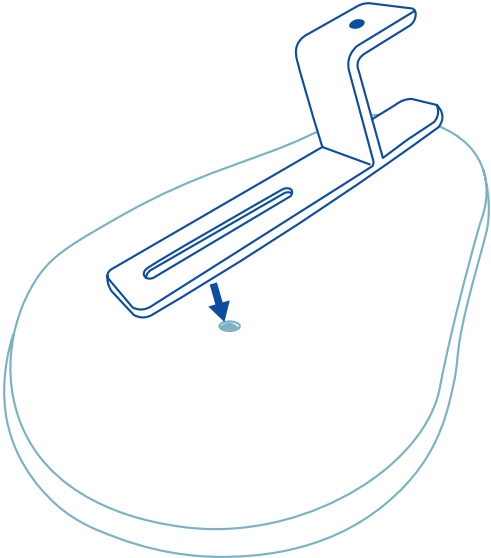

Step B

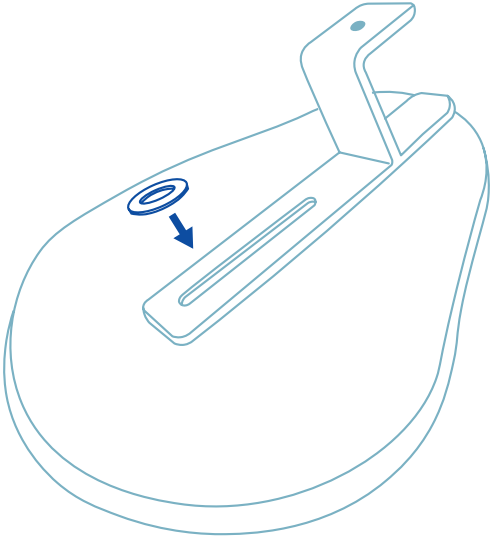

Setup

Step C

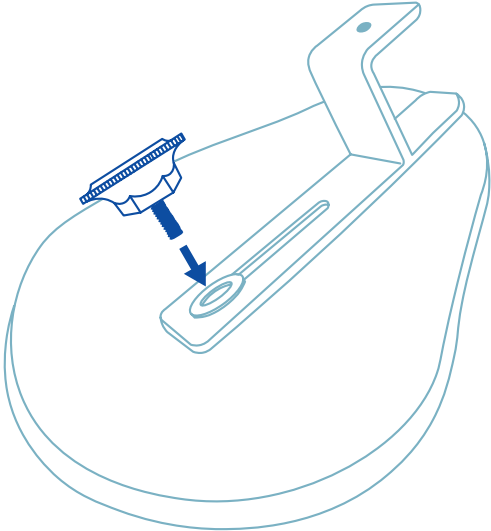

Step D

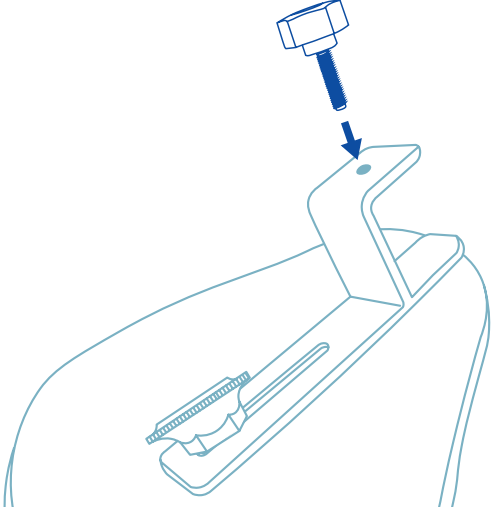

Setup

Step E

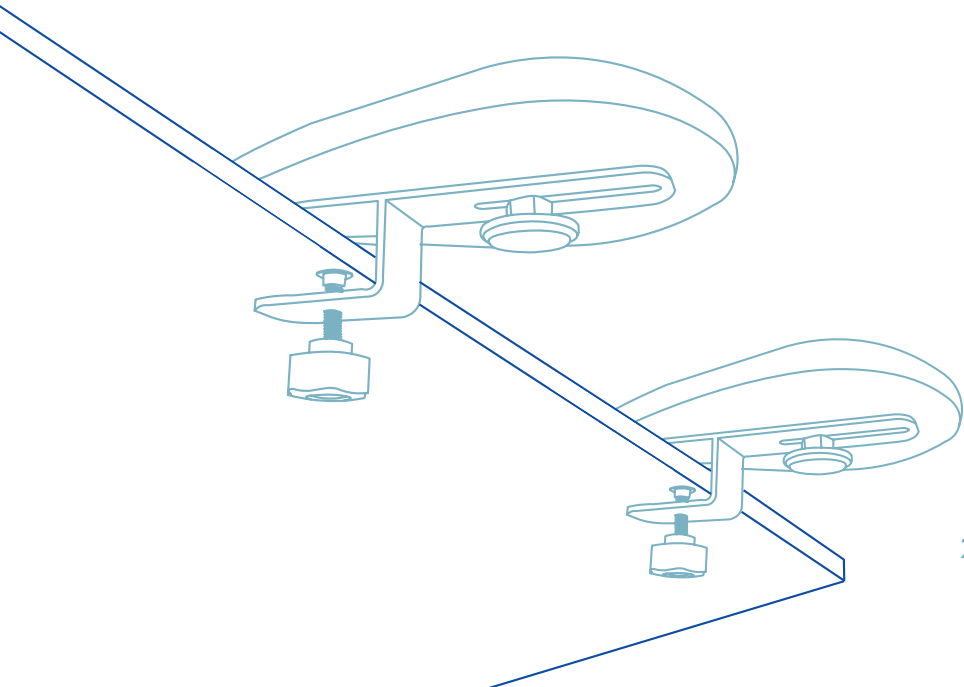
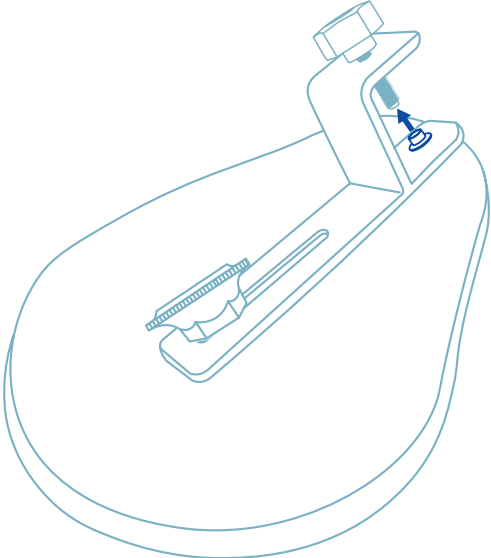

Eindproduct

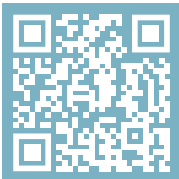
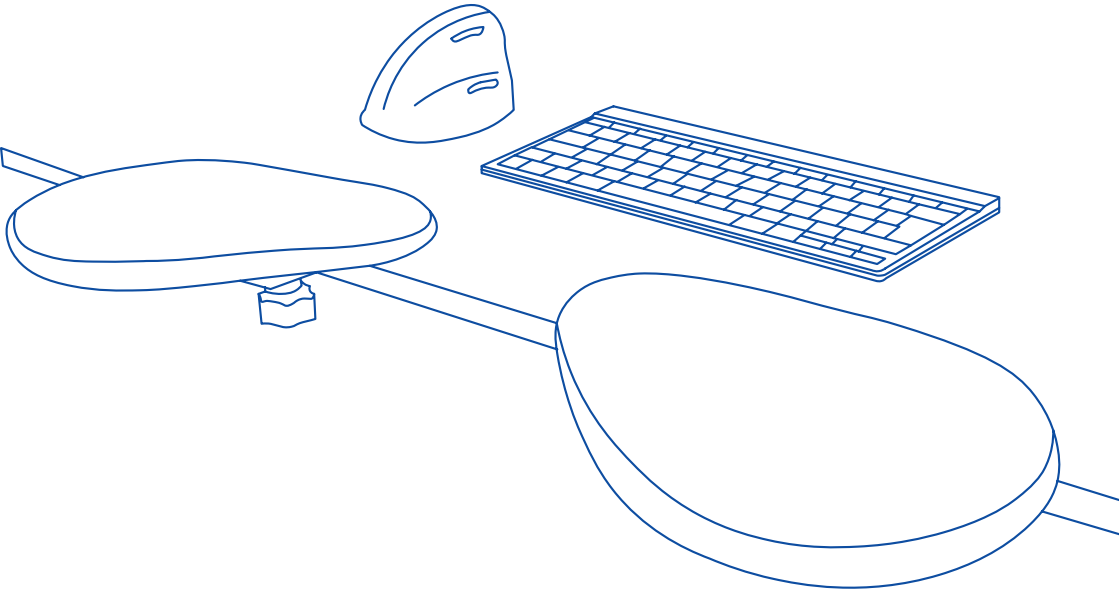

Scan de QR-code voor
meer informatie over
dit product!
https://r-go.tools/arm_web_nl

Controleer of het past!

Past op alle bureaus die voldoen aan de Europese richtlijnen.

Let op, de armleuning past niet op de volgende type tafelbladen:

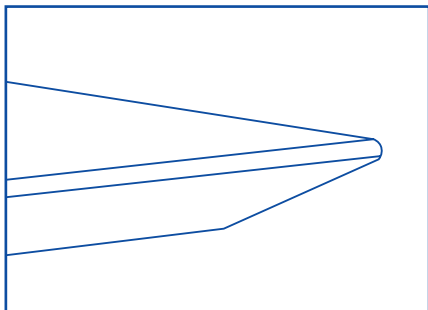

De tafel heeft een **schuine rand**.

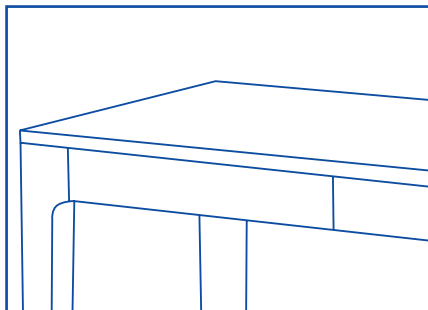

De tafel heeft **laden**.

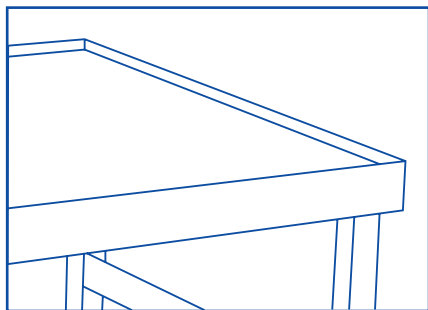

De rand van het tafelblad is **is verhoogd**.

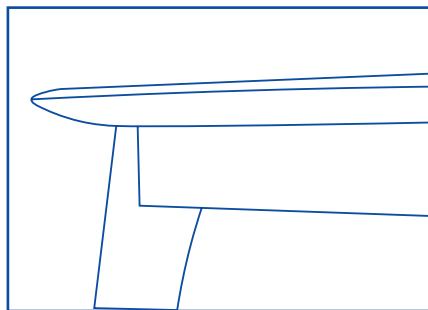

Het uitstekende tafelblad is **kleiner dan 50 mm**.



ergonomiczny dzielony podłokietnik

R-Go Split Podłokietnik

Ergonomische geteilte Armlehne

Accoudoir ergonomique divisé

Przegląd produktu

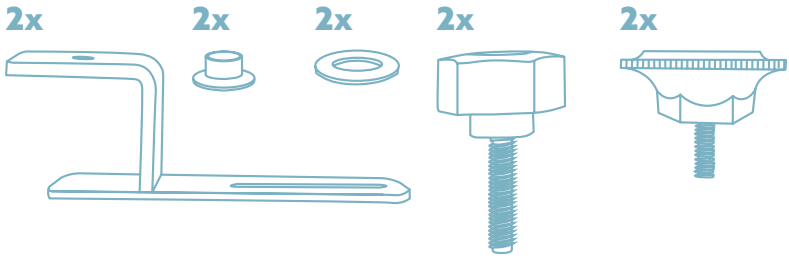
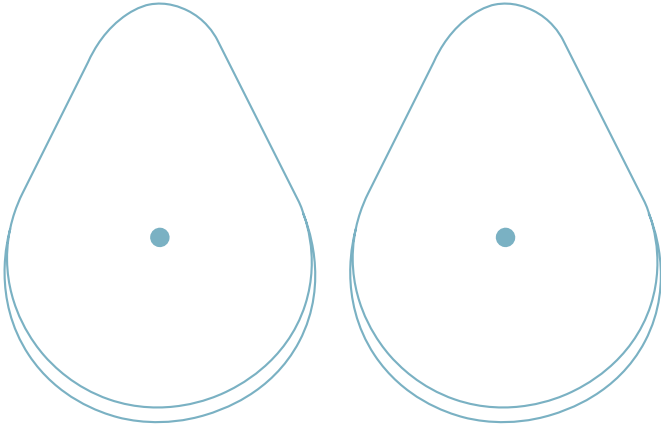

Instalacja

Krok A

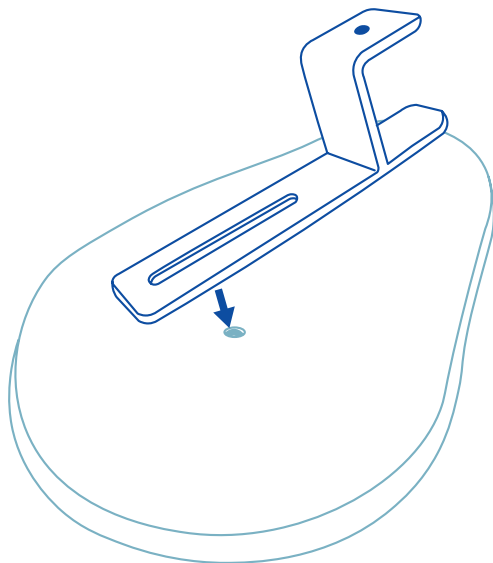

Krok B

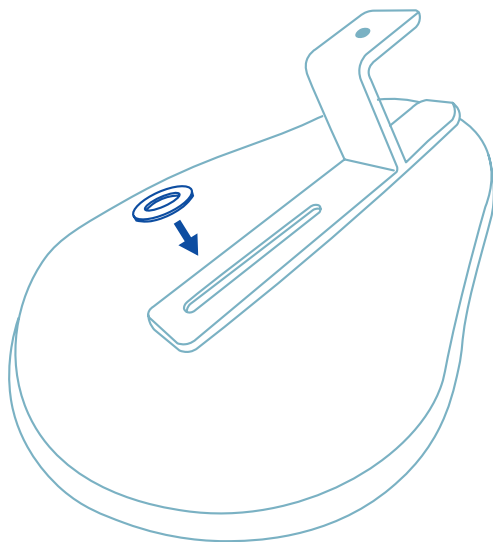

Instalacja

Krok C

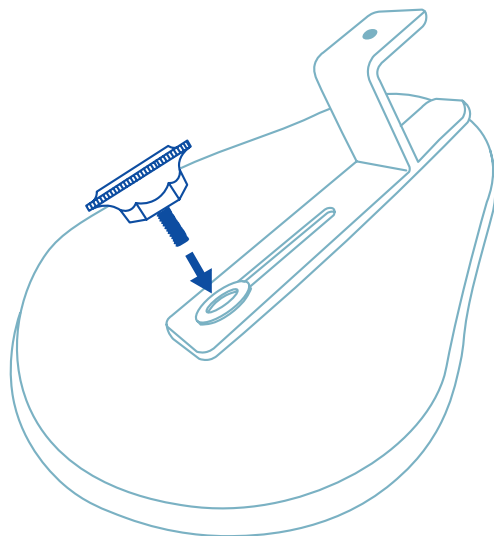

Krok D

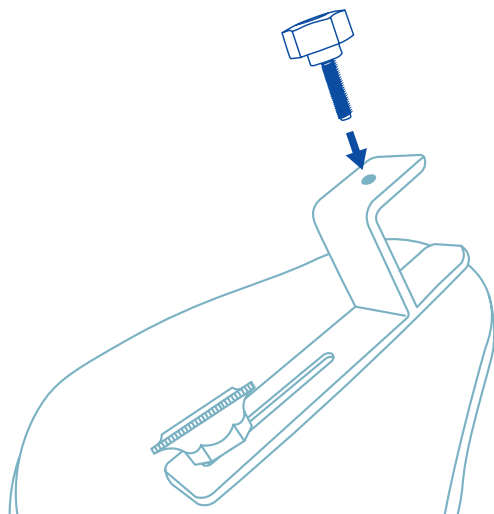

Instalacja

Krok E

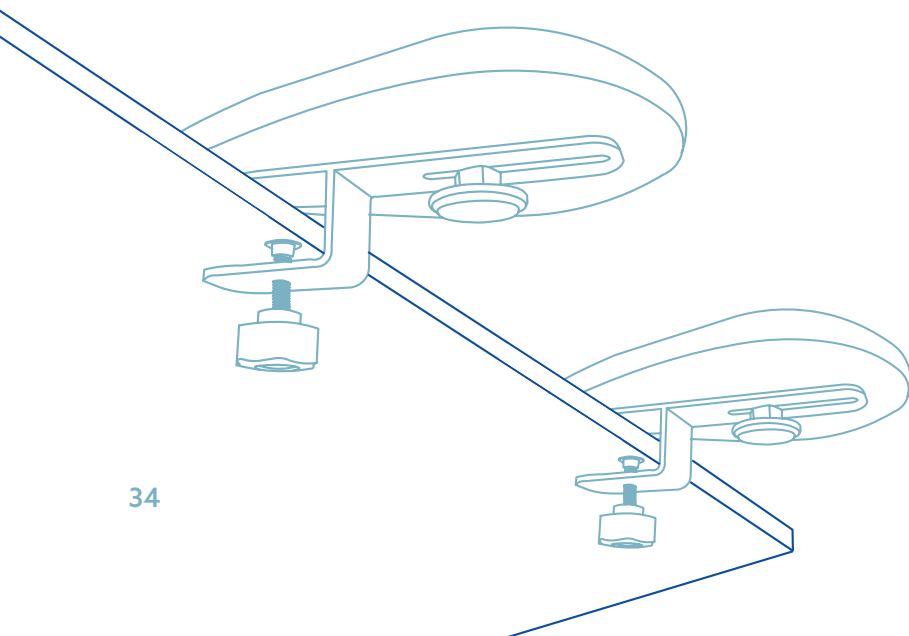
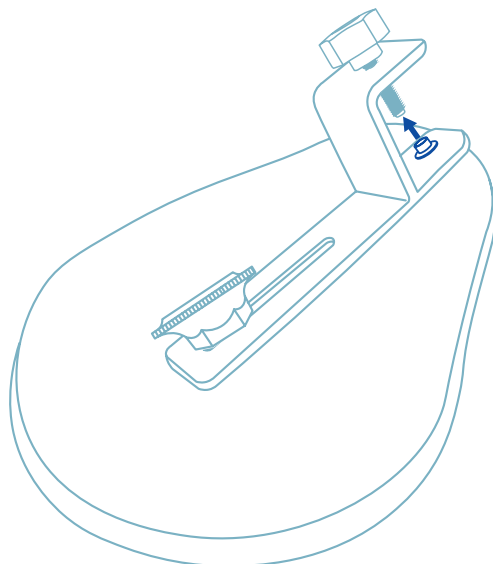

Produkt końcowy

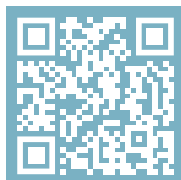
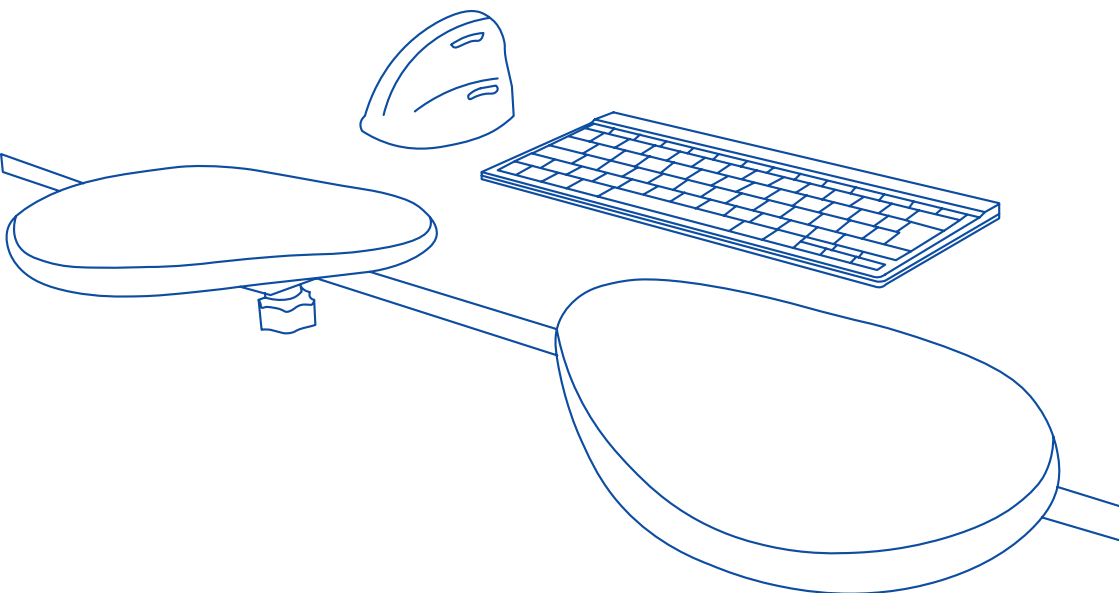

Aby uzyskać więcej informacji o tym produkcie, zeskanuj kod QR!
https://r-go.tools/arm_web_en

Sprawdź, czy pasuje!

Pasuje do wszystkich biurek zgodnych z europejskimi wytycznymi.

Pamiętaj, że podłokietnik nie pasuje do następujących typów blatów:

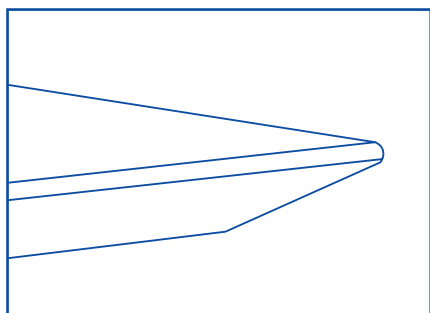

Blat stołu ma **pochyłą krawędź**.

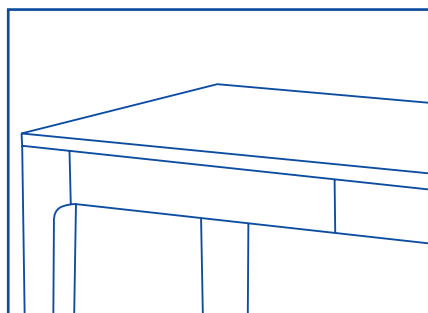

Stół posiada **szuflady**.

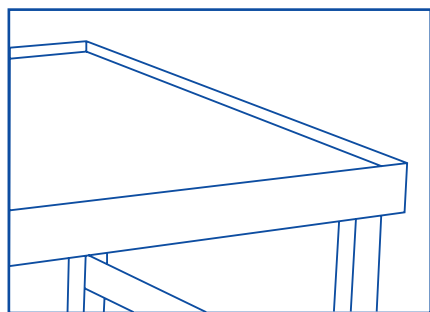

Krawędź blatu jest **podniesiona**.

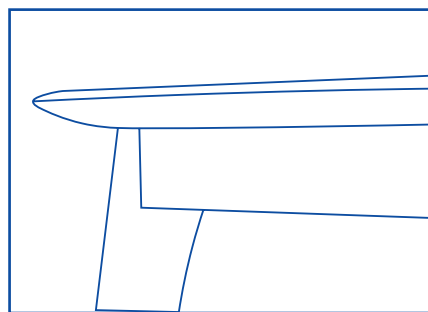

Wystający blat stołu jest **mniejszy niż 50 mm**.



reposabrazos ergonómico dividido

Reposabrazos R-Go Split

Ergonomische geteilte Armlehne

Accoudoir ergonomique divisé

Resumen del producto

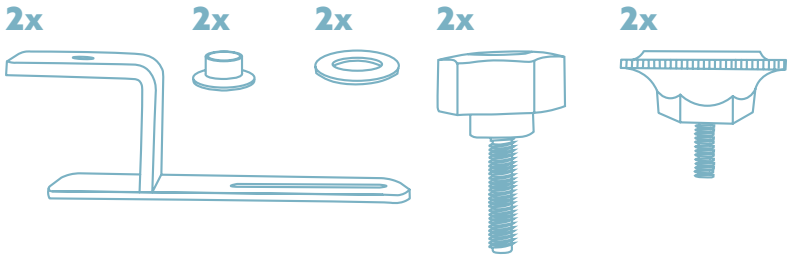
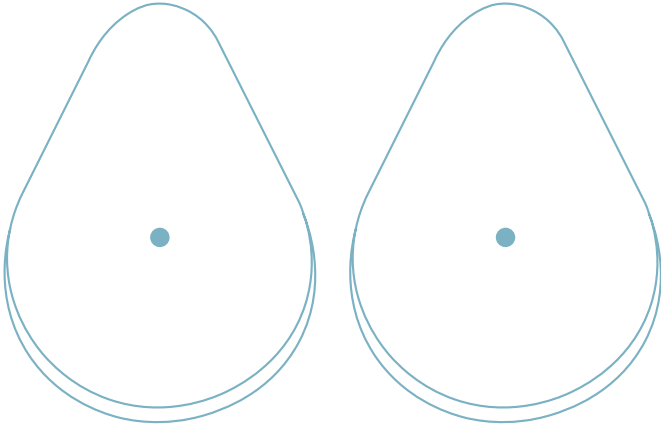

Configuración

Paso A

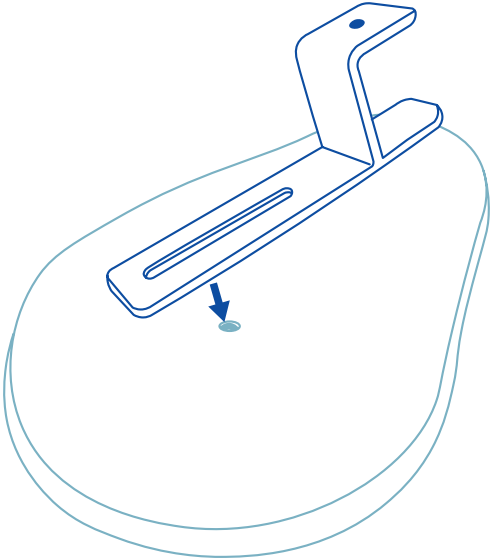

Paso B

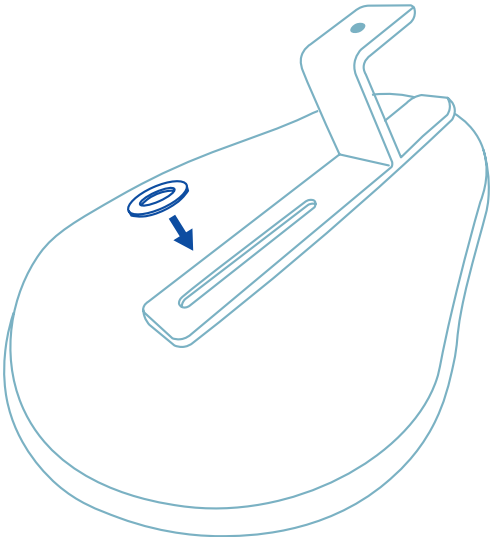

Configuración

Paso C

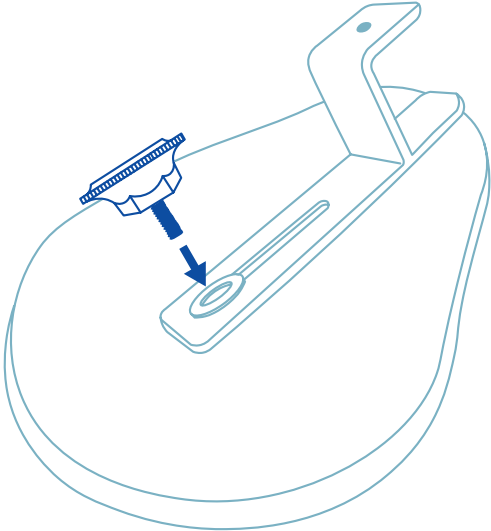

Paso D

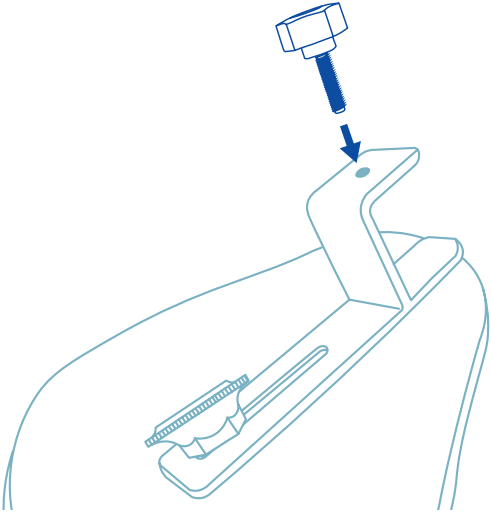

Configuración

Paso E

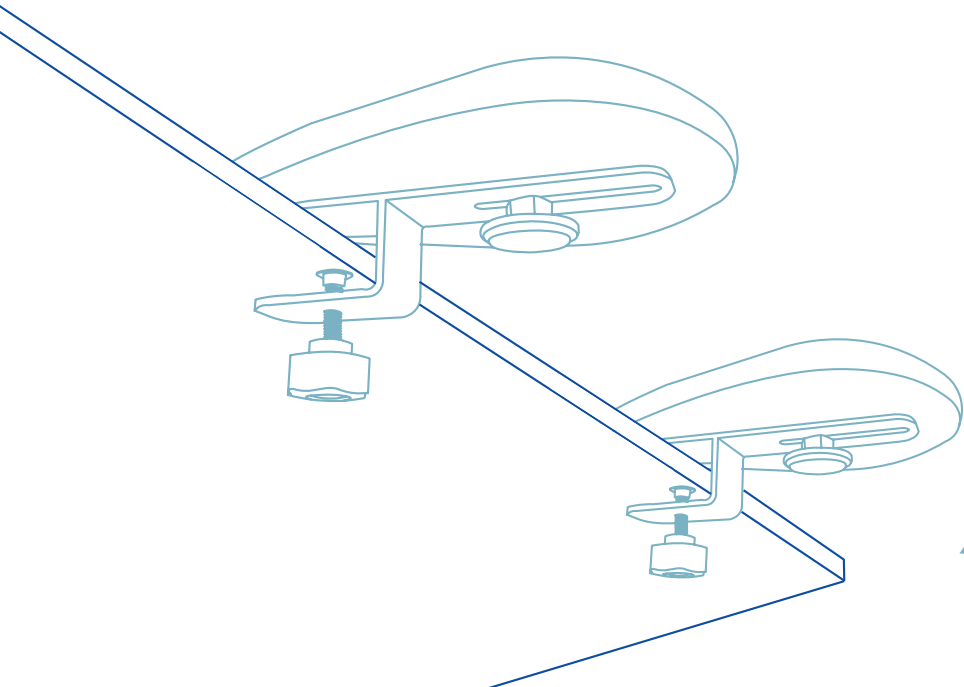
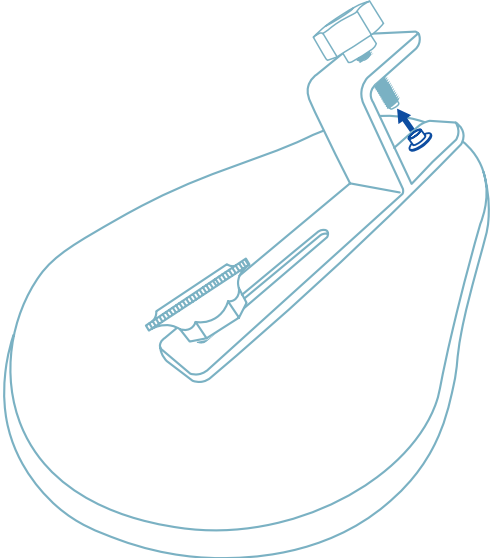

Producto final

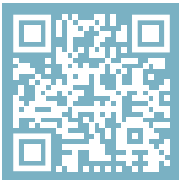
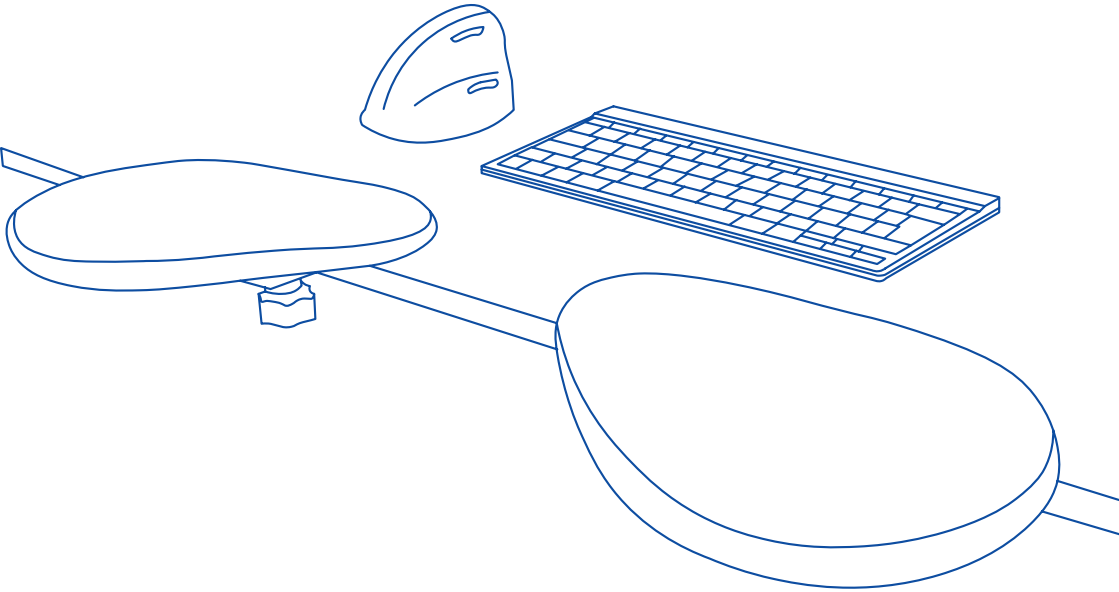

Para más información sobre este producto, ¡escanea el código QR!
https://r-go.tools/arm_web_en

¡Comprueba si encaja!

Se adapta a todas las mesas que cumplen las directrices europeas.

Ten en cuenta que el reposabrazos no se adapta a los siguientes tipos de tableros de mesa:

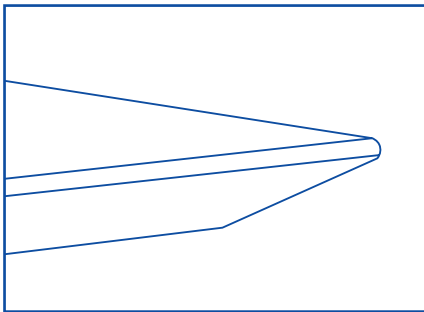

El tablero de la mesa tiene un **borde inclinado**.

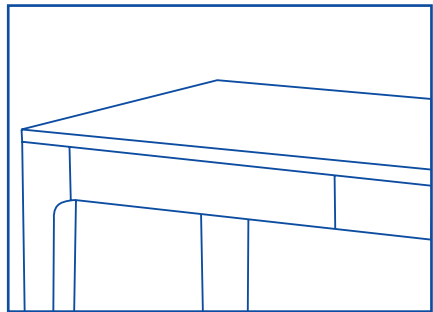

La mesa tiene **cajones**.

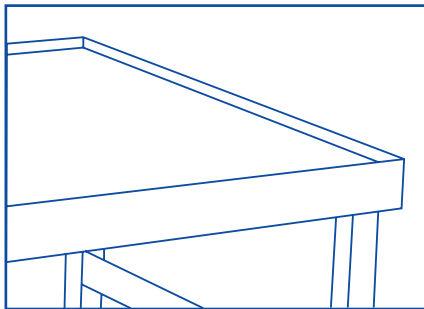

El borde del tablero de la **mesa está elevado**.

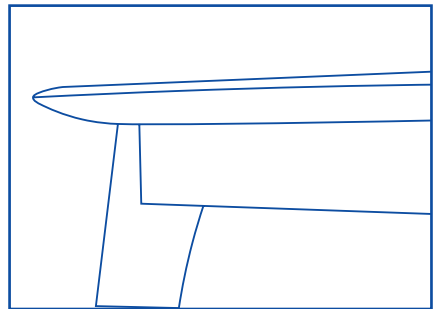

El tablero de la mesa sobresale **menos de 50 mm**.



apoio de braço dividido ergonómico

Apoio de braço R-Go Split

Ergonomische geteilte Armlehne

Accoudoir ergonomique divisé

Visão geral do produto

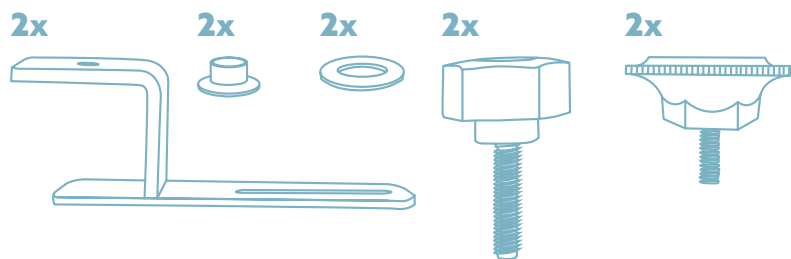
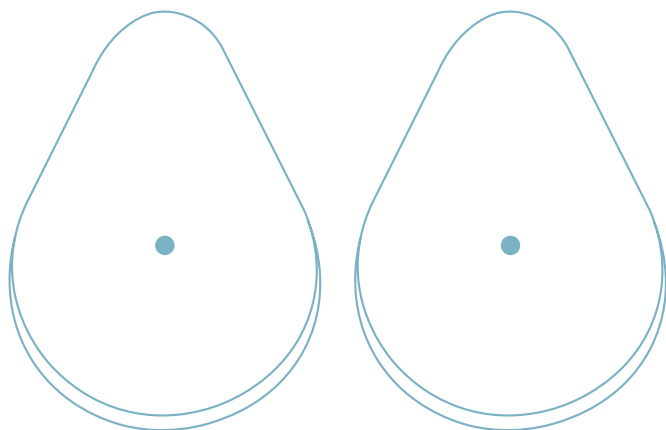

Configurações

Passo A

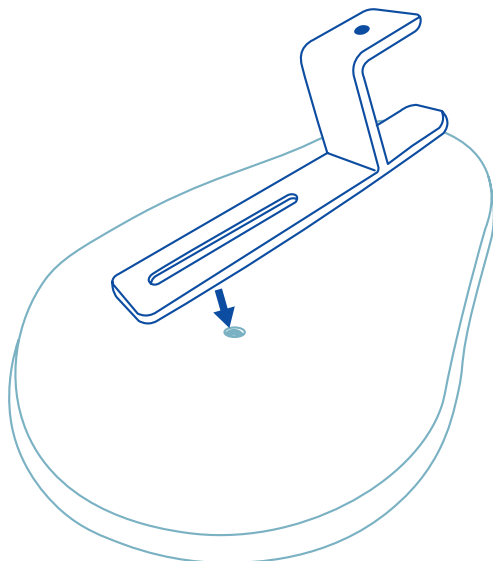

Passo B

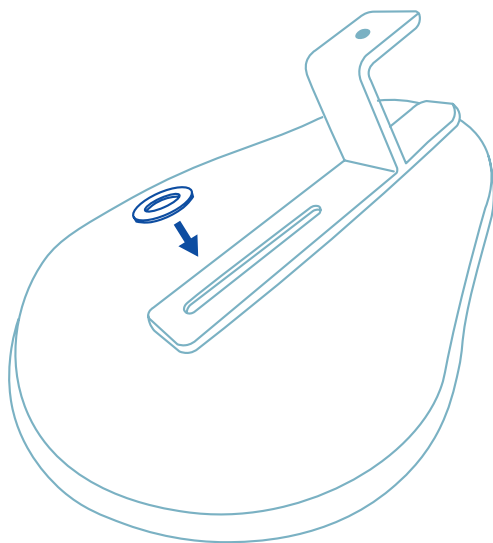

Configurações

Passo C

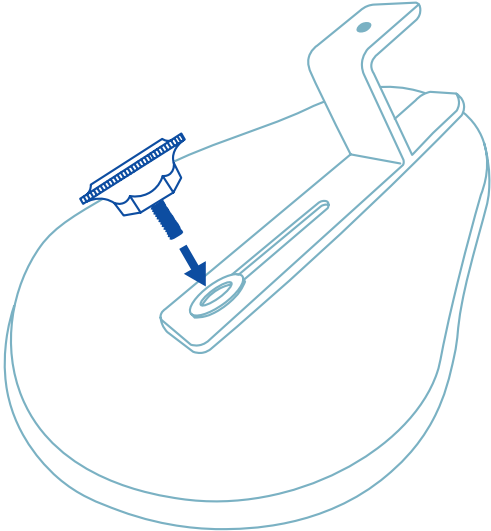

Passo D

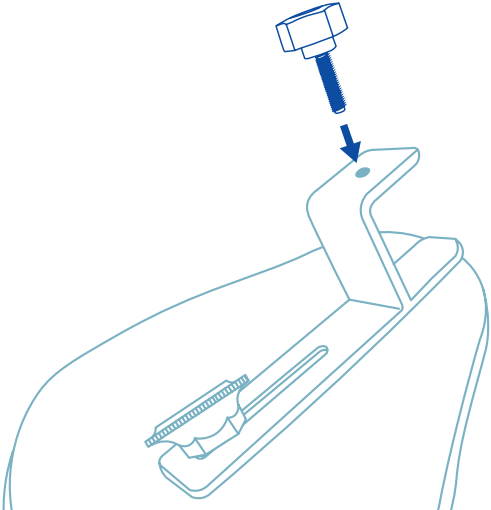

Configurações

Passo E

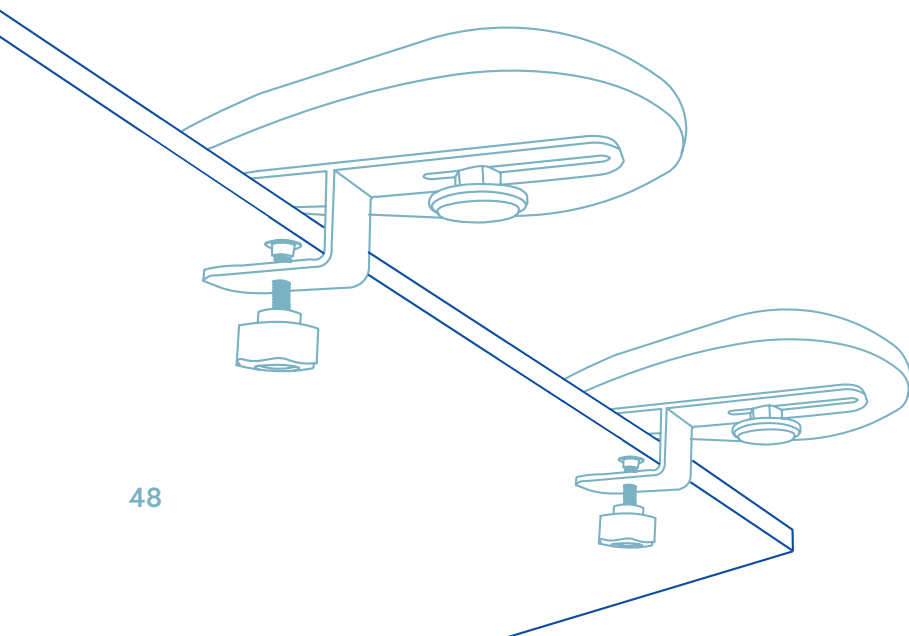
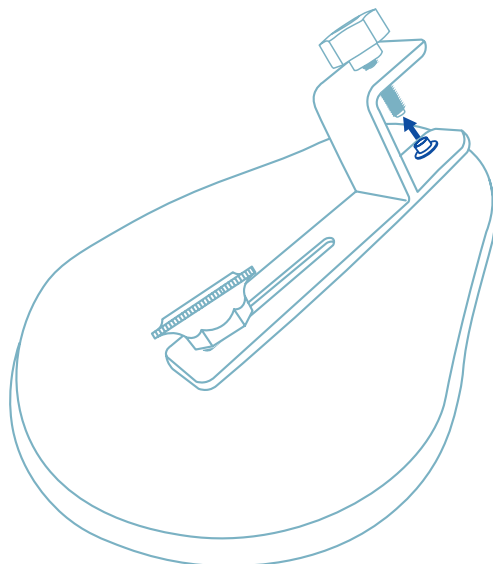

Produto final

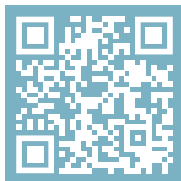
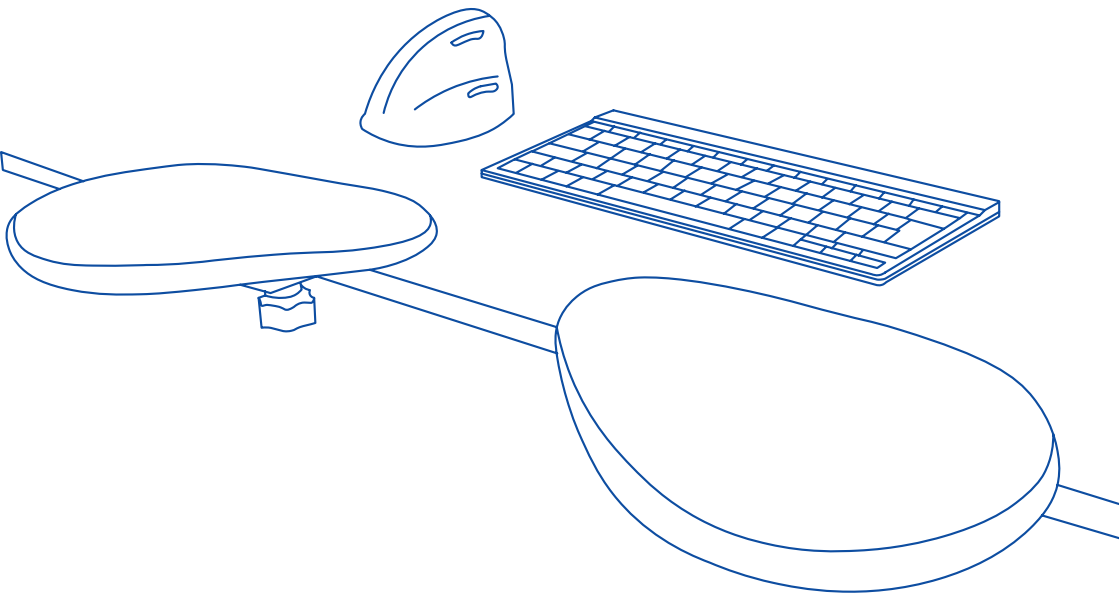

Para mais informações sobre este produto, lê o código QR!
https://r-go.tools/arm_web_en

Verifica se serve!

Adapta-se a todas as secretárias que cumpram as directrizes europeias.

Tem em atenção que o apoio de braço não se adapta aos seguintes tipos de tampos de mesa:

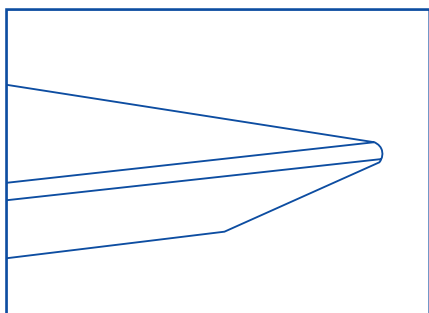

O tampo da mesa tem um **rebordo inclinado**.

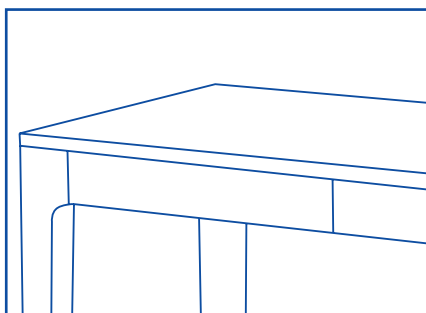

A mesa tem **gavetas**.

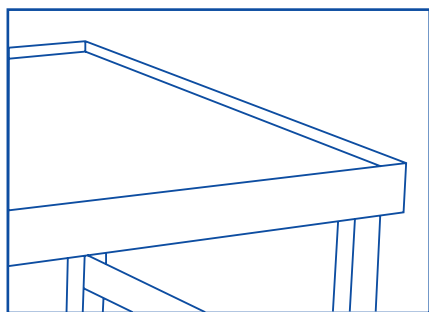

A borda do tampo da mesa é **elevada**.

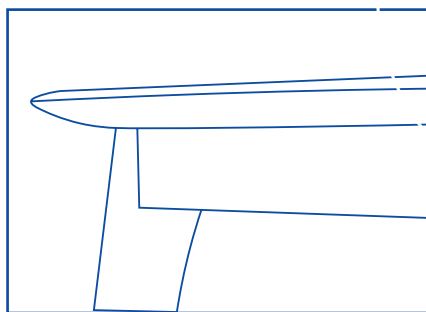

O tampo de mesa saliente é **inferior a 50 mm**.



bracciolo ergonomico diviso in due

Bracciolo R-Go Split

Ergonomische geteilte Armlehne

Accoudoir ergonomique divisé

Panoramica del prodotto

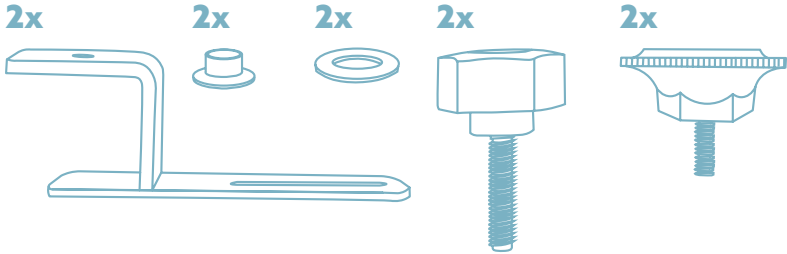
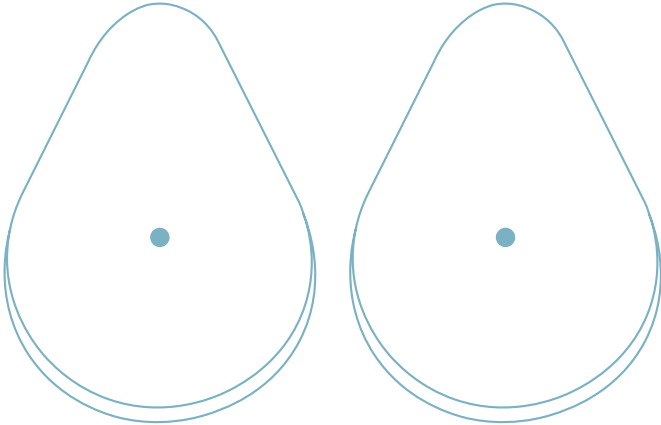

Configurazione

Passo A

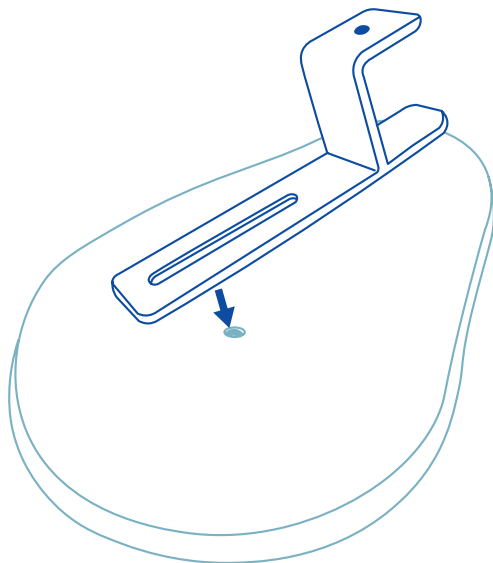

Passo B

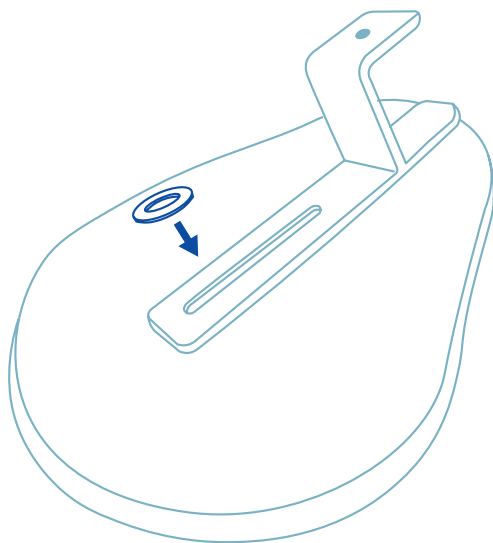

Configurazione

Passo C

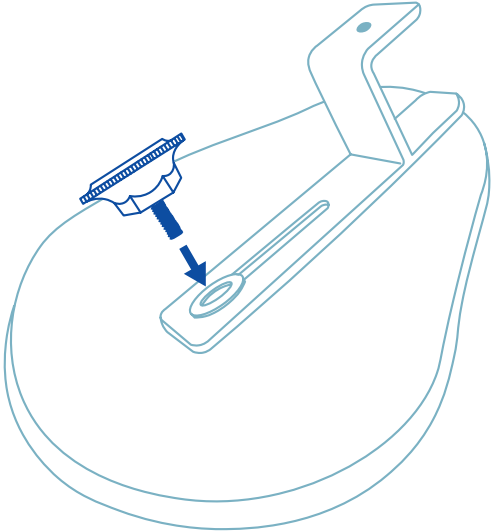

Passo D

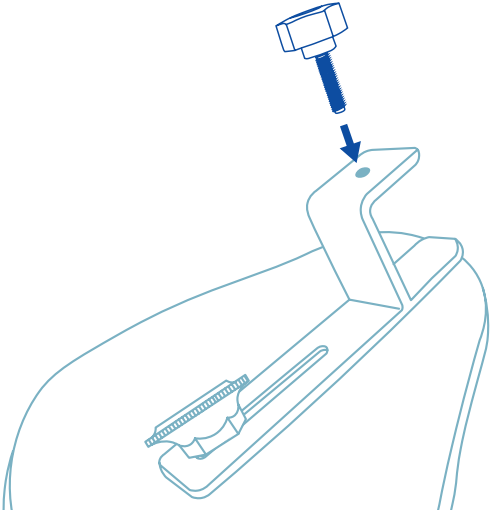

Configurazione

Passo E

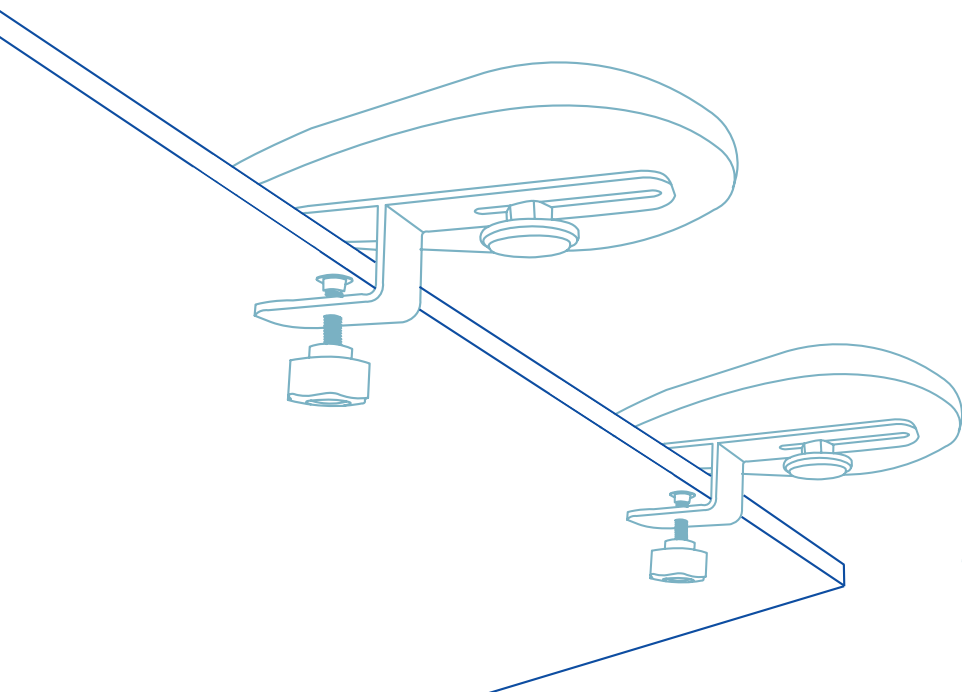
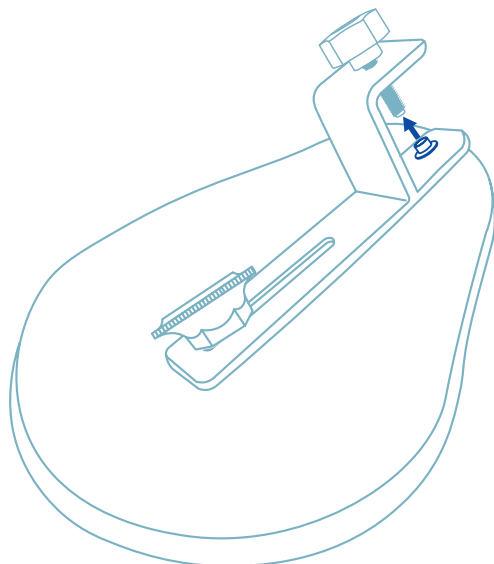

Prodotto finale

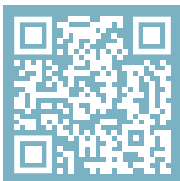
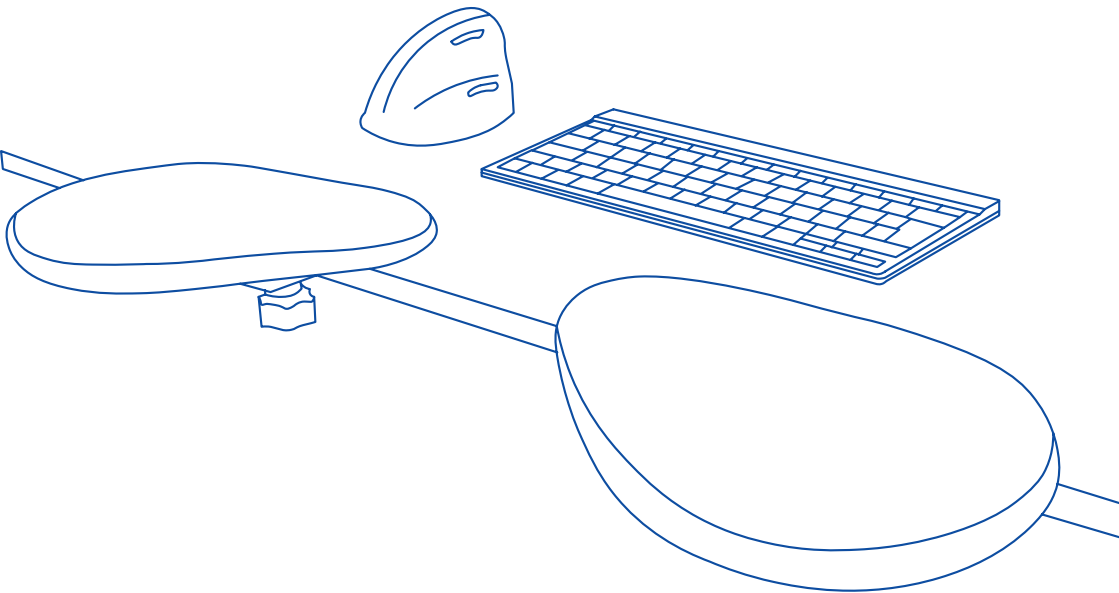

Per maggiori informazioni su questo prodotto, scansiona il codice QR!
https://r-go.tools/arm_web_en

Controlla se è adatto!

Si adatta a tutte le scrivanie conformi alle linee guida europee.

Nota bene: il bracciolo non si adatta ai seguenti tipi di piani d'appoggio:

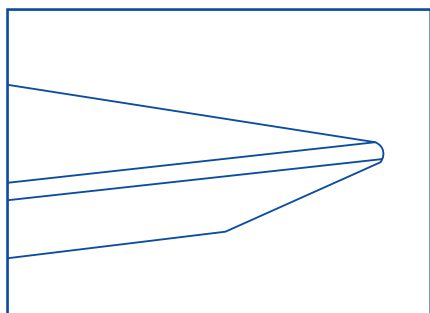

Il piano del tavolo ha un **bordo inclinato**.

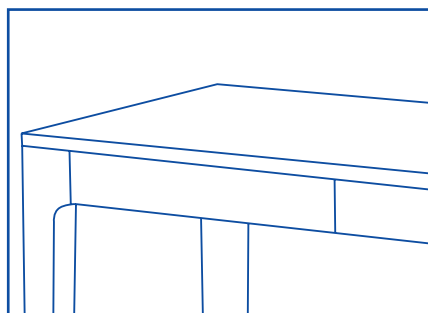

Il tavolo ha dei **cassetti**.

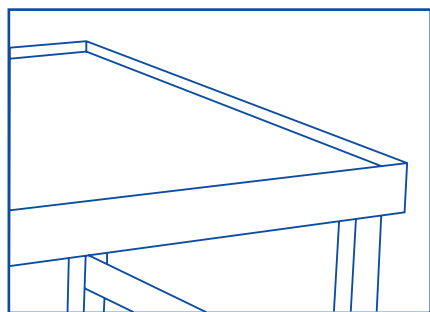

Il bordo del piano del **tavolo è rialzato**.

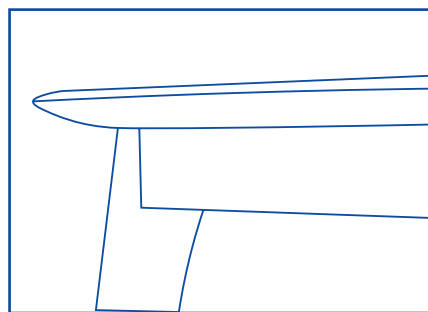

Il piano del tavolo è **più piccolo di 50 mm**.