



PointWrite User Manual



Table of contents

Shipping contents..... 3

**Attaching the
PointWrite to the
projector 4**

**Connecting the
PointWrite to PC..... 5**

Pen action 5

Exchanging the pen tip 5

Driver Installation 6

Configuration setting... 8

The PointWrite configuration..... 8

Alignment View 9





PointWrite Calibration 10

**Running the
PointWrite..... 12**

Specifications..... 13

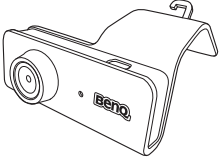
Shipping contents

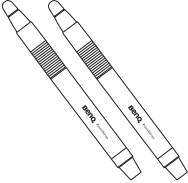
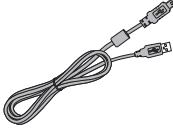
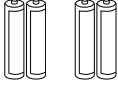
The PointWrite is a built in Interactive Whiteboard on the projector. To use the PointWrite correctly, please find the standard accessories below and follow the instructions in this manual.

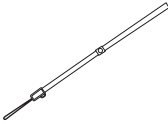
1	2	3
		
PointWrite	Installation CD	Quick manual
4	5	6
		
Two PointWrite pens	Mini USB cable	Two sets of batteries
7	8	9
		
Extra pen tips	Screws	Wrist strip

1. PointWrite: Interactive Whiteboard Sensor.
2. Installation CD: CD contains PointWrite driver, QWrite software and user manual.
3. Quick Start Guide: Short cut of how to use the PointWrite.
4. Two PointWrite Pens: PointWrite Pen is a pen type wireless mouse. Before using the pen, insert the batteries into the pen.
5. Mini USB Cable: Connects the PointWrite to PC.
6. Batteries: AAA size batteries.
7. Extra Pen Tip: 5 extra pen tips.
8. Screws: One extra screw is in reserve.
9. Wrist strip

Caution: When inserting the batteries into the PointWrite Pen, make sure the battery polarities are correct.



Attaching the PointWrite to the projector

Attach the PointWrite to the projector as illustrated and tighten the screw to secure the PointWrite.

1. Attach the PointWrite to the projector as illustrated.

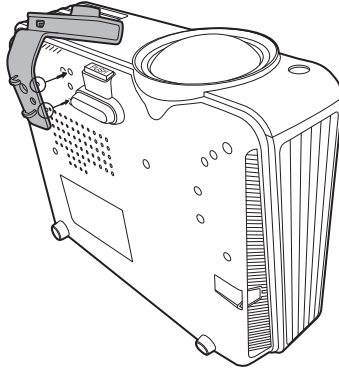

2. Tighten the screw to secure the PointWrite.

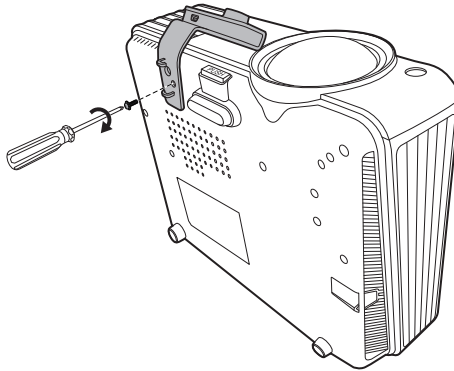

Connecting the PointWrite to PC

Use the USB cable¹ to connect the PointWrite to PC. Plug the USB mini-B end into the PointWrite and plug the USB type-A end into PC.

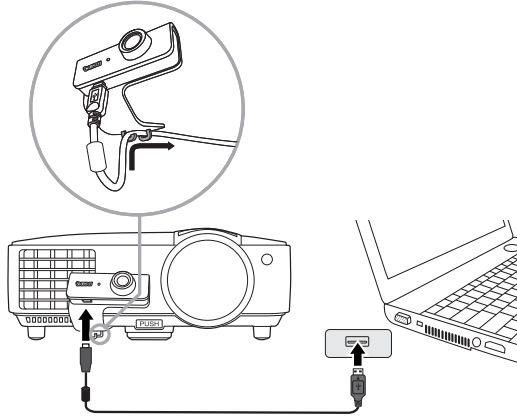

Pen action

The PointWrite Pen provides the following 4 actions:

Click: Touch an icon or a menu on the screen.

Double Click: Touch an icon or a menu on the screen two times.

Right Button Click: Touch an icon or menu for at least 1.5 seconds.

Drag: Touch and drag an object on the screen.

Exchanging the pen tip

1. Removing the pen tip
Hold the pen tip with your fingers. Shake and pull the pen tip out of the pen.
2. Inserting the pen tip
Push the pen tip gently, but not abruptly.

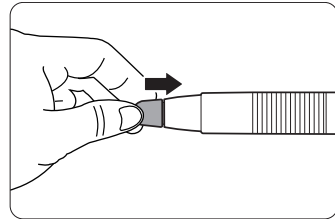
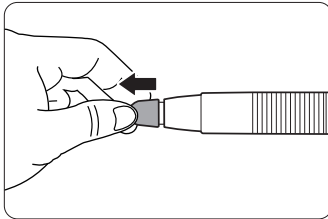

¹: A USB cable of 5 meters is provided. Use a USB repeater cable if you need to extend the length.

Driver Installation

Insert the PointWrite CD into your CD/DVD-ROM driver. The Installation assistant will run automatically. Follow the instructions on the screen. If the assistant does not run automatically, double click on the “setup.exe” under CD/DVD-ROM directory and the Installation assistant will display.

1. Click Install PointWrite in the installation assistant.

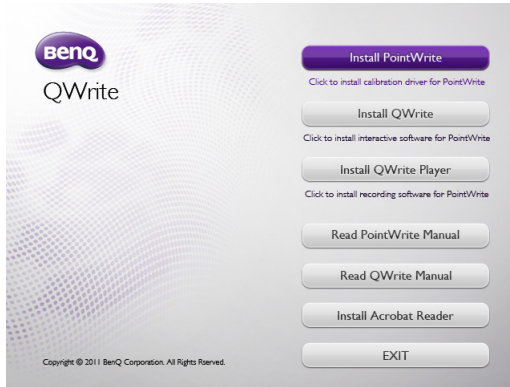

2. Select a language and click “OK”.



3. The installation dialog box will appear. Click next. During the installation process, it is recommended to close other applications.

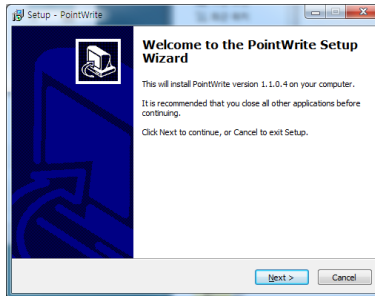

4. Click **Install**, the installation begins.

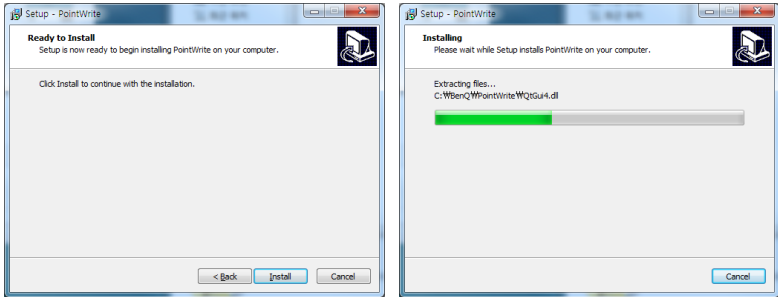

5. The installation ends and a dialog box will appear. Click “Finish”.

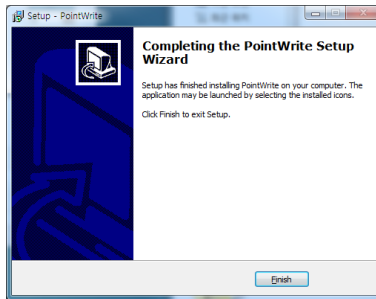

After the installation is finished,

- The PointWrite icon will be created on the desktop.
- The installation folder will be created on C: directory.
- When running the PointWrite², the PointWrite icon appears on the system tray area.
- Click on the PointWrite icon on system tray area and a popup menu will appear.

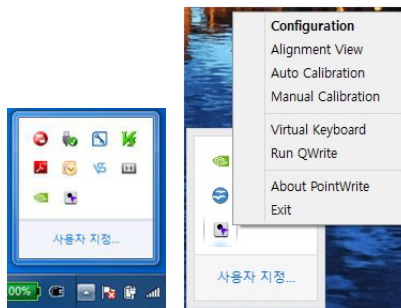

2. When using the PointWrite for the first time, the configuration window will appear on the desktop to help you configure the PointWrite.

Configuration setting

The PointWrite configuration

To use the PointWrite, the proper setting of the PointWrite configuration is needed. The Configuration setting window will help you to set up PointWrite correctly.

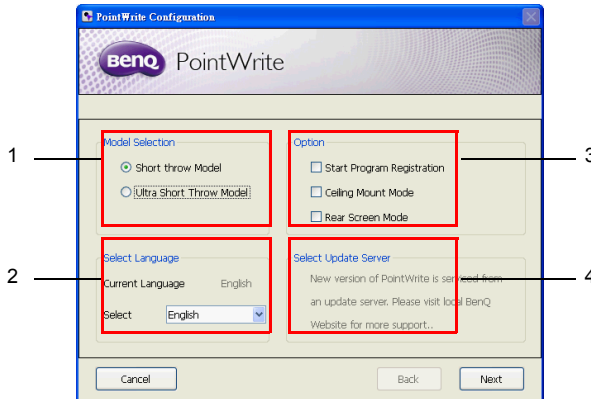

1. **PointWrite configuration:** Adjust the setting according to your projector.
2. **PointWrite Language:** The default language is the same as the language for your operating system. If you want to change the language, click on **Select** **English** and then language list will display. **After selecting your preferred language, quit the PointWrite and start the PointWrite again.**
3. **PointWrite Option:**
 - **Start Program Registration:** Click this item if you want the PointWrite to run automatically when Windows starts.
 - **Ceiling Mount Mode:** Click this item if you mount the projector on the ceiling. When the projector is placed on the table, do not click this item.
 - **Rear Screen Mode:** If the projector is installed on the rear screen system, click this item.
4. **Select Update Server:** Please visit local BenQ Website for more support.

Alignment View

The PointWrite Alignment function is to set the orientation of the PointWrite to the screen.

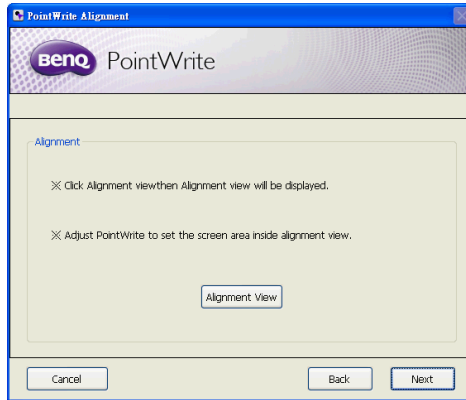

Alignment View: When clicking on the “Alignment View”, the screen image is displayed on the alignment view box (central black box).



If the screen image is not in the center, the calibration will fail. Please make sure the PointWrite module is attached to the projector properly.

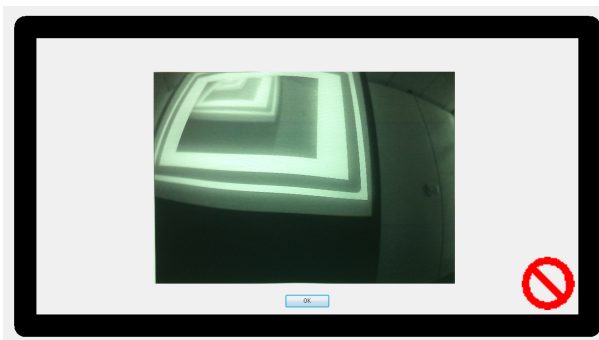

PointWrite Calibration

PointWrite provides two kinds of calibration methods: auto calibration and manual calibration.

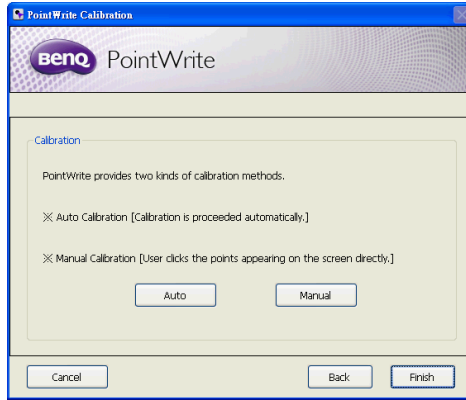

Auto calibration³: click on Auto and the calibration process will run automatically.

When you choose this method, white image is shown on the screen and the pattern image is displayed.

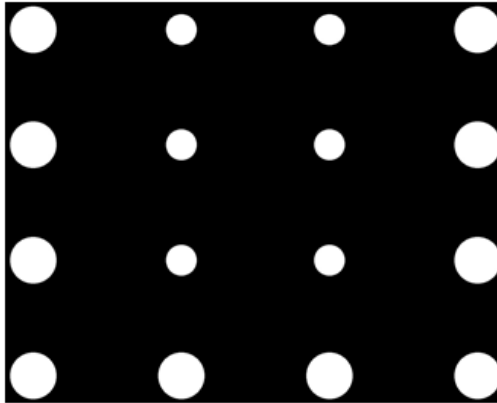

³ In rare circumstances, auto calibration may fail or accuracy may be low. In this case, please execute the manual calibration.

Manual calibration:

Click on and the calibration window will be projected on the screen.

Use the PointWrite pen to click on the center of calibration cursor  immediately after it appears. Then the next cursor will display. Repeat this process until the last calibration cursor disappears.

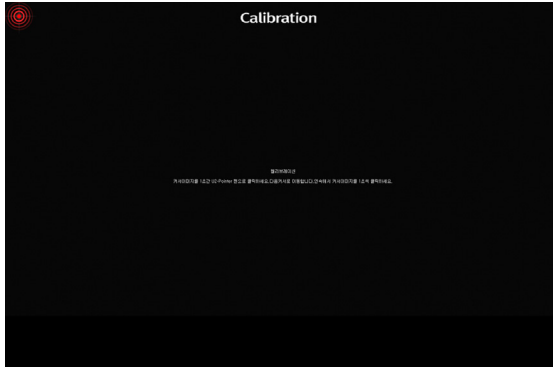

PointWrite pull-up menu

Running the PointWrite

After you double click on the PointWrite icon  on the desktop, the PointWrite will initiate and the PointWrite icon will be created on the system tray area.

Right click on the PointWrite icon on the system tray area and a pull-up menu appears.

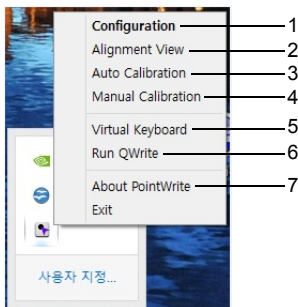

1. **Configuration:** Choose this when you want to change the installation position of the projector. To change the language, click on this menu and follow the steps on [page 8](#).
2. **Alignment View:** See "[Alignment View](#)" on [page 9](#) for details.
3. **Auto Calibration:** If the accuracy is not enough when using the PointWrite, execute the auto calibration again.
4. **Manual Calibration:** If the accuracy is not enough when using the PointWrite or the auto calibration fails, execute the manual calibration.
5. **Virtual Keyboard:** If keyboard input is needed, click on the "Virtual Keyboard" and then keyboard will appear on the screen.
6. **Run QWrite:** Choose this when you want to run the "QWrite".
7. **About PointWrite:** This menu provides the PointWrite version information. Click this menu, and then version information window will appear.

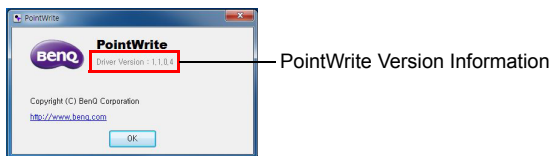

Specifications

Item	Description
PointWrite	
Model name	PW01
Technology	Image Processing Technology
Refresh Rate	60Hz
Response Time	0.016 sec
Auto Calibration	Yes
Calibration Accuracy ^a	Max +/-2 Pixel
Operating Distance	Follow Projector Specification
Multi-User	4 pen simultaneously
Multiple Operation	2 Units
PC Connection	Mini USB
Power Source	PC USB Power
Max USB Cable Length	15 m (5 m USB cable + Repeater)
OS Supported	Windows: WinXP, Vista, 7, 8 Mac: Snow Leopard or later
Storage Temperature	-20°C ~ 60°C
Operating Temperature	5°C ~ 40°C
Dimensions	71 mm x 29 mm x 15.5 mm
Weight	32 g
Compatible model	Selected BenQ short throw models
PointWrite Pen	
Power	AAA Battery*2
Length	176 mm
Diameter	15 mm
Weight	35 g
Color	White

^a. The accuracy of auto calibration will be impacted depending on your environment.